

Calculus-Based Physics I

Jeffrey W. Schnick

Contribution:



Open Educational Resources
UKM Literasi Informasi & Perpustakaan Unsyiah

License : Creative Commons

Calculus-Based Physics I

by Jeffrey W. Schnick

Copyright 2005-2008, Jeffrey W. Schnick, Creative Commons Attribution Share-Alike License 3.0. You can copy, modify, and re-release this work under the same license provided you give attribution to the author. See <http://creativecommons.org/>

This book is dedicated to Marie, Sara, and Natalie.

Table of Contents

1	Mathematical Prelude.....	2
2	Conservation of Mechanical Energy I: Kinetic Energy & Gravitational Potential Energy	10
3	Conservation of Mechanical Energy II: Springs, Rotational Kinetic Energy	18
4	Conservation of Momentum.....	20
5	Conservation of Angular Momentum	25
6	One-Dimensional Motion (Motion Along a Line): Definitions and Mathematics	30
7	One-Dimensional Motion: The Constant Acceleration Equations	39
8	One-Dimensional Motion: Collision Type II	43
9	One-Dimensional Motion Graphs.....	48
10	Constant Acceleration Problems in Two Dimensions	52
11	Relative Velocity.....	62
12	Gravitational Force Near the Surface of the Earth, First Brush with Newton's 2 nd Law.....	69
13	Freefall, a.k.a. Projectile Motion	74
14	Newton's Laws #1: Using Free Body Diagrams	79
15	Newton's Laws #2: Kinds of Forces, Creating Free Body Diagrams.....	86
16	Newton's Laws #3: Components, Friction, Ramps, Pulleys, and Strings.....	95
17	The Universal Law of Gravitation	104
18	Circular Motion: Centripetal Acceleration.....	111
19	Rotational Motion Variables, Tangential Acceleration, Constant Angular Acceleration.....	117
20	Torque & Circular Motion.....	124
21	Vectors: The Cross Product & Torque.....	132
22	Center of Mass, Moment of Inertia.....	142
23	Statics	155
24	Work and Energy	162
25	Potential Energy, Conservation of Energy, Power	171
26	Impulse and Momentum.....	180
27	Oscillations: Introduction, Mass on a Spring	185
28	Oscillations: The Simple Pendulum, Energy in Simple Harmonic Motion	197
29	Waves: Characteristics, Types, Energy.....	202
30	Wave Function, Interference, Standing Waves	218
31	Strings, Air Columns.....	225
32	Beats, The Doppler Effect	233
33	Fluids: Pressure, Density, Archimedes' Principle	239
34	Pascal's Principle, the Continuity Equation, and Bernoulli's Principle.....	247
35	Temperature, Internal Energy, Heat, and Specific Heat Capacity.....	257
36	Heat: Phase Changes	262
37	The First Law of Thermodynamics.....	266

1 Mathematical Prelude

Just below the title of each chapter is a tip on what I perceive to be the most common mistake made by students in applying material from the chapter. I include these tips so that you can avoid making the mistakes. Here's the first one:

The reciprocal of $\frac{1}{x} + \frac{1}{y}$ is not $x + y$. Try it in the case of some simple numbers.

Suppose $x=2$ and $y=4$. Then $\frac{1}{x} + \frac{1}{y} = \frac{1}{2} + \frac{1}{4} = \frac{2}{4} + \frac{1}{4} = \frac{3}{4}$ and the reciprocal

of $\frac{3}{4}$ is $\frac{4}{3}$ which is clearly not 6 (which is what you obtain if you take the

reciprocal of $\frac{1}{2} + \frac{1}{4}$ to be $2+4$). So what is the reciprocal of $\frac{1}{x} + \frac{1}{y}$? The

reciprocal of $\frac{1}{x} + \frac{1}{y}$ is $\frac{1}{\frac{1}{x} + \frac{1}{y}}$.

This book is a physics book, not a mathematics book. One of your goals in taking a physics course is to become more proficient at solving physics problems, both conceptual problems involving little to no math, and problems involving some mathematics. In a typical physics problem you are given a description about something that is taking place in the universe and you are supposed to figure out and write something very specific about what happens as a result of what is taking place. More importantly, you are supposed to communicate clearly, completely, and effectively, how, based on the description and basic principles of physics, you arrived at your conclusion. To solve a typical physics problem you have to: (1) form a picture based on the given description, quite often a moving picture, in your mind, (2) concoct an appropriate mathematical problem based on the picture, (3) solve the mathematical problem, and (4) interpret the solution of the mathematical problem. The physics occurs in steps 1, 2, and 4. The mathematics occurs in step 3. It only represents about 25% of the solution to a typical physics problem.

You might well wonder why we start off a physics book with a chapter on mathematics. The thing is, the mathematics covered in this chapter is mathematics you are supposed to already know. The problem is that you might be a little bit rusty with it. We don't want that rust to get in the way of your learning of the physics. So, we try to knock the rust off of the mathematics that you are supposed to already know, so that you can concentrate on the physics.

As much as we emphasize that this is a physics course rather than a mathematics course, there is no doubt that you will advance your mathematical knowledge if you take this course seriously. You will use mathematics as a tool, and as with any tool, the more you use it the better you get at using it. Some of the mathematics in this book is expected to be new to you. The mathematics that is expected to be new to you will be introduced in recitation on an as-needed basis. It is anticipated that you will learn and use some calculus in this course before you ever see it in a mathematics course. (This book is addressed most specifically to students who have never had a

physics course before and have never had a calculus course before but are currently enrolled in a calculus course. If you have already taken calculus, physics, or both, then you have a well-earned advantage.)

Two points of emphasis regarding the mathematical component of your solutions to physics problems that have a mathematical component are in order:

- (1) You are required to present a clear and complete analytical solution to each problem. This means that you will be manipulating symbols (letters) rather than numbers.
- (2) For any physical quantity, you are required to use the symbol which is conventionally used by physicists, and/or a symbol chosen to add clarity to your solution. In other words, it is not okay to use the symbol x to represent every unknown.

Aside from the calculus, here are some of the kinds of mathematical problems you have to be able to solve:

Problems Involving Percent Change

A cart is traveling along a track. As it passes through a **photogate**¹ its speed is measured to be 3.40 m/s. Later, at a second photogate, the speed of the cart is measured to be 3.52 m/s. Find the percent change in the speed of the cart.

The percent change in anything is the change divided by the *original*, all times 100%. (I've emphasized the word "original" because the most common mistake in these kinds of problems is dividing the change by the wrong thing.)

The change in a quantity is *the new value minus the original value*. (The most common mistake here is reversing the order. If you forget which way it goes, think of a simple problem for which you know the answer and see how you must arrange the new and original values to make it come out right. For instance, suppose you gained 2 kg over the summer. You know that the change in your mass is +2 kg. You can calculate the difference both ways—we're talking trial and error with at most two trials. You'll quickly find out that it is "the new value minus the original value" a.k.a. "final minus initial" that yields the correct value for the change.)

Okay, now let's solve the given problem

$$\% \text{ Change} = \frac{\text{change}}{\text{original}} 100 \% \quad (1-1)$$

Recalling that the change is the new value minus the original value we have

¹ A photogate is a device that produces a beam of light, senses whether the beam is blocked, and typically sends a signal to a computer indicating whether the beam is blocked or not. When a cart passes through a photogate, it temporarily blocks the beam. The computer can measure the amount of time that the beam is blocked and use that and the known length of the cart to determine the speed of the cart as it passes through the photogate.

$$\% \text{ Change} = \frac{\text{new} - \text{original}}{\text{original}} 100\% \quad (1-2)$$

While it's certainly okay to memorize this by accident because of familiarity with it, you should concentrate on being able to derive it using common sense (rather than working at memorizing it).

Substituting the given values for the case at hand we obtain

$$\% \text{ Change} = \frac{3.52 \frac{m}{s} - 3.40 \frac{m}{s}}{3.40 \frac{m}{s}} 100\%$$

$$\% \text{ Change} = 3.5\%$$

Problems Involving Right Triangles

Example 1-1: The length of the shorter side of a right triangle is x and the length of the hypotenuse is r . Find the length of the longer side and find both of the angles, aside from the right angle, in the triangle.

Solution:

Draw the triangle such that it is obvious which side is the shorter side →

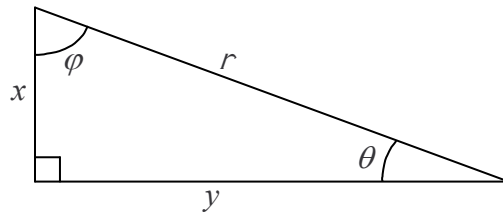

Pythagorean Theorem → $r^2 = x^2 + y^2$

Subtract x^2 from both sides of the equation → $r^2 - x^2 = y^2$

Swap sides → $y^2 = r^2 - x^2$

Take the square root of both sides of the equation → $y = \sqrt{r^2 - x^2}$

By definition, the sine of θ is the side opposite θ divided by the hypotenuse → $\sin \theta = \frac{x}{r}$

Take the arcsine of both sides of the equation in order to get θ by itself → $\theta = \sin^{-1} \frac{x}{r}$

By definition, the cosine of ϕ is the side adjacent to ϕ divided by the hypotenuse → $\cos \phi = \frac{x}{r}$

Take the arccosine of both sides of the equation in order to get ϕ by itself → $\phi = \cos^{-1} \frac{x}{r}$

To solve a problem like the one above, you need to memorize the relations between the sides and the angles of a right triangle. A convenient **mnemonic**² for doing so is “SOHCAHTOA” pronounced as a single word.

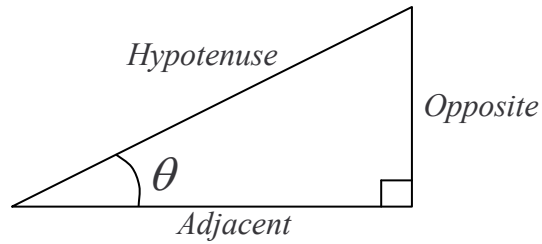

Referring to the diagram above right:

$$\text{SOH reminds us that: } \sin \theta = \frac{\textit{Opposite}}{\textit{Hypotenuse}} \quad (1-3)$$

$$\text{CAH reminds us that: } \cos \theta = \frac{\textit{Adjacent}}{\textit{Hypotenuse}} \quad (1-4)$$

$$\text{TOA reminds us that: } \tan \theta = \frac{\textit{Opposite}}{\textit{Adjacent}} \quad (1-5)$$

Points to remember:

1. The angle θ is never the 90 degree angle.
2. The words “opposite” and “adjacent” designate sides relative to the angle. For instance, the cosine of θ is the length of the side adjacent to θ divided by the length of the hypotenuse.

You also need to know about the arcsine and the arccosine functions to solve the example problem above. The arcsine function is the inverse of the sine function. The answer to the question, “What is the arcsine of 0.44?” is, “that angle whose sine is 0.44 .” There is an arcsine button on your calculator. It is typically labeled \sin^{-1} , to be read, “arcsine.” To use it you probably have to hit the inverse button or the second function button on your calculator first.

The inverse function of a function undoes what the function does. Thus:

$$\sin^{-1} \sin \theta = \theta \quad (1-6)$$

Furthermore, the sine function is the inverse function to the arcsine function and the cosine function is the inverse function to the arccosine function. For the former, this means that:

$$\sin(\sin^{-1} x) = x \quad (1-7)$$

² A mnemonic is something easy to remember that helps you remember something that is harder to remember.

Problems Involving the Quadratic Formula

First comes the quadratic equation, then comes the quadratic formula. The quadratic formula is the solution to the **quadratic equation**:

$$ax^2 + bx + c = 0 \quad (1-8)$$

in which:

x is the variable whose value is sought, and
 a , b , and c are constants

The goal is to find the value of x that makes the left side 0. That value is given by the **quadratic formula**:

$$x = \frac{-b \pm \sqrt{b^2 - 4ac}}{2a} \quad (1-9)$$

to be read/said:

' x ' equals minus ' b ', plus-or-minus the square root of ' b ' squared minus four ' a ' ' c ', **all** over two ' a '.

So, how do you know when you have to use the quadratic formula? There is a good chance that you need it when the square of the variable for which you are solving, appears in the equation you are solving. When that is the case, carry out the algebraic steps needed to arrange the terms as they are arranged in equation 1-8 above. If this is impossible, then the quadratic formula is not to be used. Note that in the quadratic equation you have a term with the variable to the second power, a term with the variable to the first power, and a term with the variable to the zeroth power (the constant term). If additional powers also appear, such as the one-half power (the square root), or the third power, then the quadratic formula does not apply. If the equation includes additional terms in which the variable whose value is sought appears as the argument of a special function such as the sine function or the exponential function, then the quadratic formula does not apply. Now suppose that there is a square term and you can get the equation that you are solving in the form of equation 1-8 above but that either b or c is zero. In such a case, you can use the quadratic formula, but it is overkill. If b in equation 1-8 above is zero then the equation reduces to

$$ax^2 + bx = 0$$

The easy way to solve this problem is to recognize that there is at least one x in each term, and to factor the x out. This yields:

$$(ax + b)x = 0$$

Then you have to realize that a product of two multiplicands is equal to zero if either multiplicand is equal to zero. Thus, setting either multiplicand equal to zero and solving for x yields a solution. We have two multiplicands involving x , so, there are two solutions to the

equation. The second multiplicand in the expression $(ax + b)x = 0$ is x itself, so

$$x = 0$$

is a solution to the equation. Setting the first term equal to zero gives:

$$ax + b = 0$$

$$ax = -b$$

$$x = -\frac{b}{a}$$

Now suppose the b in the quadratic equation $ax^2 + bx + c = 0$, equation 1-8, is zero. In that case, the quadratic equation reduces to:

$$ax^2 + c = 0$$

which can easily be solved without the quadratic formula as follows:

$$ax^2 = -c$$

$$x^2 = -\frac{c}{a}$$

$$x = \pm \sqrt{-\frac{c}{a}}$$

where we have emphasized the fact that there are two square roots to every value by placing a plus-or-minus sign in front of the radical.

Now, if upon arranging the given equation in the form of the *quadratic equation* (equation 1-8):

$$ax^2 + bx + c = 0$$

you find that a , b , and c are all non-zero, then you should use the quadratic formula. Here we present an example of a problem whose solution involves the quadratic formula:

Example 1-2: Quadratic Formula Example Problem

Given

$$3 + x = \frac{24}{x + 1} \quad (1-10)$$

find x .

At first glance, this one doesn't look like a quadratic equation, but as we begin isolating x , as we always strive to do in solving for x , (hey, once we have x all by itself on the left side of the equation, with no x on the right side of the equation, we have indeed solved for x —that's what it means to solve for x) we quickly find that it is a quadratic equation.

Whenever we have the unknown in the denominator of a fraction, the first step in isolating that unknown is to multiply both sides of the equation by the denominator. In the case at hand, this yields

$$(x + 1)(3 + x) = 24$$

Multiplying through on the left we find

$$3x + 3 + x^2 + x = 24$$

At this point it is pretty clear that we are dealing with a quadratic equation so our goal becomes getting it into the standard form of the quadratic equation, the form of equation 1-8, namely: $ax^2 + bx + c = 0$. Combining the terms involving x on the left and rearranging we obtain

$$x^2 + 4x + 3 = 24$$

Subtracting 24 from both sides yields

$$x^2 + 4x - 21 = 0$$

which is indeed in the standard quadratic equation form. Now we just have to use inspection to identify which values in our given equation are the a , b , and c that appear in the standard quadratic equation (equation 1-8) $ax^2 + bx + c = 0$. Although it is not written, the constant multiplying the x^2 , in the case at hand, is just 1. So we have $a = 1$, $b = 4$, and $c = -21$.

Substituting these values into the quadratic formula (equation 1-9):

$$x = \frac{-b \pm \sqrt{b^2 - 4ac}}{2a}$$

yields

$$x = \frac{-4 \pm \sqrt{4^2 - 4(1)(-21)}}{2(1)}$$

which results in

$$x = 3, \quad x = -7$$

as the solutions to the problem. As a quick check we substitute each of these values back into the original equation, equation 1-10:

$$3 + x = \frac{24}{x + 1}$$

and find that each substitution leads to an identity. (An identity is an equation whose validity is trivially obvious, such as $6 = 6$.)

This chapter does not cover all the non-calculus mathematics you will encounter in this course. I've kept the chapter short so that you will have time to read it all. If you master the concepts in this chapter (or re-master them if you already mastered them in high school) you will be on your way to mastering all the non-calculus mathematics you need for this course. Regarding reading it all: By the time you complete your physics course, you are supposed to have read this book from cover to cover. Reading physics material that is new to you is supposed to be slow going. By the word *reading* in this context, we really mean *reading with understanding*. Reading a physics text involves not only reading but taking the time to make sense of diagrams, taking the time to make sense of mathematical developments, and taking the time to make sense of the words themselves. It involves rereading. The method I use is to push my way through a chapter once, all the way through at a novel-reading pace, picking up as much as I can on the way but not allowing myself to slow down. Then, I really read it. On the second time through I pause and ponder, study diagrams, and ponder over phrases, looking up words in the dictionary and working through examples with pencil and paper as I go. I try not to go on to the next paragraph until I really understand what is being said in the paragraph at hand. That first read, while of little value all by itself, is of great benefit in answering the question, "Where is the author going with this?", while I am carrying out the second read.

2 Conservation of Mechanical Energy I: Kinetic Energy & Gravitational Potential Energy

Physics professors often assign conservation of energy problems that, in terms of mathematical complexity, are very easy, to make sure that students can demonstrate that they know what is going on and can reason through the problem in a correct manner, without having to spend much time on the mathematics. A good before-and-after-picture correctly depicting the configuration and state of motion at each of two well-chosen instants in time is crucial in showing the appropriate understanding. A presentation of the remainder of the conceptual-plus-mathematical solution of the problem starting with a statement in equation form that the energy in the before picture is equal to the energy in the after picture, continuing through to an analytical solution and, if numerical values are provided, only after the analytical solution has been arrived at, substituting values with units, evaluating, and recording the result is almost as important as the picture. The problem is that, at this stage of the course, students often think that it is the final answer that matters rather than the communication of the reasoning that leads to the answer. Furthermore, the chosen problems are often so easy that students can arrive at the correct final answer without fully understanding or communicating the reasoning that leads to it. Students are unpleasantly surprised to find that correct final answers earn little to no credit in the absence of a good correct before-and-after picture and a well-written remainder of the solution that starts from first principles, is consistent with the before and after picture, and leads logically, with no steps omitted, to the correct answer. Note that students who focus on correctly communicating the entire solution, on their own, on every homework problem they do, stand a much better chance of successfully doing so on a test than those that “just try to get the right numerical answer” on homework problems.

Mechanical Energy

Energy is a transferable physical quantity that an object can be said to have. If one transfers energy to a material particle that is initially at rest, the speed of that particle changes to a value which is an indicator of how much energy was transferred. Energy has units of joules, abbreviated J. Energy can't be measured directly but when energy is transferred to or from an object, some measurable characteristic (or characteristics) of that object changes (change) such that, measured values of that characteristic or those characteristics (in combination with one or more characteristics such as mass that do not change by any measurable amount) can be used to determine how much energy was transferred. Energy is often categorized according to which measurable characteristic changes when energy is transferred. In other words, we categorize energy in accord with the way it reveals itself to us. For instance, when the measurable characteristic is temperature, we call the energy thermal energy; when the measurable quantity is speed, we call the energy kinetic energy. While it can be argued that there is only one form or kind of energy, in the jargon of physics we call the energy that reveals itself one way one kind or form of energy (such as thermal energy) and the energy that reveals itself another way another kind or form of energy (such as kinetic energy). In physical processes it often occurs that the

way in which energy is revealing itself changes. When that happens we say that energy is transformed from one kind of energy to another.

Kinetic Energy is energy of motion. An object at rest has no motion; hence, it has no kinetic energy. The kinetic energy K of a non-rotating rigid object in motion depends on the mass m and speed v of the object **as follows**¹:

$$K = \frac{1}{2}mv^2 \quad (2-1)$$

The mass m of an object is a measure of the object's inertia, the object's inherent tendency to maintain a constant velocity. The inertia of an object is what makes it hard to get that object moving. The words "mass" and "inertia" both mean the same thing. Physicists typically use the word "inertia" when talking about the property in general conceptual terms, and the word "mass" when they are assigning a value to it, or using it in an equation. Mass has units of kilograms, abbreviated kg. The speed v has units of meters per second, abbreviated m/s. Check out the units in equation 2-1:

$$K = \frac{1}{2}mv^2$$

On the left we have the kinetic energy which has units of joules. On the right we have the product of a mass and the square of a velocity. Thus the units on the right are $\text{kg} \frac{\text{m}^2}{\text{s}^2}$ and we can deduce that a joule is a $\text{kg} \frac{\text{m}^2}{\text{s}^2}$.

Potential Energy is energy that depends on the arrangement of matter. Here, we consider one type of potential energy:

The *Gravitational Potential Energy of an object*² near the surface of the earth is the energy (relative to the gravitational potential energy that the object has when it is at the reference level about to me mentioned) that the object has because it is "up high" above a reference level such as the ground, the floor, or a table top. In characterizing the relative gravitational potential energy of an object it is important to specify what you are using for a reference level. In using the concept of near-earth gravitational potential energy to solve a physics problem, although you are free to choose whatever you want to as a reference level, it is important to stick with one and the same reference level throughout the problem. The relative gravitational potential energy U_g of

¹ In classical physics we deal with speeds much smaller than the speed of light $c = 3.00 \times 10^8 \text{m/s}$. The classical physics expression $K = \frac{1}{2}mv^2$ is an approximation (a fantastic approximation at speeds much smaller than the speed

of light—the smaller the better) to the relativistic expression $K = (1/\sqrt{1-v^2/c^2} - 1)mc^2$ which is valid for all speeds.

² We call the potential energy discussed here the gravitational potential energy "of the object." Actually, it is the gravitational potential energy of the object-plus-earth system taken as a whole. It would be more accurate to ascribe the potential energy to the gravitational field of the object and the gravitational field of the earth. In lifting an object, it is as if you are stretching a weird invisible spring—weird in that it doesn't pull harder the more you stretch it as an ordinary spring does—and the energy is being stored in that invisible spring. For energy accounting purposes however, it is easier to ascribe the gravitational potential energy of an object near the surface of the earth, to the object, and that is what we do in this book. This is similar to calling the gravitational force exerted on an object by the earth's gravitational field the "weight of the object" as if it were a property of the object, rather than what it really is, an external influence acting on the object.

an object near the surface of the earth depends on the object's height y above the chosen reference level, the object's mass m , and the magnitude g of the earth's gravitational field, which to a good approximation has the same value $g = 9.80 \frac{\text{N}}{\text{kg}}$ everywhere near the surface of the earth, as follows:

$$U_g = mgy \quad (2-2)$$

The N in $g = 9.80 \frac{\text{N}}{\text{kg}}$ stands for newtons, the unit of force. (Force is an ongoing push or pull.)

Since it is an energy, the units of U_g are joules, and the units on the right side of equation 2-2, with the height y being in meters, work out to be newtons times meters. Thus a joule must be a newton meter, and indeed it is. Just above we showed that a joule is a $\text{kg} \frac{\text{m}^2}{\text{s}^2}$. If a joule is also

a newton meter then a newton must be a $\text{kg} \frac{\text{m}}{\text{s}^2}$.

A Special Case of the Conservation of Mechanical Energy

Energy is very useful for making predictions about physical processes because it is never created or destroyed. To borrow expressions from economics, that means we can use simple bookkeeping or accounting to make predictions about physical processes. For instance, suppose we create, for purposes of making such a prediction, an imaginary boundary enclosing part of the universe. Then any change in the total amount of energy inside the boundary will correspond exactly to energy transfer through the boundary. If the total energy inside the boundary increases by ΔE , then exactly that same amount of energy ΔE must have been transferred through the boundary into the region enclosed by the boundary from outside that region. And if the total energy inside the boundary decreases by ΔE , then exactly that amount of energy ΔE must have been transferred through the boundary out of the region enclosed by the boundary from inside that region. Oddly enough, in keeping book on the energy in such an enclosed part of the universe, we rarely if ever know or care what the overall total amount of energy is. It is sufficient to keep track of changes. What can make the accounting difficult is that there are so many different ways in which energy can manifest itself (what we call the different "forms" of energy), and there is no simple energy meter that tells us how much energy there is in our enclosed region. Still, there are processes for which the energy accounting is relatively simple. For instance, it is relatively simple when there is no (or negligible) transfer of energy into or out of the part of the universe that is of interest to us, and when there are few forms of energy for which the amount of energy changes.

The two kinds of energy discussed above (the kinetic energy of a rigid non-rotating object and gravitational potential energy) are both examples of mechanical energy, to be contrasted with, for example, thermal energy. Under certain conditions the total mechanical energy of a system of objects does not change even though the configuration of the objects does. This represents a special case of the more general principle of the conservation energy. The conditions under which the total mechanical energy of a system doesn't change are:

- (1) No energy is transferred to or from the surroundings.
- (2) No energy is converted to or from other forms of energy (such as thermal energy).

Consider a couple of processes in which the total mechanical energy of a system does *not* remain the same:

Case #1

A rock is dropped from shoulder height. It hits the ground and comes to a complete stop.

The "system of objects" in this case is just the rock. As the rock falls, the gravitational potential energy is continually decreasing. As such, the kinetic energy of the rock must be continually increasing in order for the total energy to be staying the same. On the collision with the ground, some of the kinetic energy gained by the rock as it falls through space is transferred to the ground and the rest is converted to thermal energy and the energy associated with sound. Neither condition (no transfer and no transformation of energy) required for the total mechanical energy of the system to remain the same is met; hence, it would be incorrect to write an equation setting the initial mechanical energy of the rock (upon release) equal to the final mechanical energy of the rock (after landing).

Can the idea of an unchanging total amount of mechanical energy be used in the case of a falling object? The answer is *yes*. The difficulties associated with the previous process occurred upon collision with the ground. You can use the idea of an unchanging total amount of mechanical energy to say something about the rock *if* you end your consideration of the rock before it hits the ground. For instance, given the height from which it is dropped, you can use the idea of an unchanging total amount of mechanical energy to determine the speed of the rock at the last instant before it strikes the ground. The "last instant before" it hits the ground corresponds to the situation in which the rock has not yet touched the ground but will touch the ground in an amount of time that is too small to measure and hence can be neglected. It is so close to the ground that the distance between it and the ground is too small to measure and hence can be neglected. It is so close to the ground that the additional speed that it would pick up in continuing to fall to the ground is too small to be measured and hence can be neglected. The total amount of mechanical energy does not change during *this* process. It *would* be correct to write an equation setting the initial mechanical energy of the rock (upon release) equal to the final mechanical energy of the rock (at the last instant before collision).

Case #2

A block, in contact with nothing but a sidewalk, slides across the sidewalk.

The total amount of mechanical energy does not remain the same because there is friction between the block and the sidewalk. In any case involving friction, mechanical energy is converted into thermal energy; hence, the total amount of mechanical energy after the sliding, is not equal to the total amount of mechanical energy prior to the sliding.

Applying the Principle of the Conservation of Energy for the Special Case in which the Mechanical Energy of a System does not Change

In applying the principle of conservation of mechanical energy for the special case in which the mechanical energy of a system does not change, you write an equation which sets the total mechanical energy of an object or system objects at one instant in time equal to the total mechanical energy at another instant in time. Success hangs on the appropriate choice of the two instants. The principle applies to all pairs of instants of the time interval during which energy is neither transferred into or out of the system nor transformed into non-mechanical forms. You characterize the conditions at the first instant by means of a "Before Picture" and the conditions at the second instant by means of an "After Picture." In applying the principle of conservation of mechanical energy for the special case in which the mechanical energy of a system does not change, you write an equation which sets the total mechanical energy in the Before Picture equal to the total mechanical energy in the After Picture. (In both cases, the "total" mechanical energy in question is the amount the system has relative to the mechanical energy it would have if all objects were at rest at the reference level.) To do so effectively, it is necessary to sketch a Before Picture and a separate After Picture. After doing so, the first line in one's solution to a problem involving an unchanging total of mechanical energy always reads

$$\text{Energy Before} = \text{Energy After} \quad (2-3)$$

We can write this first line more symbolically in several different manners:

$$E_1 = E_2 \quad \text{or} \quad E_i = E_f \quad \text{or} \quad E = E' \quad (2-4)$$

The first two versions use subscripts to distinguish between "before picture" and "after picture" energies and are to be read "*E*-sub-one equals *E*-sub-two" and "*E*-sub-*i* equals *E*-sub-*f*." In the latter case the symbols *i* and *f* stand for initial and final. In the final version, the prime symbol is added to the *E* to distinguish "after picture" energy from "before picture" energy. The last equation is to be read "*E* equals *E*-prime." (The prime symbol is sometimes used in mathematics to distinguish one variable from another and it is sometimes used in mathematics to signify the derivative with respect to *x*. It is never used to signify the derivative in this book.) The unprimed/prime notation is the notation that will be used in the following example:

Example 2-1: A rock is dropped from a height of 1.6 meters. How fast is the rock falling just before it hits the ground?

Solution: Choose the "before picture" to correspond to the instant at which the rock is released, since the conditions at this instant are specified ("dropped" indicates that the rock was released from rest—its speed is initially zero, the initial height of the rock is given). Choose the "after picture" to correspond to the last instant before the rock makes contact with the ground since the question pertains to a condition (speed) at this instant.

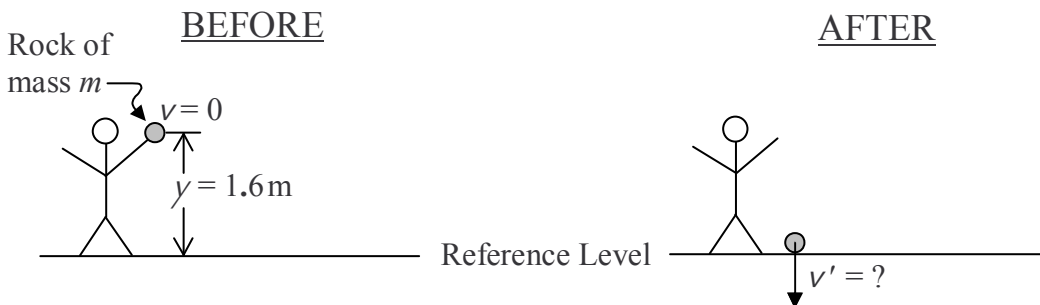

Note that we have omitted the subscript g (for "gravitational") from both U and U' . When you are dealing with only one kind of potential energy, you don't need to use a subscript to distinguish it from other kinds.

$$\begin{aligned}
 E &= E' \\
 \overset{0 \text{ (since at rest)}}{K} + U &= \overset{0 \text{ (since at ground level)}}{K'} + U' \\
 mgy &= \frac{1}{2}mv'^2 \\
 v'^2 &= 2gy \\
 v' &= \sqrt{2gy} \\
 v' &= \sqrt{2(9.80 \text{ m/s}^2)1.6 \text{ m}}
 \end{aligned}$$

$$\boxed{v' = 5.6 \frac{\text{m}}{\text{s}}}$$

Note that the unit, 1 newton, abbreviated as 1 N, is $1 \frac{\text{kg} \cdot \text{m}}{\text{s}^2}$. Hence, the magnitude of the earth's near-surface gravitational field $g = 9.80 \frac{\text{N}}{\text{kg}}$ can also be expressed as $g = 9.80 \frac{\text{m}}{\text{s}^2}$ as we have done in the example for purposes of working out the units.

The solution presented in the example provides you with an example of what is required of students in solving physics problems. In cases where student work is evaluated, it is the solution which is evaluated, not just the final answer. In the following list, general requirements for solutions are discussed, with reference to the solution of the example problem:

1. Sketch (the before and after pictures in the example).
Start each solution with a sketch or sketches appropriate to the problem at hand. Use the sketch to define symbols and, as appropriate, to assign values to symbols. The sketch aids you in solving the problem and is important in communicating your solution to the reader. Note that each sketch depicts a configuration at a particular *instant* in time rather than a process which extends over a time interval.
2. Write the "Concept Equation" ($E = E'$ in the example).
3. Replace quantities in the "Concept Equation" with more specific representations of the same quantities. Repeat as appropriate.

In the example given, the symbol E representing total mechanical energy in the before picture is replaced with "what it is," namely, the sum of the kinetic energy and the potential energy $K + U$ of the rock in the before picture. On the same line E' has been replaced with what it is, namely, the sum of the kinetic energy and the potential energy $K' + U'$ in the after picture. Quantities that are obviously zero have slashes drawn through them and are omitted from subsequent steps.

This step is repeated in the next line ($mgy = \frac{1}{2}mv'^2$) in which the gravitational potential energy in the before picture, U , has been replaced with what it is, namely mgy , and on the right, the kinetic energy in the after picture has been replaced with what it is, namely, $\frac{1}{2}mv'^2$. The symbol m that appears in this step is defined in the diagram.

4. Solve the problem algebraically. The student is required to solve the problem by algebraically manipulating the symbols rather than substituting values and simultaneously evaluating and manipulating them.

The reasons that physics teachers require students taking college level physics courses to solve the problems algebraically in terms of the symbols rather than working with the numbers are:

- (a) College physics teachers are expected to provide the student with experience in "the next level" in abstract reasoning beyond working with the numbers. To gain this experience, the students must solve the problems algebraically in terms of symbols.
- (b) Students are expected to be able to solve the more general problem in which, whereas certain quantities are to be treated as if they are known, no actual values are given. Solutions to such problems are often used in computer programs which enable the user to obtain results for many different values of the "known quantities." Actual values are

assigned to the known quantities only *after* the user of the program provides them to the program as input—long after the algebraic problem is solved.

- (c) Many problems more complicated than the given example can more easily be solved algebraically in terms of the symbols. Experience has shown that students accustomed to substituting numerical values for symbols at the earliest possible stage in a problem are unable to solve the more complicated problems.

In the example, the algebraic solution begins with the line $mgy = \frac{1}{2}mv'^2$. The m 's appearing on both sides of the equation have been canceled out (this is the algebraic step) in the solution provided. Note that in the example, had the m 's *not* canceled out, a numerical answer to the problem could *not* have been determined since no value for m was given. The next two lines represent the additional steps necessary in solving algebraically for the final speed v' . The final line in the algebraic solution ($v' = \sqrt{2gy}$ in the example) always has the quantity being solved for all by itself on the *left* side of the equation being set equal to an expression involving only known quantities on the right side of the equation. The algebraic solution is not complete if unknown quantities (especially the quantity sought) appear in the expression on the right hand side. Writing the final line of the algebraic solution in the reverse order, e.g. $\sqrt{2gy} = v'$, is unconventional and hence unacceptable. If your algebraic solution naturally leads to that, you should write one more line with the algebraic answer written in the correct order.

- 5) Replace symbols with numerical values with units, $v' = \sqrt{2(9.80 \frac{\text{m}}{\text{s}^2})1.6\text{m}}$ in the example; the units are the units of measurement: $\frac{\text{m}}{\text{s}^2}$ and m in the example).

No computations should be carried out at this stage. Just copy down the algebraic solution but with symbols representing known quantities replaced with numerical values with units. Use parentheses and brackets as necessary for clarity.

- 6) Write the final answer *with units* ($v' = 5.6 \frac{\text{m}}{\text{s}}$ in the example).

Numerical evaluations are to be carried out directly on the calculator and/or on scratch paper. It is unacceptable to clutter the solution with arithmetic and intermediate numerical answers between the previous step and this step. Units should be worked out and provided with the final answer. It *is* good to show some steps in working out the units but for simple cases *units* (not algebraic solutions) may be worked out in your head. In the example provided, it is easy to see that upon taking the square root of the product of $\frac{\text{m}}{\text{s}^2}$ and m, one obtains $\frac{\text{m}}{\text{s}}$ hence no additional steps were depicted.

3 Conservation of Mechanical Energy II: Springs, Rotational Kinetic Energy

A common mistake involving springs is using the length of a stretched spring when the amount of stretch is called for. Given the length of a stretched spring, you have to subtract off the length of that same spring when it is neither stretched nor compressed to get the amount of stretch.

Spring Potential Energy is the potential energy stored in a spring that is compressed or stretched. The spring energy depends on how stiff the spring is and how much it is stretched or compressed. The stiffness of the spring is characterized by the *force constant* of the spring, k . k is also referred to as the *spring constant* for the spring. The stiffer the spring, the bigger its value of k is. The symbol x is typically used to characterize the amount by which a spring is compressed or stretched. It is important to note that x is not the length of the stretched or compressed spring. Instead, it is the difference between the length of the stretched or compressed spring and the length of the spring when it is neither stretched nor compressed. The amount of energy U_s stored in a spring with a force constant (spring constant) k that has either been stretched by an amount x or compressed by an amount x is:

$$U_s = \frac{1}{2} k x^2 \quad (3-1)$$

Rotational Kinetic Energy is the energy that a spinning object has because it is spinning. When an object is spinning, every bit of matter making up the object is moving in a circle (except for those bits on the axis of rotation). Thus, every bit of matter making up the object has some kinetic energy $\frac{1}{2} m v^2$ where the v is the speed of the bit of matter in question and m is its mass. The thing is, in the case of an object that is just spinning, the object itself is not going anywhere, so it has no speed, and the different bits of mass making up the object have different speeds, so there is no one speed v that we can use for the speed of the object in our old expression for kinetic energy $K = \frac{1}{2} m v^2$. The amount of kinetic energy that an object has because it is spinning can be expressed as:

$$K = \frac{1}{2} I \omega^2 \quad (3-2)$$

where the Greek letter omega ω (please don't call it double-u) is used to represent the magnitude of the angular velocity of the object and the symbol I is used to represent the moment of inertia, a.k.a. rotational inertia, of the object. The magnitude of the angular velocity of the object is how fast the object is spinning and the moment of inertia of the object is a measure of the object's natural tendency to spin at a constant rate. The greater the moment of inertia of an object, the harder it is to change how fast that object is spinning.

The magnitude of the angular velocity, the spin rate ω , is measured in units of radians per second where the radian is a unit of angle. An angle is a fraction of a rotation and hence a unit of angle is a fraction of a rotation. If we divide a rotation up into 360 parts then each part is $\frac{1}{360}$ of a rotation and we call each part a degree. In the case of radian measure, we divide the rotation up

into 2π parts and call each part a radian. Thus a radian is $\frac{1}{2\pi}$ of a rotation. The fact that an angle is a fraction of a rotation means that an angle is really a pure number and the word “radian” abbreviated rad, is a reminder about how many parts the rotation has been divided up into, rather than a true unit. In working out the units in cases involving radians, one can simply erase the word radian. This is not the case for actual units such as meters or joules.

The moment of inertia I has units of $\text{kg} \cdot \text{m}^2$. The units of the right hand side of equation 3-2, $K = \frac{1}{2}I \omega^2$, thus work out to be $\text{kg} \cdot \text{m}^2 \frac{\text{rad}^2}{\text{s}^2}$. Taking advantage of the fact that a radian is not a true unit, we can simply erase the units rad^2 leaving us with units of $\text{kg} \cdot \frac{\text{m}^2}{\text{s}^2}$, a combination that we recognize as a joule which it must be since the quantity on the left side of the equation $K = \frac{1}{2}I \omega^2$ (equation 3-2) is an energy.

Energy of Rolling

An object which is rolling is both moving through space and spinning so it has both kinds of kinetic energy, the $\frac{1}{2}mv^2$ and the $\frac{1}{2}I\omega^2$. The movement of an object through space is called translation. To contrast it with rotational kinetic energy, the ordinary kinetic energy $K = \frac{1}{2}mv^2$ is referred to as translational kinetic energy. So, the total kinetic energy of an object that is rolling can be expressed as

$$K_{\text{Rolling}} = K_{\text{Translation}} + K_{\text{Rotation}} \quad (3-3)$$

$$K_{\text{Rolling}} = \frac{1}{2}mv^2 + \frac{1}{2}I\omega^2 \quad (3-4)$$

Now you probably recognize that an object that is rolling without slipping is spinning at a rate that depends on how fast it is going forward. That is to say that the value of ω depends on the value of v . Let’s see how. When an object that is rolling without slipping completes one rotation, it moves a distance equal to its circumference which is 2π times the radius of that part of the object on which the object is rolling.

$$\text{Distance traveled in one rotation} = 2\pi r \quad (3-5)$$

Now if we divide both sides of this equation by the amount of time that it takes for the object to complete one rotation we obtain on the left, the speed of the object and, on the right, we can interpret the 2π as 2π radians and, since 2π radians is one rotation the 2π radians divided by the time it takes for the object to complete one rotation is just the magnitude of the angular velocity ω . Hence we arrive at

$$v = \omega r$$

which is typically written:

$$v = r\omega \quad (3-6)$$

4 Conservation of Momentum

A common mistake involving conservation of momentum crops up in the case of totally inelastic collisions of two objects, the kind of collision in which the two colliding objects stick together and move off as one. The mistake is to use conservation of mechanical energy rather than conservation of momentum. One way to recognize that some mechanical energy is converted to other forms is to imagine a spring to be in between the two colliding objects such that the objects compress the spring. Then imagine that, just when the spring is at maximum compression, the two objects become latched together. The two objects move off together as one as in the case of a typical totally inelastic collision. After the collision, there is energy stored in the compressed spring so it is clear that the total kinetic energy of the latched pair is less than the total kinetic energy of the pair prior to the collision. There is no spring in a typical inelastic collision. The mechanical energy that would be stored in the spring, if there was one, results in permanent deformation and a temperature increase of the objects involved in the collision.

The momentum of an object is a measure of how hard it is to stop that object. The momentum of an object depends on both its mass and its velocity. Consider two objects of the *same mass*, e.g. two baseballs. One of them is coming at you at 10 mph, and the other at 100 mph. Which one has the greater momentum? Answer: The *faster* baseball is, of course, harder to stop, so it has the greater momentum. Now consider two objects of *different mass* with the *same velocity*, e.g. a Ping-Pong ball and a cannon ball, both coming at you at 25 mph. Which one has the greater momentum? The cannon ball is, of course, harder to stop, so it has the greater momentum.

The momentum p of an object is equal to the product¹ of the object's mass m and velocity v :

$$p = mv \quad (4-1)$$

Momentum has direction. Its direction is the same as that of the velocity. In this chapter we will limit ourselves to motion along a line (motion in one dimension). Then there are only two directions, forward and backward. An object moving forward has a positive velocity/momentum and one moving backward has a negative velocity/momentum. In solving physics problems, the decision as to which way is forward is typically left to the problem solver. Once the problem solver decides which direction is the positive direction, she must state what her choice is (this statement, often made by means of notation in a sketch, is an important part of the solution), and stick with it throughout the problem.

The concept of momentum is important in physics because the total momentum of any system remains constant unless there is a net transfer of momentum to that system, and if there is an ongoing momentum transfer, the rate of change of the momentum of the system is equal to the rate at which momentum is being transferred into the system. As in the case of energy, this means that one can make predictions regarding the outcome of physical processes by means of

¹ This classical physics expression is valid for speeds small compared to the speed of light $c = 3.00 \times 10^8$ m/s. The relativistic expression for momentum is $p = mv / \sqrt{1 - v^2/c^2}$. At speeds that are very small compared to the speed of light, the classical physics expression $p = mv$ is a fantastic approximation to the relativistic expression.

simple accounting (bookkeeping) procedures. The case of momentum is complicated by the fact that momentum has direction, but in this initial encounter with the conservation of momentum you will deal with cases involving motion along a straight line. When all the motion is along one and the same line, there are only two possible directions for the momentum and we can use algebraic signs (plus and minus) to distinguish between the two. The principle of Conservation of Momentum applies in general. At this stage in the course however, we will consider only the special case in which there is no net transfer of momentum to (or from) the system from outside the system.

Conservation of Momentum in One Dimension for the Special Case in which there is No Transfer of Momentum to or from the System from Outside the System

In any process involving a system of objects which all move along one and the same line, as long as none of the objects are pushed or pulled along the line by anything outside the system of objects (it's okay if they push and pull on each other), the total momentum before, during, and after the process remains the same.

The total momentum of a system of objects is just the algebraic sum of the momenta of the individual objects. That adjective "algebraic" means you have to pay careful attention to the plus and minus signs. If you define "to the right" as your positive direction and your system of objects consists of two objects, one moving to the right with a momentum of 12 kg·m/s and the other moving to the left with momentum 5 kg·m/s, then the total momentum is (+12 kg·m/s) + (−5 kg·m/s) which is +7 kg·m/s. The plus sign in the final answer means that the total momentum is directed to the right.

Upon reading this selection you'll be expected to be able to apply conservation of momentum to two different kinds of processes. In each of these two classes of processes, the system of objects will consist of only two objects. In one class, called *collisions*, the two objects bump into each other. In the other class, *anti-collisions* the two objects start out together, and spring apart. Some further breakdown of the collisions class is pertinent before we get into examples. The two extreme types of collisions are the *completely inelastic collision*, and the *completely elastic collision*.

Upon a *completely inelastic collision*, the two objects stick together and move off as one. This is the easy case since there is only one final velocity (because they are stuck together, the two objects obviously move off at one and the same velocity). Some mechanical energy is converted to other forms in the case of a completely inelastic collision. It would be a big mistake to apply the principle of conservation of mechanical energy to a completely inelastic collision. *Mechanical energy is not conserved.* The words "completely inelastic" tell you that both objects have the same velocity (as each other) after the collision.

In a *completely elastic collision* (often referred to simply as an *elastic collision*), the objects bounce off each other in such a manner that no mechanical energy is converted into other forms in the collision. Since the two objects move off independently after the collision there are two final velocities. If the masses and the initial velocities are given, conservation of momentum yields one equation with two unknowns—namely, the two final velocities. Such an equation

cannot be solved by itself. In such a case, one must apply the principle of conservation of mechanical energy. It does apply here. The expression "completely elastic" tells you that conservation of mechanical energy does apply.

In applying conservation of momentum one first sketches a before and an after picture in which one defines symbols by labeling objects and arrows (indicating velocity), and defines which direction is chosen as the positive direction. The first line in the solution is always a statement that the total momentum in the before picture is the same as the total momentum in the after picture. This is typically written by means an equation of the form:

$$\sum p_{\rightarrow} = \sum p'_{\rightarrow} \quad (4-2)$$

The Σ in this expression is the upper case Greek letter "sigma" and is to be read "the sum of." Hence the equation reads: "The sum of the momenta to the right in the before picture is equal to the sum of the momenta to the right in the after picture." In doing the sum, a leftward momentum counts as a negative rightward momentum. The arrow subscript is being used to define the positive direction.

Examples

Now let's get down to some examples. We'll use the examples to clarify what is meant by collisions and anti-collisions; to introduce one more concept, namely, relative velocity (sometimes referred to as muzzle velocity); and of course, to show the reader how to apply conservation of momentum.

Example 4-2: A cannon of mass m_C , resting on a frictionless surface, fires a ball of mass m_B . The ball is fired horizontally. The muzzle velocity is v_M . Find the velocity of the ball and the recoil velocity of the cannon.

NOTE: This is an example of an anti-collision problem. It also involves the concept of relative velocity. The muzzle velocity is the relative velocity between the ball and the cannon. It is the velocity at which the two separate. If the velocity of the ball relative to the ground is v'_B to the right, and the velocity of the cannon relative to the ground is v'_C to the left, then the velocity of the ball relative to the cannon, also known as the muzzle velocity of the ball, is $v_M = v'_B + v'_C$. In cases not involving guns or cannons one typically uses the notation v_{rel} for "relative velocity" or, relating to the example at hand, v_{BC} for "velocity of the ball relative to the cannon."

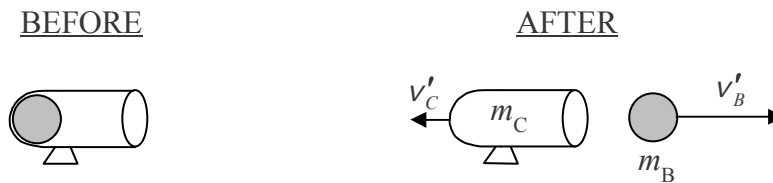

$$\Sigma p_{\rightarrow} = \Sigma p'_{\rightarrow}$$

$$0 = -m_C v'_C + m_B v'_B \quad (1)$$

Also, from the definition of muzzle velocity:

$$v_M = v'_B + v'_C$$

$$v'_C = v_M - v'_B \quad (2)$$

Substituting this result into equation (1) yields:

$$0 = -m_C (v_M - v'_B) + m_B v'_B$$

$$0 = -m_C v_M + m_C v'_B + m_B v'_B$$

$$m_C v'_B + m_B v'_B = m_C v_M$$

$$(m_C + m_B) v'_B = m_C v_M$$

$$v'_B = \frac{m_C}{m_C + m_B} v_M$$

$$v'_C = v_M - \frac{m_C}{m_C + m_B} v_M$$

$$v'_C = \frac{(m_C + m_B)v_M - m_C v_M}{m_C + m_B}$$

$$v'_C = \frac{m_C v_M + m_B v_M - m_C v_M}{m_C + m_B}$$

Now substitute this result into equation (2) above. This yields:

$$v'_C = \frac{m_B}{m_C + m_B} v_M$$

5 Conservation of Angular Momentum

Much as in the case of linear momentum, the mistake that tends to be made in the case of angular momentum is not using the principle of conservation of angular momentum when it should be used, that is, applying conservation of mechanical energy in a case in which mechanical energy is not conserved but angular momentum is. Consider the case, for instance, in which one drops a disk (from a negligible height) that is not spinning, onto a disk that is spinning, and after the drop, the two disks spin together as one. The “together as one” part tips you off that this is a completely inelastic (rotational) collision. Some mechanical energy is converted into thermal energy (and other forms not accounted for) in the collision. It’s easy to see that mechanical energy is converted into thermal energy if the two disks are CD’s and the bottom one is initially spinning quite fast (but is not being driven). When you drop the top one onto the bottom one, there will be quite a bit of slipping before the top disk gets up to speed and the two disks spin as one. During the slipping, it is friction that increases the spin rate of the top CD and slows the bottom one. Friction converts mechanical energy into thermal energy. Hence, the mechanical energy prior to the drop is less than the mechanical energy after the drop.

The angular momentum of an object is a measure of how difficult it is to stop that object from spinning. For an object rotating about a fixed axis, the angular momentum depends on how fast the object is spinning, and on the object's *rotational inertia* (also known as *moment of inertia*) with respect to that axis.

Rotational Inertia (a.k.a. Moment of Inertia)

The rotational inertia of an object with respect to a given rotation axis is a measure of the object's tendency to resist a change in its angular velocity about that axis. The rotational inertia depends on the mass of the object and how that mass is distributed. You have probably noticed that it is easier to start a merry-go-round spinning when it has no children on it. When the kids climb on, the mass of what you are trying to spin is greater, and this means the rotational inertia of the object you are trying to spin is greater. Have you also noticed that if the kids move in toward the center of the merry-go-round it is easier to start it spinning than it is when they all sit on the outer edge of the merry-go-round? It is. The farther, on the average, the mass of an object is distributed away from the axis of rotation, the greater the object's moment of inertia with respect to that axis of rotation. The rotational inertia of an object is represented by the symbol I . During this initial coverage of angular momentum, you will not be required to calculate I from the shape and mass of the object. You will either be given I or expected to calculate it by applying conservation of angular momentum (discussed below).

Angular Velocity

The angular velocity of an object is a measure of how fast it is spinning. It is represented by the Greek letter omega, written ω , (not to be confused with the letter w which, unlike omega, is pointed on the bottom). The most convenient measure of angle in discussing rotational motion is the radian. Like the degree, a radian is a fraction of a revolution. But, while one degree is $\frac{1}{360}$ of a revolution, one radian is $\frac{1}{2\pi}$ of a revolution. The units of angular velocity are then *radians per second* or, in notational form, $\frac{\text{rad}}{\text{s}}$. Angular velocity has direction or sense of rotation

associated with it. If one defines a rotation which is clockwise when viewed from above as a positive rotation, then an object which is rotating counterclockwise as viewed from above is said to have a negative angular velocity. In any problem involving angular velocity, one is free to choose the positive sense of rotation, but then one must stick with that choice throughout the problem.

Angular Momentum

The angular momentum L of an object is given by:

$$L = I\omega \quad (5-1)$$

Note that this is consistent with our original definition of angular momentum as a measure of the degree of the object's tendency to keep on spinning, once it is spinning. The greater the rotational inertia of the object, the more difficult it is to stop the object from spinning, and the greater the angular velocity of the object, the more difficult it is to stop the object from spinning.

The direction of angular momentum is the same as the direction of the corresponding angular velocity.

Torque

We define torque by analogy with force which is an ongoing push or pull on an object. When there is a single force acting on a particle, the momentum of that particle is changing. A torque is what you are exerting on the lid of a jar when you are trying to remove the lid. When there is a single torque acting on a rigid object, the angular momentum of that object is changing.

Conservation of Angular Momentum

Angular Momentum is an important concept because, if there is no angular momentum transferred to or from a system, the total angular momentum of that system does not change, and if there is angular momentum being transferred to a system, the rate of change of the angular momentum of the system is equal to the rate at which angular momentum is being transferred to the system. As in the case of energy and momentum, this means we can use simple accounting (bookkeeping) procedures for making predictions on the outcomes of physical processes. In this chapter we focus on the special case in which there are no external torques which means that no angular momentum is transferred to or from the system.

Conservation of Angular Momentum for the Special Case in which no Angular Momentum is Transferred to or from the System from Outside the System

In any physical process involving an object or a system of objects free to rotate about an axis, as long as there are no external torques exerted on the system of objects, the total angular momentum of that system of objects remains the same throughout the process.

Examples

The application of the conservation of angular momentum in solving physics problems for cases involving no transfer of angular momentum to or from the system from outside the system (no external torque) is very similar to the application of the conservation of energy and to the application of the conservation of momentum. One selects two instants in time, defines the earlier one as the before instant and the later one as the after instant, and makes corresponding sketches of the object or objects in the system. Then one writes

$$L = L' \quad (5-2)$$

meaning "the angular momentum in the before picture equals the angular momentum in the after picture." Next, one replaces each L with what it is in terms of the moments of inertia and angular velocities in the problem and solves the resulting algebraic equation for whatever is sought.

Example 5-1

A skater is spinning at 32.0 rad/s with her arms and legs extended outward. In this position her moment of inertia with respect to the vertical axis about which she is spinning is $45.6 \text{ kg} \cdot \text{m}^2$. She pulls her arms and legs in close to her body changing her moment of inertia to $17.5 \text{ kg} \cdot \text{m}^2$. What is her new angular velocity?

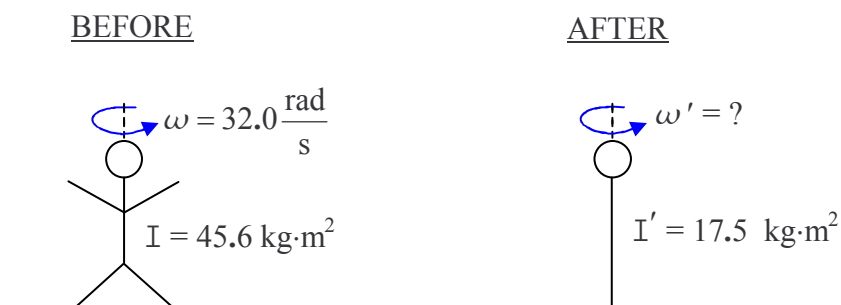

$$L_{\mathbf{G}} = L'_{\mathbf{G}}$$

$$I \omega = I' \omega'$$

$$\omega' = \frac{I}{I'} \omega$$

$$\omega' = \frac{45.6 \text{ kg} \cdot \text{m}^2}{17.5 \text{ kg} \cdot \text{m}^2} 32.0 \text{ rad/s}$$

$$\omega' = 83.4 \frac{\text{rad}}{\text{s}}$$

Example 5-2

A horizontal disk of rotational inertia $4.25 \text{ kg} \cdot \text{m}^2$ with respect to its axis of symmetry is spinning counterclockwise about its axis of symmetry, as viewed from above, at 15.5 revolutions per second on a frictionless massless bearing. A second disk, of rotational inertia $1.80 \text{ kg} \cdot \text{m}^2$ with respect to its axis of symmetry, spinning *clockwise* as viewed from above about the same axis (which is also its axis of symmetry) at 14.2 revolutions per second, is dropped on top of the first disk. The two disks stick together and rotate as one about their common axis of symmetry at what new angular velocity (in units of radians per second)?

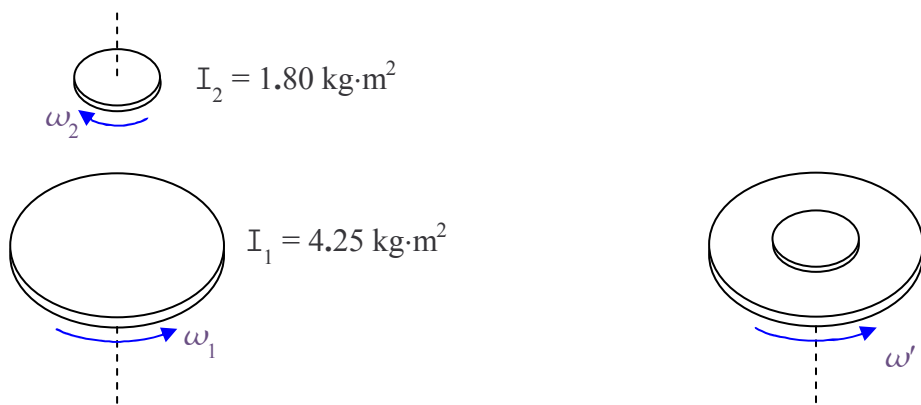

Some preliminary work (expressing the given angular velocities in units of rad/s):

$$\omega_1 = 15.5 \frac{\text{rev}}{\text{s}} \left(\frac{2\pi \text{ rad}}{\text{rev}} \right) = 97.39 \frac{\text{rad}}{\text{s}}$$

$$\omega_2 = 14.2 \frac{\text{rev}}{\text{s}} \left(\frac{2\pi \text{ rad}}{\text{rev}} \right) = 89.22 \frac{\text{rad}}{\text{s}}$$

Now we apply the principle of conservation of angular momentum for the special case in which there is no transfer of angular momentum to or from the system from outside the system. Referring to the diagram:

$$L_G = L'_G$$

We define counterclockwise, as viewed from above, to be the “+” sense of rotation.

$$I_1 \omega_1 - I_2 \omega_2 = (I_1 + I_2) \omega'$$

$$\omega' = \frac{I_1 \omega_1 - I_2 \omega_2}{I_1 + I_2}$$

$$\omega' = \frac{(4.25 \text{ kg} \cdot \text{m}^2) 97.39 \text{ rad/s} - (1.80 \text{ kg} \cdot \text{m}^2) 89.22 \text{ rad/s}}{4.25 \text{ kg} \cdot \text{m}^2 + 1.80 \text{ kg} \cdot \text{m}^2}$$

$$\omega' = 41.9 \frac{\text{rad}}{\text{s}} \quad (\text{Counterclockwise as viewed from above.})$$

6 One-Dimensional Motion (Motion Along a Line): Definitions and Mathematics

A mistake that is often made in linear motion problems involving acceleration, is using the velocity at the end of a time interval as if it was valid for the entire time interval. The mistake crops up in constant acceleration problems when folks try to use the definition of average velocity $\bar{v} = \frac{\Delta x}{\Delta t}$ in the solution. Unless you are asked specifically about average velocity, you will never need to use this equation to solve a physics problem. Avoid using this equation—it will only get you into trouble. For constant acceleration problems, use the set of constant acceleration equations provided you.

Here we consider the motion of a particle along a straight line. The particle can speed up and slow down and it can move forward or backward but it does not leave the line. While the discussion is about a particle (a fictitious object which at any instant in time is at a point in space but has no extent in space—no width, height, length, or diameter) it also applies to a rigid body that moves along a straight line path without rotating, because in such a case, every particle of the body undergoes one and the same motion. This means that we can pick one particle on the body and when we have determined the motion of that particle, we have determined the motion of the entire rigid body.

So how do we characterize the motion of a particle? Let's start by defining some variables:

- t How much time t has elapsed since some initial time. The initial time is often referred to as “the start of observations” and even more often assigned the value 0. We will refer to the amount of time t that has elapsed since time zero as the stopwatch reading. A time interval Δt (to be read “delta t”) can then be referred to as the difference between two stopwatch readings.
- x Where the object is along the straight line. To specify the position of an object on a line, one has to define a reference position (the start line) and a forward direction. Having defined a forward direction, the backward direction is understood to be the opposite direction. It is conventional to use the symbol x to represent the position of a particle. The values that x can have, have units of length. The SI unit of length is the meter. (SI stands for “Système International,” the international system of units.) The symbol for the meter is m. The physical quantity x can be positive or negative where it is understood that a particle which is said to be minus five meters forward of the start line (more concisely stated as $x = -5$ m) is actually five meters behind the start line.

- v How fast and which way the particle is going—the velocity¹ of the object. Because we are considering an object that is moving only along a line, the “which way” part is either forward or backward. Since there are only two choices, we can use an algebraic sign (“+” or “−”) to characterize the direction of the velocity. By convention, a positive value of velocity is used for an object that is moving forward, and a negative value is used for an object that is moving backward. Velocity has both magnitude and direction. The magnitude of a physical quantity that has direction is how big that quantity is, regardless of its direction. So the magnitude of the velocity of an object is how fast that object is going, regardless of which way it is going. Consider an object that has a velocity of 5 m/s. The magnitude of the velocity of that object is 5 m/s. Now consider an object that has a velocity of −5 m/s. (It is going backward at 5 m/s.) The magnitude of its velocity is also 5 m/s. Another name for the magnitude of the velocity is the speed. In both of the cases just considered, the speed of the object is 5 m/s despite the fact that in one case the velocity was −5 m/s. To understand the “how fast” part, just imagine that the object whose motion is under study has a built-in speedometer. The magnitude of the velocity, a.k.a. the speed of the object, is simply the speedometer reading.
- a Next we have the question of how fast and which way the velocity of the object is changing. We call this the acceleration of the object. Instrumentally, the acceleration of a car is indicated by how fast and which way the tip of the speedometer needle is moving. In a car, it is determined by how far down the gas pedal is pressed or, in the case of a car that is slowing down, how hard the driver is pressing on the brake pedal. In the case of an object that is moving along a straight line, if the object has some acceleration, then the speed of the object is changing.

¹ Looking ahead: The velocity of an object in the one-dimensional world of this chapter is, in the three-dimensional world in which we live, the x component of the velocity of the object. For the case of an object whose velocity has only an x component, to get the velocity of the object through three dimensional space, you just have to multiply the x component of the velocity by the unit vector \hat{x} . In vector notation, saying that an object has a velocity of $5\text{m/s}\hat{x}$ means the object is moving with a speed of 5m/s in the +x direction and saying that an object has a velocity of $-5\text{m/s}\hat{x}$ means the object is moving with a speed of 5m/s in the −x direction.

Okay, we've got the quantities used to characterize motion. Soon, we're going to develop some useful relations between those variables. While we're doing that, I want you to keep these four things in mind:

1. We're talking about an object moving along a line.
2. Being in motion means having your position change with time.
3. You already have an intuitive understanding of what instantaneous velocity is because you have ridden in a car. You know the difference between going 65 mph and 15 mph and you know very well that you neither have to go 65 miles nor travel for an hour to be going 65 mph. In fact, it is entirely possible for you to have a speed of 65 mph for just an instant (no time interval at all)—it's how fast you are going (what your speedometer reading is) at that instant. To be sure, the speedometer needle may be just "swinging through" that reading, perhaps because you are in the process of speeding up to 75 mph from some speed below 65 mph, but the 65 mph speed still has meaning and still applies to that instant when the speedometer reading is 65 mph. Take this speed concept with which you are so familiar, tack on some directional information, which for motion on a line just means, specify "forward" or "backward; and you have what is known as the instantaneous velocity of the object whose motion is under consideration.

A lot of people say that the speed of an object is how far that object travels in a certain amount of time. No! That's a distance. Speed is a rate. Speed is never how far, it is how fast. So if you want to relate it to a distance you might say something like, "Speed is what you multiply by a certain amount of time to determine how far an object would go in that amount of time if the speed stayed the same for that entire amount of time." For instance, for a car with a speed of 25 mph, you could say that 25 mph is what you multiply by an hour to determine how far that car would go in an hour if it maintained a constant speed of 25 mph for the entire hour. But why explain it in terms of position? It is a rate. It is how fast the position of the object is changing. If you are standing on a street corner and a car passes you going 35 mph, I bet that if I asked you to estimate the speed of the car that you would get it right within 5 mph one way or the other. But if we were looking over a landscape on a day with unlimited visibility and I asked you to judge the distance to a mountain that was 35 miles away just by looking at it, I think the odds would be very much against you getting it right to within 5 miles. In a case like that, you have a better feel for "how fast" than you do for "how far." So why define speed in terms of distance when you can just say that the speed of an object is how fast it is going?

4. You already have an intuitive understanding of what acceleration is. You have been in a car when it was speeding up. You know what it feels like to speed up gradually (small acceleration) and you know what it feels like to speed up rapidly (big, "pedal-to-the-metal," acceleration).

All right, here comes the analysis. We have a start line ($x=0$) and a positive direction (meaning the other way is the negative direction).

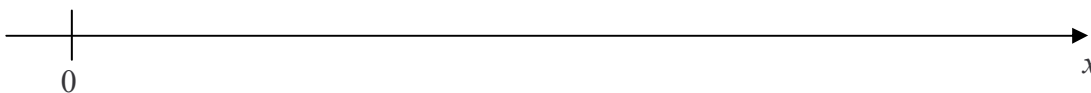

Consider a moving particle that is at position x_1 when the clock reads t_1 and at position x_2 when the clock reads t_2 .

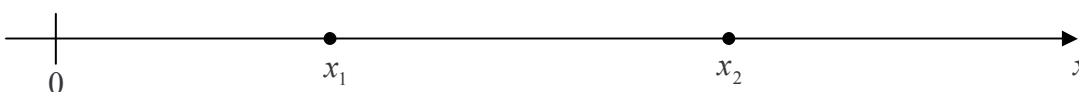

The displacement of the particle is, by definition, the change in position $\Delta x = x_2 - x_1$ of the particle. The average velocity \bar{v} is, by definition,

$$\bar{v} = \frac{\Delta x}{\Delta t} \quad (6-1)$$

where $\Delta t = t_2 - t_1$ is the change in clock reading. Now the average velocity is not something that one would expect you to have an intuitive understanding for, as you do in the case of instantaneous velocity. The average velocity is not something that you can read off the speedometer, and frankly, it's typically not as interesting as the actual (instantaneous) velocity, but it is easy to calculate and we can assign a meaning to it (albeit a hypothetical meaning). It is the constant velocity at which the particle would have to travel if it was to undergo the same displacement $\Delta x = x_2 - x_1$ in the same time $\Delta t = t_2 - t_1$ at *constant* velocity. The importance of the average velocity in this discussion lies in the fact that it facilitates the calculation of the instantaneous velocity.

Calculating the instantaneous velocity in the case of a constant velocity is easy. Looking at what we mean by average velocity, it is obvious that if the velocity isn't changing, the instantaneous velocity is the average velocity. So, in the case of a constant velocity, to calculate the instantaneous velocity, all we have to do is calculate the average velocity, using any displacement with its corresponding time interval, that we want. Suppose we have position vs. time data on, for instance, a car traveling a straight path at 24 m/s.

Here's some idealized fictitious data for just such a case.

Data Reading Number	Time [seconds]	Position [meters]
0	0	0
1	0.100	2.30
2	1.00	23.0
3	10.0	230
4	100.0	2300

Remember, the speedometer of the car is always reading 24 m/s. (It should be clear that the car was already moving as it crossed the start line at time zero—think of time zero as the instant a stopwatch was started and the times in the table as stopwatch readings.) The position is the distance forward of the start line.

Note that for this special case of constant velocity, you get the same average velocity, the known value of constant speed, no matter what time interval you choose. For instance, if you choose the time interval from 1.00 seconds to 10.0 seconds:

$$\bar{v} = \frac{\Delta x}{\Delta t} \quad \text{(Average velocity.)}$$

$$\bar{v} = \frac{x_3 - x_2}{t_3 - t_2}$$

$$\bar{v} = \frac{230 \text{ m} - 23.0 \text{ m}}{10.0 \text{ s} - 1.00 \text{ s}}$$

$$\bar{v} = 23.0 \frac{\text{m}}{\text{s}}$$

and if you choose the time interval 0.100 seconds to 100.0 seconds:

$$\bar{v} = \frac{\Delta x}{\Delta t}$$

$$\bar{v} = \frac{x_4 - x_1}{t_4 - t_1}$$

$$\bar{v} = \frac{2300 \text{ m} - 2.30 \text{ m}}{100.0 \text{ s} - 0.100 \text{ s}}$$

$$\bar{v} = 23.0 \frac{\text{m}}{\text{s}}$$

The points that need emphasizing here are that, if the velocity is constant then the calculation of the average speed yields the instantaneous speed (the speedometer reading, the speed we have an intuitive feel for), and when the velocity is constant, it doesn't matter what time interval you use to calculate the average velocity; in particular, a small time interval works just as well as a big time interval.

So how do we calculate the instantaneous velocity of an object at some instant when the instantaneous velocity is continually changing? Let's consider a case in which the *velocity is continually increasing*. Here we show some idealized fictitious data (consistent with the way an object really moves) for just such a case.

Data Reading Number	Time since object was at start line. [s]	Position (distance ahead of start line) [m]	Velocity (This is what we are trying to calculate. Here are the correct answers.) [m/s]
0	0	0	10
1	1	14	18
2	1.01	14.1804	18.08
3	1.1	15.84	18.8
4	2	36	26
5	5	150	50

What I want to do with this fictitious data is to calculate an average velocity during a time interval that begins with $t = 1$ s and compare the result with the actual velocity at time $t = 1$ s. The plan is to do this repeatedly, with each time interval used being smaller than the previous one.

Average velocity from $t = 1$ s to $t = 5$ s:

$$\bar{v} = \frac{\Delta x}{\Delta t}$$

$$\bar{v} = \frac{x_5 - x_1}{t_5 - t_1}$$

$$\bar{v} = \frac{150 \text{ m} - 14 \text{ m}}{5 \text{ s} - 1 \text{ s}}$$

$$\bar{v} = 34 \frac{\text{m}}{\text{s}}$$

Note that this value is quite a bit larger than the correct value of the instantaneous velocity at $t = 1$ s (namely 18 m/s). It does fall between the instantaneous velocity of 18 m/s at $t = 1$ s and the instantaneous velocity of 50 m/s at $t = 5$ seconds. That makes sense since, during the time interval, the velocity takes on various values which for $1 \text{ s} < t < 5 \text{ s}$ are all greater than 18 m/s but less than 50 m/s.

For the next two time intervals in decreasing time interval order (calculations not shown):

Average velocity from $t = 1$ to $t = 2$ s: 22 m/s

Average velocity from $t = 1$ to $t = 1.1$ s: 18.4 m/s

And for the last time interval, we do show the calculation:

$$\bar{v} = \frac{\Delta x}{\Delta t}$$

$$\bar{v} = \frac{x_2 - x_1}{t_2 - t_1}$$

$$\bar{v} = \frac{14.1804 \text{ m} - 14 \text{ m}}{1.01 \text{ s} - 1 \text{ s}}$$

$$\bar{v} = 18.04 \frac{\text{m}}{\text{s}}$$

Here I copy all the results so that you can see the trend:

Average velocity from $t = 1$ to $t = 5$ s: 34 m/s

Average velocity from $t = 1$ to $t = 2$ s: 22 m/s

Average velocity from $t = 1$ to $t = 1.1$ s: 18.4 m/s

Average velocity from $t = 1$ to $t = 1.01$ s: 18.04 m/s

Every answer is bigger than the instantaneous velocity at $t = 1$ s (namely 18 m/s). Why? Because the distance traveled in the time interval under consideration is greater than it would have been if the object moved with a constant velocity of 18 m/s. Why? Because the object is speeding up, so, for most of the time interval the object is moving faster than 18 m/s, so, the average value during the time interval must be greater than 18 m/s. But notice that as the time interval (that starts at $t = 1$ s) gets smaller and smaller, the average velocity over the time interval gets closer and closer to the actual instantaneous velocity at $t = 1$ s. By induction, we conclude that if we were to use even smaller time intervals, as the time interval we chose to use was made smaller and smaller, the average velocity over that tiny time interval would get closer and closer to the instantaneous velocity, so that when the time interval got to be so small as to be virtually indistinguishable from zero, the value of the average velocity would get to be indistinguishable from the value of the instantaneous velocity. We write that:

$$v = \lim_{\Delta t \rightarrow 0} \frac{\Delta x}{\Delta t}$$

(Note the absence of the bar over the v . This v is the instantaneous velocity.) This expression for v is, by definition, the derivative of x with respect to t . The derivative of x with respect to t is written as $\frac{dx}{dt}$ which means that

$$v = \frac{dx}{dt} \quad (6-2)$$

Note that, as mentioned, $\frac{dx}{dt}$ is the derivative of x with respect to t . It is not some variable d times x all divided by d times t . It is to be read “dee ex by dee tee” or, better yet, “the derivative of x with respect to t .” Conceptually what it means is, starting at that value of time t at which you wish to find the velocity, let t change by a very small amount. Find the (also very small) amount by which x changes as a result of the change in t and divide the tiny change in x by the tiny change in t . Fortunately, given a function that provides the position x for any time t , we don’t have to go through all of that to get v , because the branch of mathematics known as differential calculus gives us a much easier way of determining the derivative of a function that can be expressed in equation form. A function, in this context, is an equation involving two variables, one of which is completely alone on the left side of the equation, the other of which, is in a mathematical expression on the right. The variable on the left is said to be a function of the variable on the right. Since we are currently dealing with how the position of a particle depends on time, we use x and t as the variables in the functions discussed in the remainder of this chapter. In the example of a function that follows, we use the symbols x_0 , v_0 , and a to represent constants:

$$x = x_0 + v_0 t + \frac{1}{2} at^2 \quad (6-3)$$

The symbol t represents the reading of a running stopwatch. That reading changes so t is a variable. For each different value of t , we have a different value of x , so x is also a variable. Some folks think that any symbol whose value is not specified is a variable. Not so. If you know that the value of a symbol is fixed, then that symbol is a constant. You don’t have to know the value of the symbol for it to be a constant; you just have to know that it is fixed. This is the case for x_0 , v_0 , and a in equation 6-3 above.

Acceleration

At this point you know how to calculate the rate of change of something. Let’s apply that knowledge to acceleration. Acceleration is the rate of change of velocity. If you are speeding up, then your acceleration is how fast you are speeding up. To get an average value of acceleration over a time interval Δt , we determine how much the velocity changes during that time interval and divide the change in velocity by the change in stopwatch reading. Calling the velocity change Δv , we have

$$\bar{a} = \frac{\Delta v}{\Delta t} \quad (6-4)$$

To get the acceleration at a particular time t we start the time interval at that time t and make it an infinitesimal time interval. That is:

$$a = \lim_{\Delta t \rightarrow 0} \frac{\Delta v}{\Delta t}$$

The right side is, of course, just the derivative of v with respect to t :

$$a = \frac{dv}{dt} \tag{6-5}$$

7 One-Dimensional Motion: The Constant Acceleration Equations

The constant acceleration equations presented in this chapter are only applicable to situations in which the acceleration is constant. The most common mistake involving the constant acceleration equations is using them when the acceleration is changing.

In chapter 6 we established that, by definition,

$$a = \frac{dv}{dt}$$

(which we called equation 6-5) where a is the acceleration of an object moving along a straight line path, v is the velocity of the object and t , which stands for time, represents the reading of a stopwatch.

This equation is called a differential equation because that is the name that we give to equations involving derivatives. It's true for any function that gives a value of a for each value of t . An important special case is the case in which a is simply a constant. Here we derive some relations between the variables of motion for just that special case, the case in which a is constant.

Equation 6-5, $a = \frac{dv}{dt}$, with a stipulated to be a constant, can be considered to be a relationship between v and t . Solving it is equivalent to finding an expression for the function that gives the value of v for each value of t . So our goal is to find the function whose derivative $\frac{dv}{dt}$ is a constant. The derivative, with respect to t , of a constant times t is just the constant. Recalling that we want that constant to be a , let's try:

$$v = at$$

We'll call this our trial solution. Let's plug it into equation 6-5, $a = \frac{dv}{dt}$, and see if it works.

Equation 6-5 can be written:

$$a = \frac{d}{dt}v$$

and when we plug our trial solution $v = at$ into it we get:

$$a = \frac{d}{dt}(at)$$

$$a = a \frac{d}{dt}t$$

$$a = a \cdot 1$$

$$a = a$$

That is, our trial solution $v = at$ leads to an identity. Thus, our trial solution is indeed a solution to the equation $a = \frac{dv}{dt}$. Let's see how this solution fits in with the linear motion situation under study.

In that situation, we have an object moving along a straight line and we have defined a one-dimensional coordinate system which can be depicted as

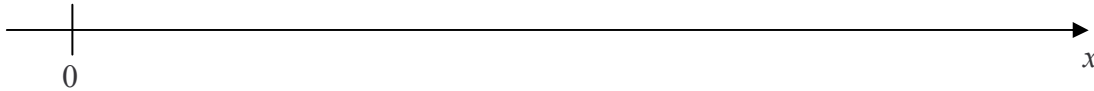

and consists of nothing more than an origin and a positive direction for the position variable x . We imagine that someone starts a stopwatch at a time that we define to be “time zero,” $t = 0$, a time that we also refer to as “the start of observations.” Rather than limit ourselves to the special case of an object that is at rest at the origin at time zero, we assume that it could be moving with any velocity and be at any position on the line at time zero and define the constant x_0 to be the position of the object at time zero and the constant v_0 to be the velocity of the object at time zero.

Now the solution $v = at$ to the differential equation $a = \frac{dv}{dt}$ yields the value $v = 0$ when $t = 0$

(just plug $t = 0$ into $v = at$ to see this). So, while $v = at$ does solve $a = \frac{dv}{dt}$, it does not meet the conditions at time zero, namely that $v = v_0$ at time zero. We can fix the initial condition problem easily enough by simply adding v_0 to the original solution yielding

$$v = v_0 + at \quad (7-1)$$

This certainly makes it so that v evaluates to v_0 when $t = 0$. But is it still a solution to $a = \frac{dv}{dt}$?

Let's try it. If $v = v_0 + at$, then

$$a = \frac{dv}{dt} = \frac{d}{dt}(v_0 + at) = \frac{d}{dt}v_0 + \frac{d}{dt}(at) = 0 + a \frac{d}{dt}t = a .$$

$v = v_0 + at$, when substituted into $a = \frac{dv}{dt}$ leads to an identity so $v = v_0 + at$ is a solution to

$a = \frac{dv}{dt}$. What we have done is to take advantage of the fact that the derivative of a constant is zero, so if you add a constant to a function, you do not change the derivative of that function.

The solution $v = v_0 + at$ is not only a solution to the equation $a = \frac{dv}{dt}$ (with a stipulated to be a constant) but it is a solution to the whole problem since it also meets the initial value condition that $v = v_0$ at time zero. The solution, equation 7-1:

$$v = v_0 + at$$

is the first of a set of four constant acceleration equations to be developed in this chapter.

The other definition provided in the last section was equation 6-2:

$$v = \frac{dx}{dt}$$

which in words can be read as: The velocity of an object is the rate of change of the position of the object (since the derivative of the position with respect to time is the rate of change of the position). Substituting our recently-found expression for velocity yields

$$v_0 + at = \frac{dx}{dt}$$

which can be written as:

$$\frac{dx}{dt} = v_0 + at \quad (7-2)$$

We seek a function that gives a value of x for every value of t , whose derivative $\frac{dx}{dt}$ is the sum of terms $v_0 + at$. Given the fact that the derivative of a sum will yield a sum of terms, namely the sum of the derivatives, let's try a function represented by the expression $x = x_1 + x_2$. This works if $\frac{dx_1}{dt}$ is v_0 and $\frac{dx_2}{dt}$ is at . Let's focus on x_1 first. Recall that v_0 is a constant. Further recall that the derivative-with-respect-to- t of a constant times t , yields that constant. So check out $x_1 = v_0 t$. Sure enough, the derivative of $v_0 t$ with respect to t is v_0 , the first term in equation 7-2 above. So far we have

$$x = v_0 t + x_2 \quad (7-3)$$

Now let's work on x_2 . We need $\frac{dx_2}{dt}$ to be at . Knowing that when we take the derivative of something with t^2 in it we get something with t in it we try $x_2 = \text{constant} \cdot t^2$. The derivative of that is $2 \cdot \text{constant} \cdot t$ which is equal to at if we choose $\frac{1}{2}a$ for the constant. If the constant is $\frac{1}{2}a$ then our trial solution for x_2 is $x_2 = \frac{1}{2}at^2$. Plugging this in for x_2 in equation 7-3, $x = v_0 t + x_2$, yields:

$$x = v_0 t + \frac{1}{2}at^2$$

Now we are in a situation similar to the one we were in with our first expression for $v(t)$. This expression for x *does* solve

$$\frac{dx}{dt} = v_0 + at \quad (7-4)$$

but it does *not* give x_0 when you plug 0 in for t . Again, we take advantage of the fact that you can add a constant to a function without changing the derivative of that function. This time we add the constant x_0 so

$$x = x_0 + v_0 t + \frac{1}{2} at^2 \quad (7-5)$$

This meets both our criteria: It solves equation 7-4, $\frac{dx}{dt} = v_0 + at$, and it evaluates to x_0 when $t = 0$. We have arrived at the second equation in our set of four constant acceleration equations.

The two that we have so far are, equation 7-5:

$$x = x_0 + v_0 t + \frac{1}{2} at^2$$

and equation 7-1:

$$v = v_0 + at$$

These two are enough, but to simplify the solution of constant acceleration problems, we use algebra to come up with two more constant acceleration equations. Solving equation 7-1,

$v = v_0 + at$, for a yields $a = \frac{v - v_0}{t}$ and if you substitute that into equation 7-5 you quickly arrive at the third constant acceleration equation

$$x = x_0 + \frac{v_0 + v}{2} t \quad (7-6)$$

Solving equation 7-1, $v = v_0 + at$, for t yields $t = \frac{v - v_0}{a}$ and if you substitute that into equation 7-5 you quickly arrive at the final constant acceleration equation:

$$v^2 = v_0^2 + 2a(x - x_0) \quad (7-7)$$

For your convenience, we copy down the entire set of constant acceleration equations that you are expected to use in your solutions to problems involving constant acceleration:

$$x = x_0 + v_0 t + \frac{1}{2} at^2$$

$$x = x_0 + \frac{v_0 + v}{2} t$$

$$v = v_0 + at$$

$$v^2 = v_0^2 + 2a(x - x_0)$$

(Constant
Acceleration
Equations)

8 One-Dimensional Motion: Collision Type II

A common mistake one often sees in incorrect solutions to collision type two problems is using a different coordinate system for each of the two objects. It is tempting to use the position of object 1 at time 0 as the origin for the coordinate system for object 1 and the position of object 2 at time 0 as the origin for the coordinate system for object 2. This is a mistake. One should choose a single origin and use it for both particles. (One should also choose a single positive direction.)

We define a **Collision Type II problem**¹ to be one in which two objects are moving along one and the same straight line and the questions are, “When and where are the two objects at one and the same position?” In *some* problems in this class of problems, the word “collision” can be taken literally, but the objects don’t have to actually crash into each other for the problem to fall into the “Collision Type II” category. Furthermore, the restriction that both objects travel along one and the same line can be relaxed to cover for instance, a case in which two cars are traveling in adjacent lanes of a straight flat highway. The easiest way to make it clear what we mean here is to give you an example of a Collision Type II problem.

Example 8-1: A Collision Type II Problem

A car traveling along a straight flat highway is moving along at 41.0 m/s when it passes a police car standing on the side of the highway. 3.00 s after the speeder passes it, the police car begins to accelerate at a steady 5.00 m/s². The speeder continues to travel at a steady 41.0 m/s. (a) How long does it take for the police car to catch up with the speeder? (b) How far does the police car have to travel to catch up with the speeder? (c) How fast is the police car going when it catches up with the speeder?

We are going to use this example to illustrate how, in general, one solves a “Collision Type II Problem.”

The first step in any “Collision Type II” problem is to establish one and the same coordinate system for both objects. Since we are talking about one-dimensional motion, the coordinate system is just a single axis, so what we are really saying is that we have to establish a start line (the zero value for the position variable x) and a positive direction, and we have to use the same start line and positive direction for both objects.

A convenient start line in the case at hand is the initial position of the police car. Since both cars go in the same direction, the obvious choice for the positive direction is the direction in which both cars go.

¹ We didn’t name it that at the time since it was the only collision problem you were faced with then, but we define the “Collision Type I Problem” to be the kind you solved in your study of momentum, the kind of problem (and variations on same) in which two objects collide, and given the initial velocity and the mass of each object, you are supposed to find the final velocity of each object.

Next, we establish one and the same time variable t for both objects. More specifically, we establish what we mean by time zero, a time zero that applies to both objects. To choose time zero wisely, we actually have to think ahead to the next step in the problem, a step in which we use the constant acceleration equations to write an expression for the position of each object in terms of the time t . We want to choose a time zero, $t = 0$, such that for all positive values of t , that is for all future times, the acceleration of each object is indeed constant. In the case at hand, the first choice that suggests itself to me is the instant at which the speeder first passes the police car. But if we “start the stopwatch” at that instant, we find that as time passes, the acceleration of the police car is not constant; rather, the police car has an acceleration of zero for three seconds and then, from then on, it has an acceleration of 5.00 m/s^2 . So we wouldn’t be able to use a single constant acceleration equation to write down an expression for the position of the police car that would be valid for all times $t \geq 0$. Now the next instant that suggests itself to me as a candidate for time zero is the instant at which the police car starts accelerating. This turns out to be the right choice. From that instant on, both cars have constant acceleration (which is 0 in the case of the speeder and 5.00 m/s^2 in the case of the police car). Furthermore, we have information on the conditions at that instant. For instance, based on our start line, we know that the position of the police car is zero, the velocity of the police car is zero, and the acceleration of the police car is 5.00 m/s^2 at that instant. These become our “initial values” when we choose time zero to be the instant at which the police car starts accelerating. The one thing we don’t know at that instant is the position of the speeder. But we do have enough information to determine the position of the speeder at the instant that we choose to call time zero. Our choice of time zero actually causes the given problem to break up into two problems: (1) Find the position of the speeder at time 0, and (2) Solve the “Collision Type II” problem.

The solution of the preliminary problem, finding the position of the speeder at time 0, is quite easy in this case because the speed of the speeder is constant. Thus the distance traveled is just the speed times the time.

$$d = v_s t'$$

$$d = \left(41.0 \frac{\text{m}}{\text{s}} \right) (3.00 \text{ s})$$

$$d = 123 \text{ m}$$

I used the symbol t' here to distinguish this time from the time t that we will use in the “Collision Type II” part of the problem. We can think of the problem as one that requires two stopwatches: One stopwatch, we start at the instant the speeder passes the police car. This one is used for the preliminary problem and we use the symbol t' to represent the value of its reading. The second one is used for the “Collision Type II” problem. It is started at the instant the police car starts accelerating and we will use the symbol t to represent the value of its reading. Note that $d = 123 \text{ m}$ is the position of the speeder, relative to our established start line, at $t = 0$.

Now we are in a position to solve the “Collision Type II” problem. We begin by making a sketch of the situation. The sketch is a critical part of our solution. Sketches are used to define

constants and variables. The required sketch for a “Collision Type II” problem is one that depicts the initial conditions.

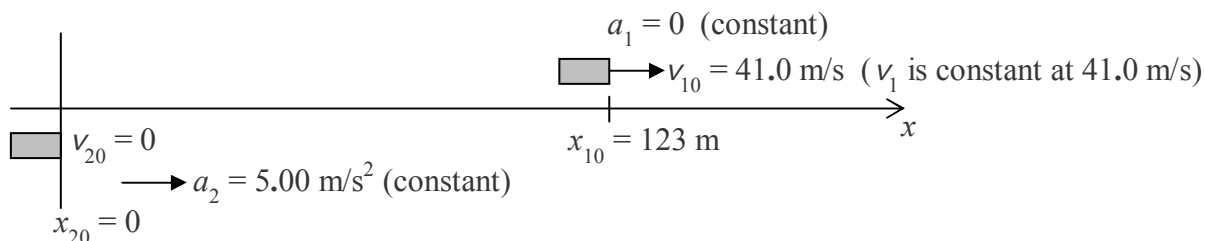

We have defined the speeder’s car to be car 1 and the police car to be car 2. From the constant acceleration equation (the one that gives the position of an object as a function of time) we have for the speeder:

$$x_1 = x_{10} + v_{10}t + \frac{1}{2}a_1t^2$$

$$x_1 = x_{10} + v_{10}t \quad (8-1)$$

where we have incorporated the fact that a_1 is zero. For the police car:

$$x_2 = x_{20} + v_{20}t + \frac{1}{2}a_2t^2$$

$$x_2 = \frac{1}{2}a_2t^2 \quad (8-2)$$

where we have incorporated the fact that $x_{20} = 0$ and the fact that $v_{20} = 0$. Note that both equations (8-1 and 8-2) have the same time variable t . The expression for x_1 (equation 8-1), gives the position of the speeder’s car for any time t . You tell me the time t , and I can tell you where the speeder’s car is at that time t just by plugging it into equation 8-1. Similarly, equation 8-2 for x_2 gives the position of the police car for any time t . Now there is one special time t , let’s call it t^* when both cars are at the same position. The essential part of solving a “Collision Type II” problem is finding that that special time t^* which we refer to as the “collision time.” Okay, now here comes the big central point for the “Collision Type II” problem. At the special time t^* ,

$$x_1 = x_2 \quad (8-3)$$

This small simple equation is the key to solving every “Collision Type II” problem. Substituting our expressions for x_1 and x_2 in equations 1 and 2 above, and designating the time as the collision time t^* we have

$$x_{10} + v_{10}t^* = \frac{1}{2}a_2t^{*2}$$

This yields a single equation in a single unknown, namely, the collision time t^* . We note that t^* appears to the second power. This means that the equation is a quadratic equation so we will probably (and in this case it turns out that we do) need the quadratic formula to solve it. Thus,

we need to rearrange the terms as necessary to get the equation in the form of the standard quadratic equation $ax^2 + bx + c = 0$ (recognizing that our variable is t^* rather than x). Subtracting $x_{10} + v_{10}t^*$ from both sides, swapping sides, and reordering the terms yields

$$\frac{1}{2}a_2 t^{*2} - v_{10} t^* - x_{10} = 0$$

which is the standard form for the quadratic equation.

The quadratic formula $x = \frac{-b \pm \sqrt{b^2 - 4ac}}{2a}$ then yields

$$t^* = \frac{-(-v_{10}) \pm \sqrt{(-v_{10})^2 - 4\left(\frac{1}{2}a_2\right)(-x_{10})}}{2\left(\frac{1}{2}a_2\right)}$$

which simplifies ever so slightly to

$$t^* = \frac{v_{10} \pm \sqrt{v_{10}^2 + 2a_2 x_{10}}}{a_2}$$

Substituting values with units yields:

$$t^* = \frac{41.0 \frac{\text{m}}{\text{s}} \pm \sqrt{(41.0 \frac{\text{m}}{\text{s}})^2 + 2\left(5.00 \frac{\text{m}}{\text{s}^2}\right)123 \text{ m}}}{5.00 \frac{\text{m}}{\text{s}^2}}$$

Evaluation gives two results for t^* , namely $t^* = 19.0 \text{ s}$ and $t^* = -2.59 \text{ s}$. While the negative value is a valid solution to the mathematical equation, it corresponds to a time in the past and our expressions for the physical positions of the cars were written to be valid from time 0 on. Prior to time 0, the police car had a different acceleration than the $5.00 \frac{\text{m}}{\text{s}^2}$ that we used in the

expression for the position of the police car. Because we know that our equation is not valid for times earlier than $t = 0$ we must discard the negative solution. We are left with $t^* = 19.0 \text{ s}$ for the time when the police car catches up with the speeder. Once you find the “collision” time in a “Collision Type II” problem, the rest is easy. Referring back to the problem statement, we note that the collision time itself $t^* = 19.0 \text{ s}$ is the answer to part a, “How long does it take for the police car to catch up with the speeder?” Part b asks, “How far must the police car travel to catch up with the speeder?” At this point, to answer that, all we have to do is to substitute the

collision time t^* into equation 8-2, the equation that gives the position of the police car at any time:

$$x_2 = \frac{1}{2} a_2 t^{*2}$$

$$x_2 = \frac{1}{2} \left(5.00 \frac{\text{m}}{\text{s}^2} \right) (19.0 \text{ s})^2$$

$$x_2 = 902 \text{ m}$$

Finally, in part c of the problem statement we are asked to find the velocity of the police car when it catches up with the speeder. First we turn to the constant acceleration equations to get an expression for the velocity of the police car at as a function of time:

$$v_2 = v_{02} + a_2 t$$

The velocity of the police car at time zero is 0 yielding:

$$v_2 = a_2 t$$

To get the velocity of the police car at the “collision” time, we just have to evaluate this at $t = t^* = 19.0 \text{ s}$. This yields:

$$v_2 = \left(5.00 \frac{\text{m}}{\text{s}^2} \right) 19.0 \text{ s}$$

$$v_2 = 95.0 \frac{\text{m}}{\text{s}}$$

for the velocity of the police car when it catches up with the speeder.

9 One-Dimensional Motion Graphs

Consider an object undergoing motion along a straight-line path, where the motion is characterized by a few consecutive time intervals during each of which the acceleration is constant but typically at a different constant value than it is for the adjacent specified time intervals. The acceleration undergoes abrupt changes in value at the end of each specified time interval. The abrupt change leads to a jump discontinuity in the Acceleration vs. Time Graph and a discontinuity in the slope (but not in the value) of the Velocity vs. Time Graph (thus, there is a “corner” or a “kink” in the trace of the Velocity vs. Time graph). The thing is, the trace of the Position vs. Time graph extends smoothly through those instants of time at which the acceleration changes. Even folks that get quite proficient at generating the graphs have a tendency to erroneously include a kink in the Position vs. Time graph at a point on the graph corresponding to an instant when the acceleration undergoes an abrupt change.

Your goals here all pertain to the motion of an object that moves along a straight line path at a constant acceleration during each of several time intervals but with an abrupt change in the value of the acceleration at the end of each time interval (except for the last one) to the new value of acceleration that pertains to the next time interval. Your goals for such motion are:

- (1) Given a description (in words) of the motion of the object; produce a graph of position vs. time, a graph of velocity vs. time, and a graph of acceleration vs. time, for that motion.
- (2) Given a graph of velocity vs. time, and the initial position of the object; produce a description of the motion, produce a graph of position vs. time, and produce a graph of acceleration vs. time.
- (3) Given a graph of acceleration vs. time, the initial position of the object, and the initial velocity of the object; produce a description of the motion, produce a graph of position vs. time, and produce a graph of velocity vs. time.

The following example is provided to more clearly communicate what is expected of you and what you have to do to meet those expectations:

Example 9-1

A car moves along a straight stretch of road upon which a start line has been painted. At the start of observations, the car is already 225 m ahead of the start line and is moving forward at a steady 15 m/s. The car continues to move forward at 15 m/s for 5.0 seconds. Then it begins to speed up. It speeds up steadily, obtaining a speed of 35 m/s after another 5.0 seconds. As soon as its speed gets up to 35 m/s, the car begins to slow down. It slows steadily, coming to rest after another 10.0 seconds. Sketch the graphs of position vs. time, velocity vs. time, and acceleration vs. time pertaining to the motion of the car during the period of time addressed in the description of the motion. Label the key values on your graphs of velocity vs. time and acceleration vs. time.

Okay, we are asked to draw three graphs, each of which has the time, the same “stopwatch readings” plotted along the **horizontal**¹ axis. The first thing I do is to ask myself whether the plotted lines/curves are going to extend both above and below the time axis. This helps to determine how long to draw the axes. Reading the description of motion in the case at hand, it is evident that:

- (1) The car goes forward of the start line but it never goes behind the start line. So, the x vs. t graph will extend above the time axis (positive values of x) but not below it (negative values of x).
- (2) The car does take on positive values of velocity, but it never backs up, that is, it never takes on negative values of velocity. So, the v vs. t graph will extend above the time axis but not below it.
- (3) The car speeds up while it is moving forward (positive acceleration), and it slows down while it is moving forward (negative acceleration). So, the a vs. t graph will extend both above and below the time axis.

Next, I draw the axes, first for x vs. t , then directly below that set of axes, the axes for v vs. t , and finally, directly below that, the axes for a vs. t . Then I label the axes, both with the symbol used to represent the physical quantity being plotted along the axis and, in brackets, the units for that quantity.

Now I need to put some tick marks on the time axis. To do so, I have to go back to the question to find the relevant time intervals. I’ve already read the question twice and I’m getting tired of reading it over and over again. This time I’ll take some notes:

- At $t = 0$: $x = 225$ m
 $v = 15$ m/s
 0-5 s: $v = 15$ m/s (constant)
 5-10 s: v increases steadily from 15 m/s to 35 m/s
 10-20 s: v decreases steadily from 35 m/s to 0 m/s

From my notes it is evident that the times run from 0 to 20 seconds and that labeling every 5 seconds would be convenient. So I put four tick marks on the time axis of x vs. t . I label the origin 0, 0 and label the tick marks on the time axis 5, 10, 15, and 20 respectively. Then I draw vertical dotted lines, extending my time axis tick marks up and down the page through all the graphs. They all share the same times and this helps me ensure that the graphs relate properly to each other. In the following diagram we have the axes and the graph. Except for the labeling of key values I have described my work in a series of notes. To follow my work, please read the numbered notes, in order, from 1 to 10.

¹ How does one remember what goes on which axis? Here’s a mnemonic that applies to all “ y vs. x ” graphs. See that “ v ” in “vs.”? Yes, it is really the first letter of the word “versus”, but you should think of it as standing for “vertical.” The physical quantity that is closer to the “ v ” in “vs.” gets plotted along the *vertical* axis. For instance, in a graph of *Position vs. Time*, the Position is plotted along the vertical axis (a.k.a. the y -axis) leaving the Time for the horizontal axis (a.k.a. the x -axis). Incidentally, the word mnemonic means “memory device”, a trick, word, jingle, or image that one can use to help remember something. One more thing: You probably know this, but just in case: “a.k.a.” stands for “also known as.”

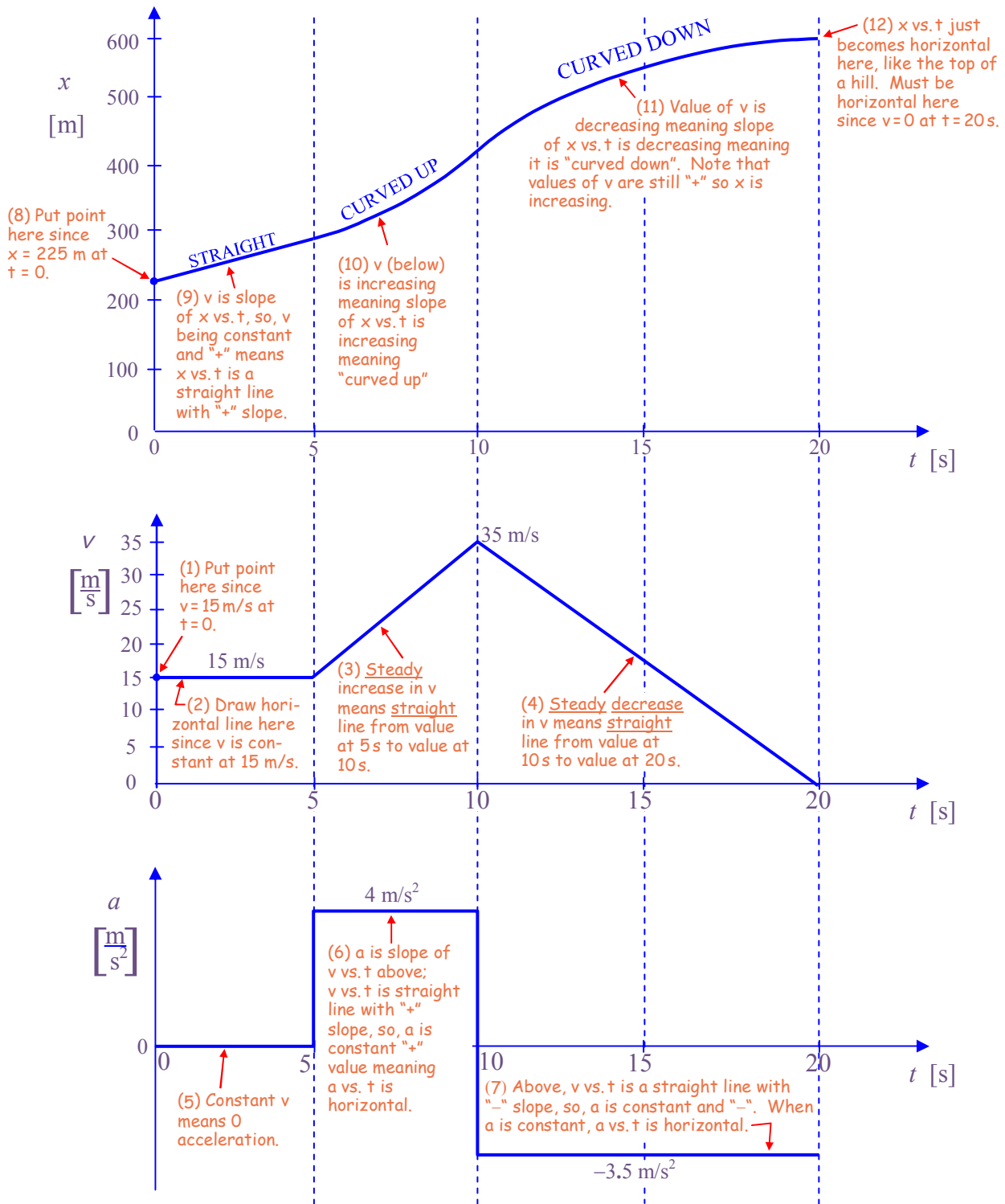

The key values on the v vs. t graph are given so the only "mystery," about the diagram above, that remains is, "How were the key values on a vs. t obtained?" Here are the answers:

On the time interval from $t = 5$ seconds to $t = 10$ seconds, the velocity changes from $15 \frac{\text{m}}{\text{s}}$ to $35 \frac{\text{m}}{\text{s}}$. Thus, on that time interval the acceleration is given by:

$$a = \frac{\Delta v}{\Delta t} = \frac{v_f - v_i}{t_f - t_i} = \frac{35 \frac{\text{m}}{\text{s}} - 15 \frac{\text{m}}{\text{s}}}{10\text{s} - 5\text{s}} = 4 \frac{\text{m}}{\text{s}^2}$$

On the time interval from $t = 10$ seconds to $t = 20$ seconds, the velocity changes from $35 \frac{\text{m}}{\text{s}}$ to $0 \frac{\text{m}}{\text{s}}$. Thus, on that time interval the acceleration is given by:

$$a = \frac{\Delta v}{\Delta t} = \frac{v_f - v_i}{t_f - t_i} = \frac{0 \frac{\text{m}}{\text{s}} - 35 \frac{\text{m}}{\text{s}}}{20\text{s} - 10\text{s}} = -3.5 \frac{\text{m}}{\text{s}^2}$$

10 Constant Acceleration Problems in Two Dimensions

In solving problems involving constant acceleration in two dimensions, the most common mistake is probably mixing the x and y motion. One should do an analysis of the x motion and a separate analysis of the y motion. The only variable common to both the x and the y motion is the time. Note that if the initial velocity is in a direction that is along neither axis, one must first break up the initial velocity into its components.

In the last few chapters we have considered the motion of a particle that moves along a straight line with constant acceleration. In such a case, the velocity and the acceleration are always directed along one and the same line, the line on which the particle moves. Here we continue to restrict ourselves to cases involving constant acceleration (constant in both magnitude and direction) but lift the restriction that the velocity and the acceleration be directed along one and the same line. If the velocity of the particle at time zero is not collinear with the acceleration, then the velocity will never be collinear with the acceleration and the particle will move along a curved path. The curved path will be confined to the plane that contains both the initial velocity vector and the acceleration vector, and in that plane, the trajectory will be a parabola. (The trajectory is just the path of the particle.)

You are going to be responsible for dealing with two classes of problems involving constant acceleration in two dimensions:

- (1) Problems involving the motion of a single particle.
- (2) Collision Type II problems in two dimensions

We use sample problems to illustrate the concepts that you must understand in order to solve two-dimensional constant acceleration problems.

Example 10-1

A horizontal square of edge length 1.20 m is situated on a Cartesian coordinate system such that one corner of the square is at the origin and the corner opposite that corner is at (1.20 m, 1.20 m). A particle is at the origin. The particle has an initial velocity of 2.20 m/s directed toward the corner of the square at (1.20 m, 1.20 m) and has a constant acceleration of 4.87 m/s^2 in the $+x$ direction. Where does the particle hit the perimeter of the square?

Solution and Discussion

Let's start with a diagram.

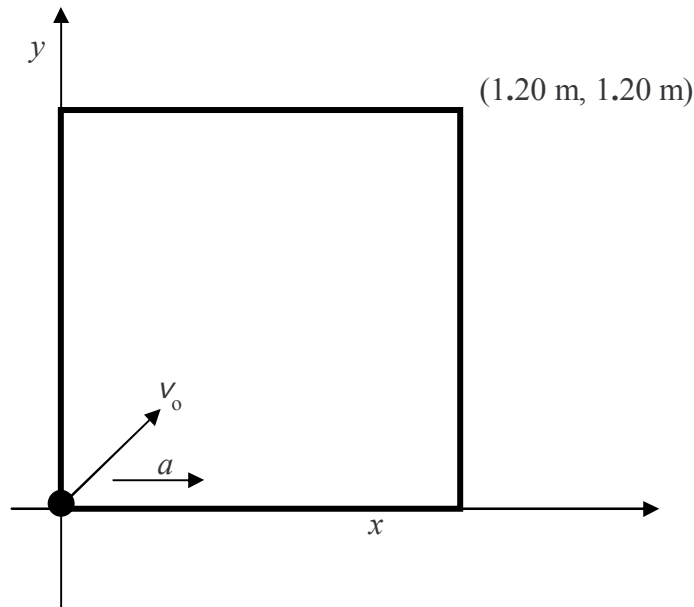

Now let's make some conceptual observations on the motion of the particle. Recall that the square is horizontal so we are looking down on it from above. It is clear that the particle hits the right side of the square because: It starts out with a velocity directed toward the far right corner. That initial velocity has an x component and a y component. The y component never changes because there is no acceleration in the y direction. The x component, however, continually increases. The particle is going rightward faster and faster. Thus, it will take less time to get to the right side of the square than it would without the acceleration and the particle will get to the right side of the square before it has time to get to the far side.

An important aside on the trajectory (path) of the particle: Consider an ordinary checker on a huge square checkerboard with squares of ordinary size (just a lot more of them than you find on a standard checkerboard). Suppose you start with the checker on the extreme left square of the end of the board nearest you (square 1) and every second, you move the checker right one square and forward one square. This would correspond to the checker moving toward the far right corner at constant velocity. Indeed you would be moving the checker along the diagonal. Now let's throw in some acceleration. Return the checker to square 1 and start moving it again. This time, each time you move the checker forward, you move it rightward one more square than you did on the previous move. So first you move it forward one square and rightward one square. Then you move it forward another square but rightward two more squares. Then forward one square and rightward three squares. And so on. With each passing second, the rightward move gets bigger. (That's what we mean when we say the rightward velocity is continually increasing.) So what would the path of the checker look like? Let's draw a picture.

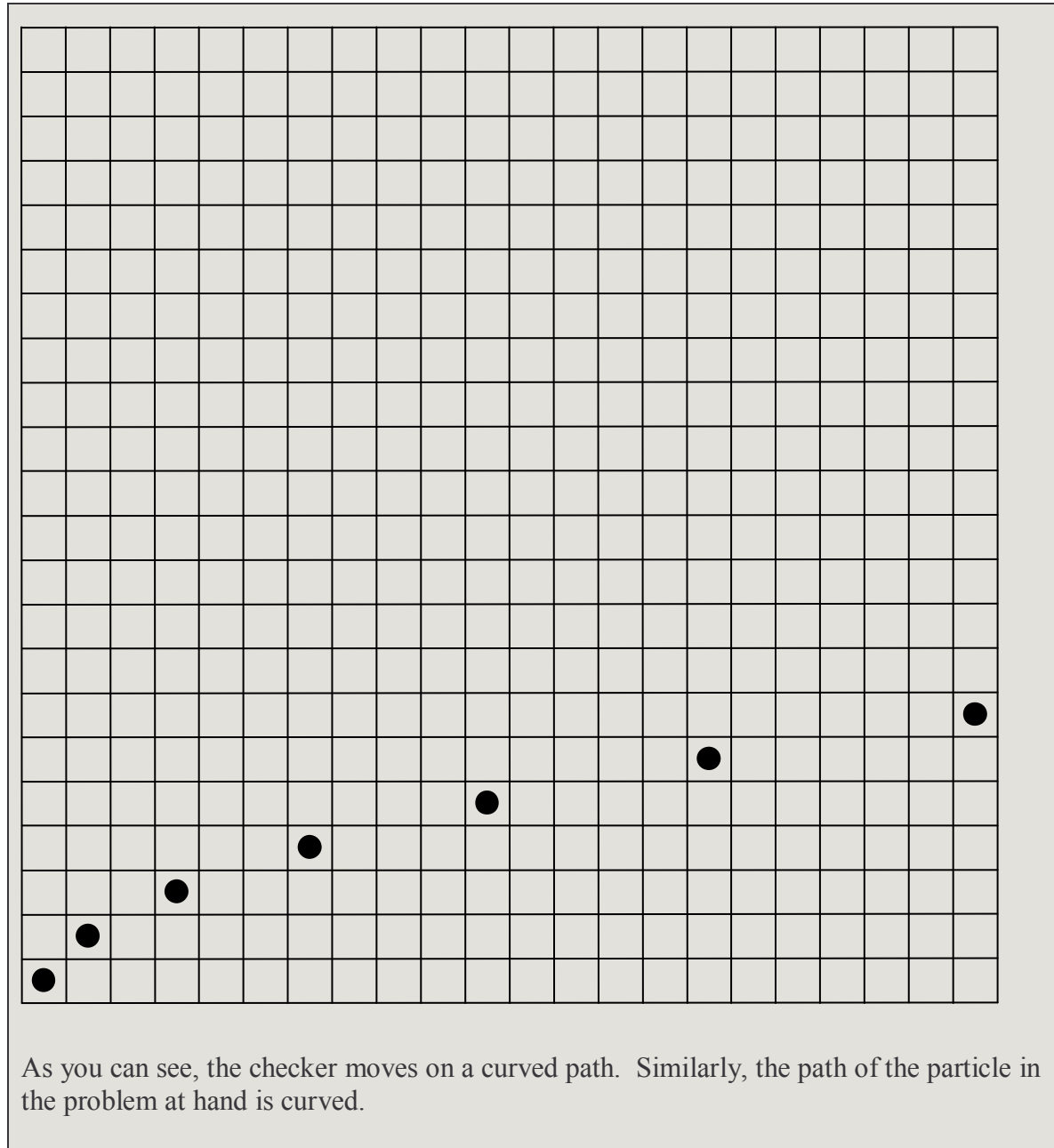

Now back to the problem at hand. The way to attack these two-dimensional constant acceleration problems is to treat the x motion and the y motion separately. The difficulty with that, in the case at hand, is that the initial velocity is neither along x nor along y but is indeed a mixture of both x motion and y motion. What we have to do is to separate it out into its x and y components. Let's proceed with that. Note that, by inspection, the angle that the velocity vector makes with the x axis is 45.0° .

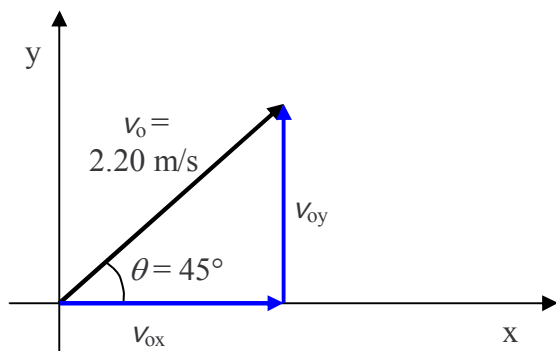

$\cos \theta = \frac{v_{ox}}{v_o}$ $v_{ox} = v_o \cos \theta$ $v_{ox} = 2.20 \frac{\text{m}}{\text{s}} \cos 45.0^\circ$ $v_{ox} = 1.556 \frac{\text{m}}{\text{s}}$	<p>By inspection (because the angle is 45.0°):</p> $v_{oy} = v_{ox}$ <p>So:</p> $v_{oy} = 1.556 \frac{\text{m}}{\text{s}}$
--	--

Now we are ready to attack the x motion and the y motion separately. Before we do, let's consider our plan of attack. We have established, by means of conceptual reasoning, that the particle will hit the right side of the square. This means that we already have the answer to half of the question "Where does the particle hit the perimeter of the square?" It hits it at $x = 1.20$ m and $y = ?$. All we have to do is to find out the value of y . We have established that it is the x motion that determines the time it takes for the particle to hit the perimeter of the square. It hits the perimeter of the square at that instant in time when x achieves the value of 1.20 m. So our plan of attack is to use one or more of the x -motion constant acceleration equations to determine the time at which the particle hits the perimeter of the square and to plug that time into the appropriate y -motion constant acceleration equation to get the value of y at which the particle hits the side of the square. Let's go for it.

x motion

We start with the equation that relates position and time:

$$x = \overset{0}{x_0} + v_{ox}t + \frac{1}{2}a_x t^2 \quad (\text{We need to find the time that makes } x = 1.20 \text{ m.})$$

The x component of the acceleration is the total acceleration, that is $a_x = a$. Thus,

$$x = v_{ox}t + \frac{1}{2}at^2$$

Recognizing that we are dealing with a quadratic equation we get it in the standard form of the quadratic equation.

$$\frac{1}{2}at^2 + v_{ox}t - x = 0$$

Now we apply the quadratic formula:

$$t = \frac{-v_{ox} \pm \sqrt{v_{ox}^2 - 4\left(\frac{1}{2}a\right)(-x)}}{2\left(\frac{1}{2}a_x\right)}$$

$$t = \frac{-v_{ox} \pm \sqrt{v_{ox}^2 + 2ax}}{a_x}$$

Substituting values with units (and, in this step, doing no evaluation) we obtain:

$$t = \frac{-1.556 \frac{\text{m}}{\text{s}} \pm \sqrt{\left(1.556 \frac{\text{m}}{\text{s}}\right)^2 + 2\left(4.87 \frac{\text{m}}{\text{s}^2}\right)1.20 \text{ m}}}{4.87 \frac{\text{m}}{\text{s}^2}}$$

Evaluating this expression yields:

$$t = 0.4518 \text{ s, and } t = -1.091 \text{ s.}$$

We are solving for a future time so we eliminate the negative result on the grounds that it is a time in the past. We have found that the particle arrives at the right side of the square at time $t = 0.4518 \text{ s}$. Now the question is, “What is the value of y at that time?”

***y*-motion**

Again we turn to the constant acceleration equation relating position to time, this time writing it in terms of the *y* variables:

$$y = \overset{0}{y_0} + v_{oy} t + \frac{1}{2} \overset{0}{a_y} t^2$$

We note that y_0 is zero because the particle is at the origin at time 0 and a_y is zero because the acceleration is in the +*x* direction meaning it has no *y* component. Rewriting this:

$$y = v_{oy} t$$

Substituting values with units,

$$y = 1.556 \frac{\text{m}}{\text{s}} (0.4518 \text{ s})$$

evaluating, and rounding to three significant figures yields:

$$y = 0.703 \text{ m.}$$

Thus, the particle hits the perimeter of the square at

$$(1.20 \text{ m}, 0.703 \text{ m})$$

Next, let's consider a 2-D Collision Type II problem. Solving a typical 2-D Collision Type II problem involves finding the trajectory of one of the particles, finding when the other particle crosses that trajectory, and establishing where the first particle is when the second particle crosses that trajectory. If the first particle is at the point on its own trajectory where the second particle crosses that trajectory then there is a collision. In the case of objects rather than particles, one often has to do some further reasoning to solve a 2-D Collision Type II problem. Such reasoning is illustrated in the following example involving a rocket.

Example 10-2

The positions of a particle and a thin (treat it as being as thin as a line) rocket of length 0.280 m are specified by means of Cartesian coordinates. At time 0 the particle is at the origin and is moving on a horizontal surface at 23.0 m/s at 51.0° . It has a constant acceleration of 2.43 m/s^2 in the +y direction. At time 0 the rocket is at rest and it extends from $(-0.280 \text{ m}, 50.0 \text{ m})$ to $(0, 50.0 \text{ m})$, but it has a constant acceleration in the +x direction. What must the acceleration of the rocket be in order for the particle to hit the rocket?

Solution

Based on the description of the motion, the rocket travels on the horizontal surface along the line $y = 50.0 \text{ m}$. Let's figure out where and when the particle crosses this line. Then we'll calculate the acceleration that the rocket must have in order for the nose of the rocket to be at that point at that time and repeat for the tail of the rocket. Finally, we'll quote our answer as being any acceleration in between those two values.

When and where does the particle cross the line $y = 50.0 \text{ m}$?

We need to treat the particle's x motion and the y motion separately. Let's start by breaking up the initial velocity of the particle into its x and y components.

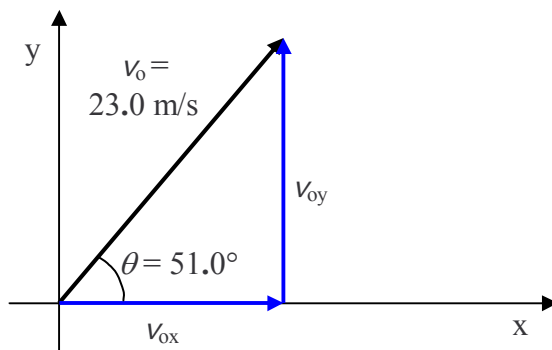

$\cos \theta = \frac{v_{ox}}{v_o}$ $v_{ox} = v_o \cos \theta$ $v_{ox} = 23.0 \frac{\text{m}}{\text{s}} \cos 51.0^\circ$ $v_{ox} = 14.47 \frac{\text{m}}{\text{s}}$	$\sin \theta = \frac{v_{oy}}{v_o}$ $v_{oy} = v_o \sin \theta$ $v_{oy} = 23.0 \frac{\text{m}}{\text{s}} \sin 51.0^\circ$ $v_{oy} = 17.87 \frac{\text{m}}{\text{s}}$
--	--

Now in this case, it is the y motion that determines when the particle crosses the trajectory of the rocket because it does so when $y = 50.0$ m. So let's address the y motion first.

y motion of the particle

$$y = \overset{0}{y_0} + v_{oy}t + \frac{1}{2}a_y t^2$$

Note that we can't just assume that we can cross out y_0 but in this case the time zero position of the particle was given as $(0, 0)$ meaning that y_0 is indeed zero for the case at hand. Now we solve for t :

$$y = v_{oy}t + \frac{1}{2}a_y t^2$$

$$\frac{1}{2}a_y t^2 + v_{oy}t - y = 0$$

$$t = \frac{-v_{oy} \pm \sqrt{v_{oy}^2 - 4\left(\frac{1}{2}a_y\right)(-y)}}{2\left(\frac{1}{2}a_y\right)}$$

$$t = \frac{-v_{oy} \pm \sqrt{v_{oy}^2 + 2a_y y}}{a_y}$$

$$t = \frac{-17.87 \frac{\text{m}}{\text{s}} \pm \sqrt{\left(17.87 \frac{\text{m}}{\text{s}}\right)^2 + 2\left(2.43 \frac{\text{m}}{\text{s}^2}\right)50.0 \text{ m}}}{2.43 \frac{\text{m}}{\text{s}^2}}$$

$$t = 2.405 \text{ s, and } t = -17.11 \text{ s.}$$

Again, we throw out the negative solution because it represents an instant in the past and we want a future instant.

Now we turn to the x motion to determine where the particle crosses the trajectory of the rocket.

x motion of the particle

Again we turn to the constant acceleration equation relating position to time, this time writing it in terms of the x variables:

$$x = \overset{0 \text{ (because the particle starts at the origin)}}{x_0} + v_{ox}t + \frac{1}{2} \overset{0 \text{ (because the acceleration is in the y direction)}}{a_x} t^2$$

$$x = v_{ox} t$$

$$x = 14.47 \frac{\text{m}}{\text{s}} (2.405 \text{ s})$$

$$x = 34.80 \text{ m.}$$

So the particle crosses the rocket's path at (34.80 m, 50.0 m) at time $t = 2.450 \text{ s}$. Let's calculate the acceleration that the rocket would have to have in order for the nose of the rocket to be there at that instant. The rocket has x motion only. It is always on the line $y = 50.0 \text{ m}$.

Motion of the Nose of the Rocket

$$x'_n = \overset{0}{x'_{on}} + \overset{0}{v'_{on}} t + \frac{1}{2} a'_n t^2$$

where we use the subscript n for "nose" and a prime to indicate "rocket." We have crossed out x'_{on} because the nose of the rocket is at (0, 50.0 m) at time zero, and we have crossed out v'_{on} because the rocket is at rest at time zero.

$$x'_n = \frac{1}{2} a'_n t^2$$

Solving for a'_n yields:

$$a'_n = \frac{2x'_n}{t^2}$$

Now we just have to evaluate this expression at $t = 2.405 \text{ s}$, the instant when the particle crosses the trajectory of the rocket, and at $x'_n = x = 34.80 \text{ m}$, the value of x at which the particle crosses the trajectory of the rocket.

$$a'_n = \frac{2(34.80 \text{ m})}{(2.405 \text{ s})^2}$$

$$a'_n = 12.0 \frac{\text{m}}{\text{s}^2}$$

It should be emphasized that the n for "nose" is not there to imply that the nose of the rocket has a different acceleration than the tail; rather, the whole rocket must have the acceleration

$a'_n = 12.0 \frac{\text{m}}{\text{s}^2}$ in order for the particle to hit the rocket in the nose. Now let's find the acceleration a'_t that the entire rocket must have in order for the particle to hit the rocket in the tail.

Motion of the Tail of the Rocket

$$x'_t = x'_{\text{ot}} + \overset{0}{\cancel{v'_{\text{ot}}}} t + \frac{1}{2} a'_t t^2$$

where we use the subscript t for “tail” and a prime to indicate “rocket.” We have crossed out v'_{ot} because the rocket is at rest at time zero, but x'_{ot} is not zero because the tail of the rocket is at $(-0.280, 50.0 \text{ m})$ at time zero.

$$x'_t = x'_{\text{ot}} + \frac{1}{2} a'_t t^2$$

Solving for a'_t yields:

$$a'_t = \frac{2[x'_t - x'_{\text{ot}}]}{t^2}$$

Evaluating at $t = 2.405 \text{ s}$ and $x'_t = x = 34.80 \text{ m}$ yields

$$a'_t = \frac{2[34.80 \text{ m} - (-0.280 \text{ m})]}{(2.405 \text{ s})^2}$$

$$a'_t = 12.1 \frac{\text{m}}{\text{s}^2}$$

as the acceleration that the rocket must have in order for the particle to hit the tail of the rocket.

Thus:

The acceleration of the rocket must be somewhere between $12.0 \frac{\text{m}}{\text{s}^2}$ and $12.1 \frac{\text{m}}{\text{s}^2}$, inclusive, in order for the rocket to be hit by the particle.

11 Relative Velocity

Vectors add like vectors, not like numbers. Except in that very special case in which the vectors you are adding lie along one and the same line, you can't just add the magnitudes of the vectors.

Imagine that you have a dart gun with a **muzzle velocity**¹ of 45 mph. Further imagine that you are on a bus traveling along a straight highway at 55 mph and that you point the gun so that the barrel is level and pointing directly forward, toward the front of the bus. Assuming no recoil, as it leaves the muzzle of the gun, how fast is the dart traveling relative to the road? That's right! 100 mph. The dart is already traveling forward at 55 mph relative to the road just because it is on a bus that is moving at 55 mph relative to the road. Add to that the velocity of 45 mph that it acquires as a result of the firing of the gun and you get the total velocity of the dart relative to the road. This problem is an example of a class of vector addition problems that come under the heading of "Relative Velocity." It is a particularly easy vector addition problem because both velocity vectors are in the same direction. The only challenge is the vector addition diagram, since the resultant is right on top of the other two. We displace it to one side a little bit in the diagram below so that you can see all the vectors. Defining

- \vec{v}_{BR} to be the velocity of the bus relative to the road,
- \vec{v}_{DB} to be the velocity of the dart relative to the bus, and
- \vec{v}_{DR} to be the velocity of the dart relative to the road; we have

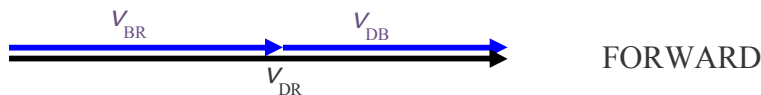

The vector addition problem this illustrates is

$$\vec{v}_{DR} = \vec{v}_{BR} + \vec{v}_{DB}$$

If we define the forward direction to be the positive direction,



then, because the vectors we are adding are both in the same direction, we are indeed dealing with that very special case in which the magnitude of the resultant is just the sum of the magnitudes of the vectors we are adding:

¹ The muzzle velocity of any gun is the velocity, relative to the gun, with which the bullet, BB, or dart exits the barrel of the gun. The barrel exit, the opening at the front end of the gun, is called the muzzle of the gun, hence the name, "muzzle velocity."

$$\vec{v}_{DR} = \vec{v}_{BR} + \vec{v}_{DB}$$

$$v_{DR} = v_{BR} + v_{DB}$$

$$v_{DR} = 55 \text{ mph} + 45 \text{ mph}$$

$$v_{DR} = 100 \text{ mph}$$

$$\vec{v}_{DR} = 100 \text{ mph in the direction in which the bus is traveling}$$

You already know all the concepts you need to know to solve relative velocity problems (you know what velocity is and you know how to do vector addition) so the best we can do here is to provide you with some more worked examples. We've just addressed the easiest kind of relative velocity problem, the kind in which all the velocities are in one and the same direction. The second easiest kind is the kind in which the two velocities to be added are in opposite directions.

Example 11-1

A bus is traveling along a straight highway at a constant 55 mph. A person sitting at rest on the bus fires a dart gun that has a muzzle velocity of 45 mph straight backward, (toward the back of the bus). Find the velocity of the dart, relative to the road, as it leaves the gun.

Again defining:

\vec{v}_{BR} to be the velocity of the bus relative to the road,

\vec{v}_{DB} to be the velocity of the dart relative to the bus, and

\vec{v}_{DR} to be the velocity of the dart relative to the road, and

defining the forward direction to be the positive direction; we have

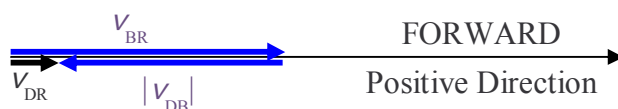

$$\vec{v}_{DR} = \vec{v}_{BR} + \vec{v}_{DB}$$

$$v_{DR} = v_{BR} - |v_{DB}|$$

$$v_{DR} = 55 \text{ mph} - 45 \text{ mph}$$

$$v_{DR} = 10 \text{ mph}$$

$$\vec{v}_{DR} = 10 \text{ mph in the direction in which the bus is traveling}$$

It would be odd looking at that dart from the side of the road. Relative to you it would still be moving in the direction that the bus is traveling, tail first, at 10 mph.

The next easiest kind of vector addition problem is the kind in which the vectors to be added are at right angles to each other. Let's consider a relative velocity problem involving that kind of vector addition problem.

Example 11-2

A boy sitting in a car that is traveling due north at 65 mph aims a BB gun (a gun which uses a compressed gas to fire a small metal or plastic ball called a BB), with a muzzle velocity of 185 mph, due east, and pulls the trigger. Recoil (the backward movement of the gun resulting from the firing of the gun) is negligible. In what compass direction does the BB go?

Defining

\vec{v}_{CR} to be the velocity of the car relative to the road,

\vec{v}_{BC} to be the velocity of the BB relative to the car, and

\vec{v}_{BR} to be the velocity of the BB relative to the road; we have

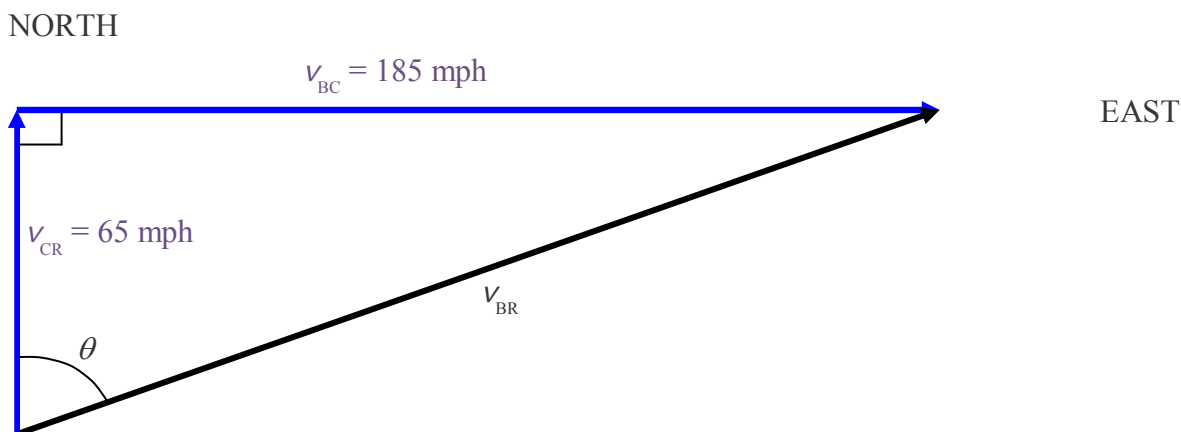

$$\tan \theta = \frac{v_{BC}}{v_{CR}}$$

$$\theta = \tan^{-1} \frac{v_{BC}}{v_{CR}}$$

$$\theta = \tan^{-1} \frac{185 \text{ mph}}{65 \text{ mph}}$$

$$\theta = 70.6^\circ$$

The BB travels in the direction for which the compass heading is 70.6° .

Example 11-3

A boat is traveling across a river that flows due east at 8.50 m/s. The compass heading of the boat is 15.0° . Relative to the water, the boat is traveling straight forward (in the direction in which the boat is pointing) at 11.2 m/s. How fast and which way is the boat moving relative to the banks of the river?

Okay, here we have a situation in which the boat is being carried downstream by the movement of the water at the same time that it is moving relative to the water. Note the given information means that if the water was dead still, the boat would be going 11.2 m/s at 15.0° East of North. The water, however, is not still. Defining

- \vec{v}_{WG} to be the velocity of the water relative to the ground,
- \vec{v}_{BW} to be the velocity of the boat relative to the water, and
- \vec{v}_{BG} to be the velocity of the boat relative to the ground; we have

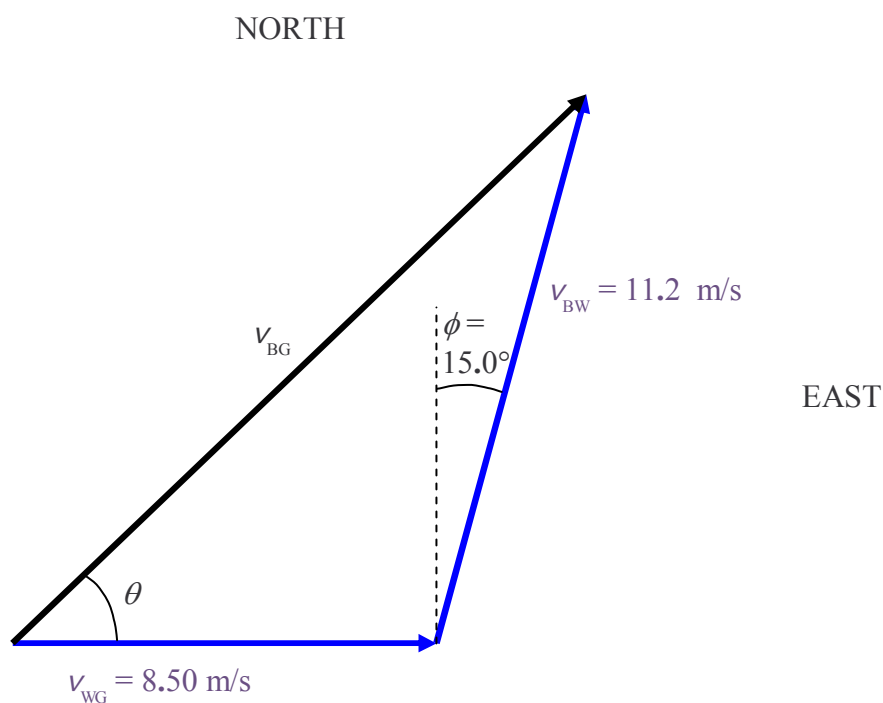

Solving this problem is just a matter of following the vector addition recipe. First we define $+x$ to be eastward and $+y$ to be northward. Then we draw the vector addition diagram for \vec{v}_{WG} . Breaking it up into components is trivial since it lies along the x -axis:

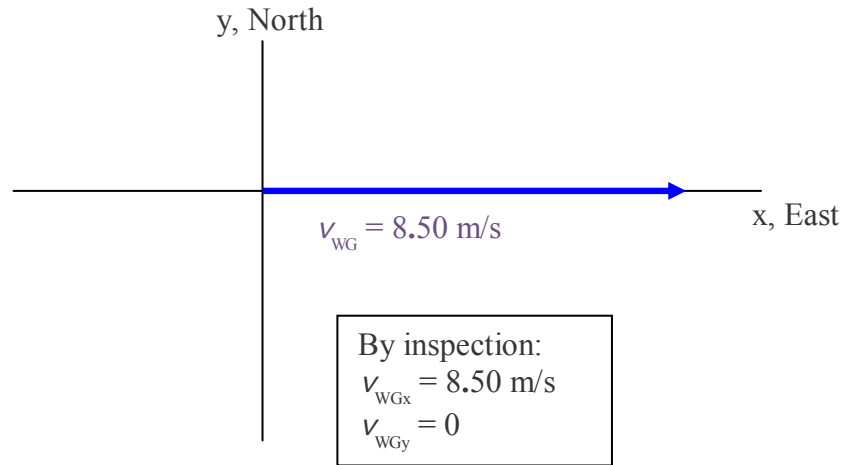

Breaking \vec{v}_{BW} does involve a little bit of work:

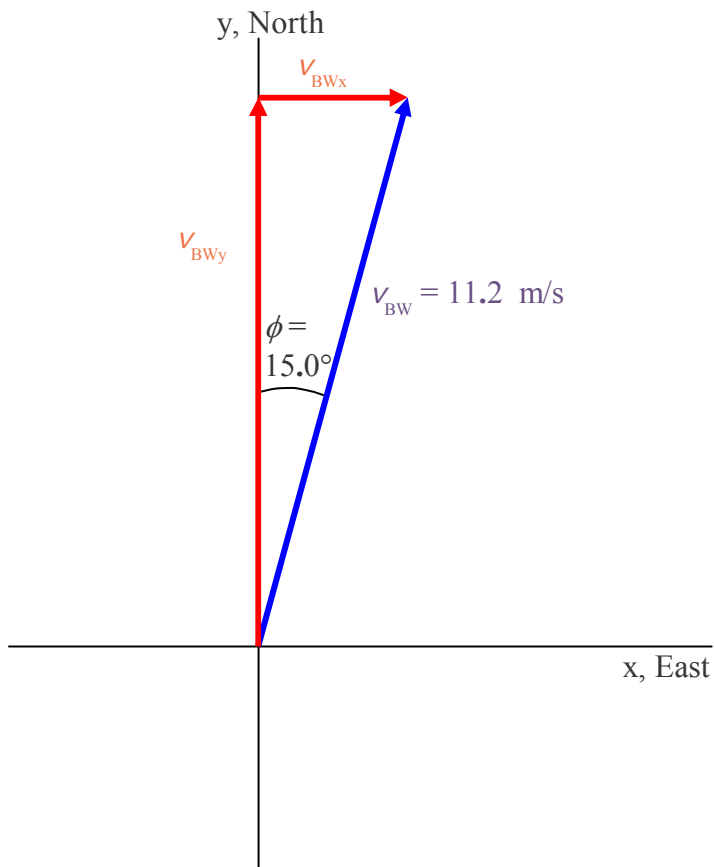

$$\sin \theta = \frac{v_{BWx}}{v_{BW}}$$

$$v_{BWx} = v_{BW} \sin \theta$$

$$v_{BWx} = 11.2 \frac{\text{m}}{\text{s}} \sin(15.0^\circ)$$

$$v_{BWx} = 2.899 \frac{\text{m}}{\text{s}}$$

$$\cos \theta = \frac{v_{BW_y}}{v_{BW}}$$

$$v_{BW_y} = v_{BW} \cos \theta$$

$$v_{BW_y} = 11.2 \frac{\text{m}}{\text{s}} \cos(15.0^\circ)$$

$$v_{BW_y} = 10.82 \frac{\text{m}}{\text{s}}$$

Now we add the x components to get the x-component of the resultant

$$v_{BGx} = v_{WGx} + v_{BWx}$$

$$v_{BGx} = 8.50 \frac{\text{m}}{\text{s}} + 2.899 \frac{\text{m}}{\text{s}}$$

$$v_{BGx} = 11.299 \frac{\text{m}}{\text{s}}$$

and we add the y components to get the y-component of the resultant:

$$v_{BGy} = v_{Wgy} + v_{Bwy}$$

$$v_{BGy} = 0 \frac{\text{m}}{\text{s}} + 10.82 \frac{\text{m}}{\text{s}}$$

$$v_{BGy} = 10.82 \frac{\text{m}}{\text{s}}$$

Now we have both components of the velocity of the boat relative to the ground. We need to draw the vector component diagram for \vec{v}_{BG} to determine the direction and magnitude of the velocity of the boat relative to the ground.

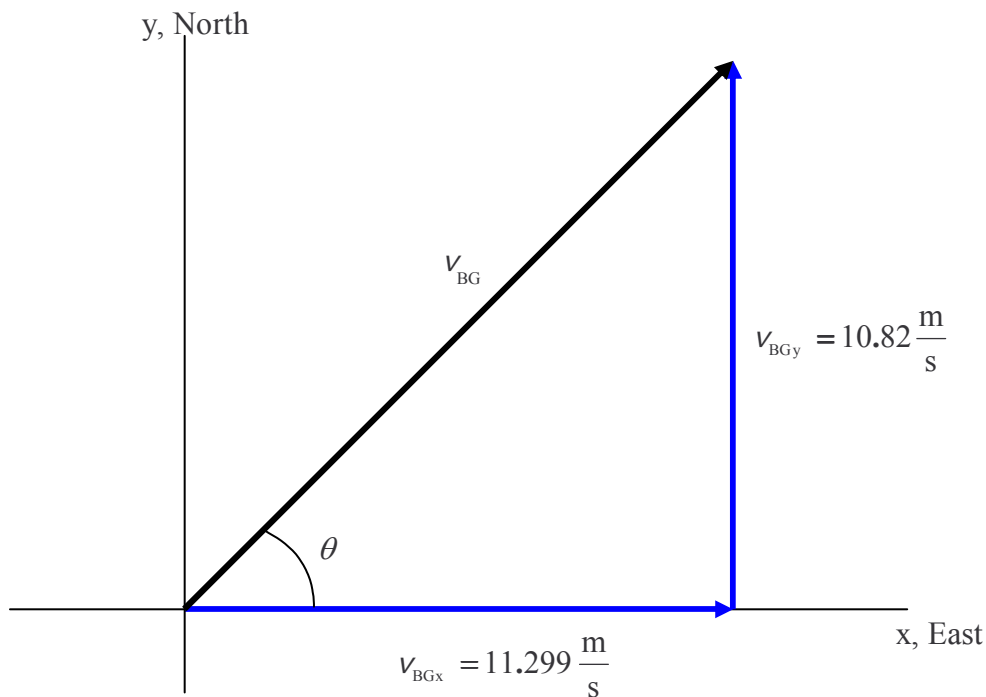

We then use the Pythagorean Theorem to get the magnitude of the velocity of the boat relative to the ground,

$$v_{BG} = \sqrt{v_{BGx}^2 + v_{BGy}^2}$$

$$v_{BG} = \sqrt{(11.299 \text{ m/s})^2 + (10.82 \text{ m/s})^2}$$

$$v_{BG} = 15.64 \text{ m/s}$$

and the definition of the tangent to determine the direction of \vec{v}_{BG} :

$$\tan \theta = \frac{v_{BGy}}{v_{BGx}}$$

$$\theta = \tan^{-1} \frac{v_{BGy}}{v_{BGx}}$$

$$\theta = \tan^{-1} \frac{10.82 \text{ m/s}}{11.299 \text{ m/s}}$$

$$\theta = 43.8^\circ$$

Hence, $\vec{v}_{BG} = 15.6 \text{ m/s}$ at 43.8° North of East.

12 Gravitational Force Near the Surface of the Earth, First Brush with Newton's 2nd Law

Some folks think that every object near the surface of the earth has an acceleration of 9.8 m/s^2 downward relative to the surface of the earth. That just isn't so. In fact, as I look around the room in which I write this sentence, all the objects I see have zero acceleration relative to the surface of the earth. Only when it is in freefall, that is, only when nothing is touching or pushing or pulling on the object except for the gravitational field of the earth, will an object experience an acceleration of 9.8 m/s^2 downward relative to the surface of the earth.

Gravitational Force near the Surface of the Earth

We all live in the invisible gravitational field of the earth. Mass is always accompanied by a surrounding gravitational field. Any object that has mass, including the earth, is surrounded by a gravitational field. The greater the mass of the object, the stronger the field is. The earth has a huge mass; hence, it creates a strong gravitational field in the region of space around it. The gravitational field is a force-per-mass at each and every point in the region around the object, always ready and able to exert a force on any particle that finds itself in the gravitational field. The earth's gravitational field exists everywhere around the earth, not only everywhere in the air, but out beyond the atmosphere in outer space, and inside the earth as well. The effect of the gravitational field is to exert a force on any particle, any "victim," that finds itself in the field. The force on the victim depends on both a property of the victim itself, namely its mass, and on a property of the point in space at which the particle finds itself, the force-per-mass of the gravitational field at that point. The force exerted on the victim by the gravitational field is just the mass of the victim times the force-per-mass value of the gravitational field at the location of the victim.

Hold a rock in the palm of your hand. You can feel that something is pulling the rock downward. It causes the rock to make a temporary indentation in the palm of your hand and you can tell that you have to press upward on the bottom of the rock to hold it up against that downward pull. The "something" is the field that we have been talking about. It is called the *gravitational field of the earth*. It has both magnitude and direction so we use a vector variable, the symbol \vec{g} to represent it. In general, the magnitude and the direction of a gravitational field both vary from point to point in the region of space where the gravitational field exists. The gravitational field of the earth, near the surface of the earth is however, to a very good approximation, much simpler than that. To a very good approximation, the gravitational field of the earth has the same value at all points near the surface of the earth, and it always points toward the center of the earth, a direction that we normally think of as downward. To a very good approximation,

$$\vec{g} = 9.80 \frac{\text{N}}{\text{kg}} \quad \text{downward} \quad (12-1)$$

at all points near the surface of the earth. The fact that the gravitational field is a force-per-mass at every point in space means that it must have units of force-per-mass. Indeed, the N (newton)

appearing in the value $9.80 \frac{\text{N}}{\text{kg}}$ is the SI unit of force (how strong the push or pull on the object is) and the kg (kilogram) is the SI unit of mass, so the N/kg is indeed a unit of force-per-mass.

The gravitational force exerted on an object by the earth's gravitational field (or that of another planet when the object is near the surface of that other planet) is sometimes called the weight of the object. To stress that the gravitational force is a force that is being exerted on the object, rather than a property of the object itself, we will refer to it as the gravitational force. The gravitational force \vec{F}_g exerted on an object of mass m by the gravitational field of the earth is given by

$$\vec{F}_g = m\vec{g} \quad (12-2)$$

The product of a scalar and a vector is a new vector in the same direction as the original vector. Hence the earth's gravitational force is in the same direction as the gravitational field, namely downward, toward the center of the earth. The magnitude of the product of a scalar and a vector is the product of the absolute value of the scalar and the magnitude of the vector. [Recall that the magnitude of a vector is how big it is. A vector has both magnitude (how big) and direction (which way). So for instance, the magnitude of the force vector $\vec{F} = 15 \text{ N downward}$, is $F = 15 \text{ newtons}$.] Hence,

$$F_g = mg \quad (12-3)$$

relates the magnitude of the gravitational force to the magnitude of the gravitational field. The bottom line is that every object *near the surface* of the earth experiences a downward-directed gravitational force whose magnitude is given by $F_g = mg$ where m is the mass of the object and

g is $9.80 \frac{\text{N}}{\text{kg}}$.

When the Gravitational Force is the Only Force on an Object

If there is a non-zero net force on an object, that object is experiencing acceleration in the same direction as that net force. How much acceleration depends on how big the net force is and on the mass of the object whose acceleration we are talking about, the object upon which the net force acts. In fact, the acceleration is directly proportional to the force. The constant of proportionality is the reciprocal of the mass of the object.

$$\vec{a} = \frac{1}{m} \sum \vec{F} \quad (12-4)^1$$

¹ Equation 12-4 is known as Newton's 2nd Law. Newton's 2nd Law can also be written $\sum \vec{F} = \frac{d\vec{p}}{dt}$ where \vec{p} is the momentum of the object. This latter equation is valid at all possible speeds, even at speeds close to the speed of light. To derive equation 12-4 from it, we use $\vec{p} = m\vec{v}$ which is only valid for speeds small compared to the speed of light. Hence, equation 12-4 is only valid for speeds small compared to the speed of light ($3.00 \times 10^8 \text{ m/s}$). Also,

The expression $\sum \vec{F}$ means “the sum of the forces acting on the object.” It is a vector sum. It is the net force acting on the object. The mass m is the inertia of the object, the object's inherent resistance to a change in its velocity. (Inherent means “of itself.”) Note that the factor $\frac{1}{m}$ in equation 12-4:

$$\vec{a} = \frac{1}{m} \sum \vec{F}$$

means that the bigger the mass of the object, the smaller its acceleration will be, for a given net force. Equation 12-4 is a concise statement of a multitude of experimental results. It is referred to as “Newton's 2nd Law.” Here, we want to apply it to find the acceleration of an object in freefall near the surface of the earth.

Whenever you apply Newton's 2nd Law, you are required to draw a free body diagram of the object whose acceleration is under investigation. In a free body diagram, you depict the object (in our case it is an arbitrary object, let's think of it as a rock) free from all its surroundings, and then draw an arrow on it for each force acting on the object. Draw the arrow with the tail touching the object, and the arrow pointing in the direction of the force. Label the arrow with the symbol used to represent the magnitude of the force. Finally, draw an arrow near, but not touching, the object. Draw the arrow so that it points in the direction of the acceleration of the object and label it with a symbol chosen to represent the magnitude of the acceleration. Here we use the symbol a_g for the acceleration to remind us that it is the acceleration due to the earth's gravitational field \vec{g} .

Free Body Diagram for an Object in Freefall near the Surface of the Earth

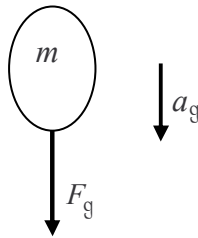

The next step in applying Newton's 2nd Law is to write it down.

$$a_{\downarrow} = \frac{1}{m} \sum F_{\downarrow} \quad (12-5)$$

the concept of force proves impractical on the atomic scale and smaller (distances less than about 1×10^{-9} m). Such small scales are the realm of quantum mechanics where energy and momentum still play a major role.

Note that equation 12-4:

$$\vec{a} = \frac{1}{m} \sum \vec{F}$$

is a vector equation. As such it can be considered to be three equations in one—one equation for each of a total of three possible mutually-orthogonal (meaning perpendicular to each other) coordinate directions in space. In the case at hand, all the vectors, (hey, there are only two, the gravitational force vector and the acceleration vector) are parallel to one and the same line, namely the vertical, so we only need one of the equations. In equation 12-5,

$$a_{\downarrow} = \frac{1}{m} \sum F_{\downarrow}$$

we use arrows as subscripts—the arrow shaft alignment specifies the line along which we are summing the forces and the arrowhead specifies the direction along that line that we choose to call the positive direction. In the case at hand, referring to equation 12-5, we note that the shafts of the arrows are vertical, meaning that we are summing forces along the vertical and that we are dealing with an acceleration along the vertical. Also in equation 12-5, we note that the arrowheads are pointing downward meaning that I have chosen to call downward the positive direction, which, by default, means that upward is the negative direction. (I chose to call downward positive because both of the vectors in the free body diagram are downward.)

Next we replace a_{\downarrow} with what it is in the free body diagram,

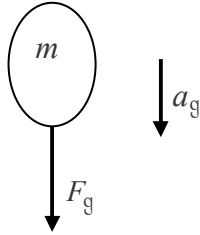

namely a_g , and we replace $\sum F_{\downarrow}$ with the sum of the vertical forces in the free body diagram, counting downward forces as positive contributions to the sum, and upward forces as negative contributions to the sum. This is an easy substitution in the case at hand because there is only one force on the free body diagram, namely the gravitational force, the downward force of magnitude F_g . The result of our substitutions is:

$$a_g = \frac{1}{m} F_g \quad (12-6)$$

The F_g in equation 12-6 is the magnitude of the gravitational force, that force which you already read about at the start of this chapter. It is given in terms of the mass of the object and the magnitude of the earth's gravitational field g by equation 12-3, $F_g = mg$. Replacing the F_g in

equation 12-6, $a_g = \frac{1}{m} F_g$, with the mg to which it is equivalent we have

$$a_g = \frac{1}{m} mg \quad (12-7)$$

Now the m that appears in the fraction $\frac{1}{m}$ is the inertia of the object. It is the amount of inherent resistance that the object has to a change in its velocity and is a measure of the total amount of material making up the object. The m appearing in the mg part of the expression (equation 12-7) is the gravitational mass of the object, the quantity that, in concert with the gravitational field at the location of the object determines the force on the object. It is also a measure of the total amount of material making up the object. As it turns out, the inertial mass and the gravitational mass of the same object are identical (which is why we use one and the same symbol m for each) and, in equation 12-7, they cancel. Thus,

$$a_g = g \quad (12-8)$$

Now g is the magnitude of the earth's gravitational field vector at the location of the object. $g = 9.80 \text{ N/kg}$ and a_g , being an acceleration has to have units of acceleration, namely, m/s^2 .

Fortunately a newton is a $\frac{\text{kg} \cdot \text{m}}{\text{s}^2}$ so the units of g , namely N/kg , do indeed work out to be $\frac{\text{m}}{\text{s}^2}$.

Thus

$$a_g = 9.80 \frac{\text{m}}{\text{s}^2} \quad (12-9)$$

Now this is “wild”! The acceleration of an object in freefall does not depend on its mass. You saw the masses cancel. The same thing that makes an object heavy makes it “sluggish.”

One-Dimensional Free-Fall, a.k.a., One-Dimensional Projectile Motion

If you throw an object straight up, or simply release it from rest, or throw it straight down; assuming that the force of air resistance is negligibly small compared to the gravitational force: the object will be in freefall from the instant it loses contact with your hand until the last instant before it hits the ground (or whatever it does eventually hit), and the object will travel along a straight line path with a constant acceleration of $9.80 \frac{\text{m}}{\text{s}^2}$ downward.

Consider the case in which the object is thrown straight up. The whole time it is in freefall, the object experiences an acceleration of $9.80 \frac{\text{m}}{\text{s}^2}$ downward. While the object is on the way up, the downward acceleration means that the object is slowing down. At the top of its motion, when the velocity changes from being an upward velocity to being a downward velocity, and hence, for an instant is zero, the downward acceleration means that the velocity is changing from zero to a non-zero downward velocity. And on the way down, the downward acceleration means that the velocity is increasing in the downward direction.

13 Freefall, a.k.a. Projectile Motion

*The constant acceleration equations apply from the first instant in time after the projectile leaves the launcher to the last instant in time before the projectile hits something, such as the ground. Once the projectile makes contact with the ground, the ground exerts a huge force on the projectile causing a drastic change in the acceleration of the projectile over a very short period of time until, in the case of a projectile that doesn't bounce, both the acceleration and the velocity become zero. To take this zero value of velocity and plug it into constant acceleration equations that are devoid of post-ground-contact acceleration information is a big mistake. In fact, at that last instant in time during which the constant acceleration equations still apply, when the projectile is at ground level but has not yet made contact with the ground, (assuming that ground level is the lowest elevation achieved by the projectile) the magnitude of the velocity of the projectile is at its **biggest** value, as far from zero as it ever gets!*

Consider an object in freefall with a non-zero initial velocity directed either horizontally forward; or both forward and vertically (either upward or downward). The object will move forward, and upward or downward—perhaps upward and then downward—while continuing to move forward. In all cases of freefall, the motion of the object (typically referred to as the *projectile* when freefall is under consideration) all takes place within a single vertical plane. We can define that plane to be the x-y plane by defining the forward direction to be the x direction and the upward direction to be the y direction.

One of the interesting things about projectile motion is that the horizontal motion is independent of the vertical motion. Recall that in freefall, an object continually experiences a downward acceleration of $9.80 \frac{\text{m}}{\text{s}^2}$ but has no horizontal acceleration. This means that if you fire a projectile so that it is approaching a wall at a certain speed, it will continue to get closer to the wall at that speed, independently of whether it is also moving upward and/or downward as it approaches the wall. An interesting consequence of the independence of the vertical and horizontal motion is the fact that, neglecting air resistance, if you fire a bullet horizontally from, say, shoulder height, over flat level ground, and at the instant the bullet emerges from the gun, you drop a second bullet from the same height, the two bullets will hit the ground at the same time. The forward motion of the fired bullet has no effect on its vertical motion.

The most common mistake that folks make in solving projectile motion problems is combining the x and y motion in one standard constant-acceleration equation. Don't do that. Treat the x-motion and the y-motion separately.

In solving projectile motion problems, we take advantage of the independence of the horizontal (x) motion and the vertical (y) motion by treating them separately. The one thing that is common to both the x motion and the y motion is the time. The key to the solution of many projectile motion problems is finding the total time of “flight.” For example, consider the following sample problem:

Example 13-1: A projectile is launched with a velocity of 11 m/s at an angle of 28° above the horizontal over flat level ground from a height of 2.0 m above ground level. How far forward does it go before hitting the ground? (Assume that air resistance is negligible.)

Before getting started, we better clearly establish what we are being asked to find. We define the forward direction as the x direction so what we are looking for is a value of x . More specifically, we are looking for the distance, measured along the ground, from that point on the ground directly below the point at which the projectile leaves the launcher, to the point on the ground where the projectile hits. This distance is known as the range of the projectile. It is also known as the range of the launcher for the given angle of launch and the downrange distance traveled by the projectile.

Okay, now that we know what we're solving for, let's get started. An initial velocity of 11 m/s at 28° above the horizontal, eh? Uh oh! We've got a dilemma. The key to solving projectile motion problems is to treat the x motion and the y motion separately. But we are given an initial velocity \vec{v}_0 which is a mix of the two of them. We have no choice but to break up the initial velocity into its x and y components.

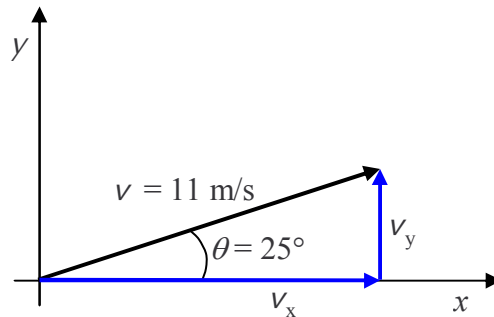

$\frac{v_x}{v} = \cos \theta$	$\frac{v_y}{v} = \sin \theta$
$v_x = v \cos \theta$	$v_y = v \sin \theta$
$v_x = 11 \frac{\text{m}}{\text{s}} \cos 25^\circ$	$v_y = 11 \frac{\text{m}}{\text{s}} \sin 25^\circ$
$v_x = 9.97 \frac{\text{m}}{\text{s}}$	$v_y = 4.65 \frac{\text{m}}{\text{s}}$

Now we're ready to get started. We'll begin with a sketch which defines our coordinate system, thus establishing the origin and the positive directions for x and y .

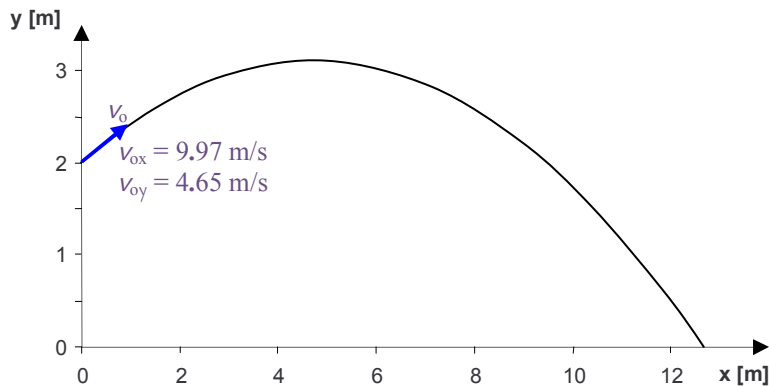

Recall that in projectile motion problems, we treat the x and y motion separately. Let's start with the x motion. It is the easier part because there is no acceleration.

x motion

$$x = \overset{0}{x_0} + v_{0x} t + \frac{1}{2} \overset{0}{a_x} t^2$$

$$x = v_{0x} t \quad (13-1)$$

Note that for the x -motion, we start with the constant acceleration equation that gives the position as a function of time. (Imagine having started a stopwatch at the instant the projectile lost contact with the launcher. The time variable t represents the stopwatch reading.) As you can see, because the acceleration in the x direction is zero, the equation quickly simplifies to $x = v_{0x} t$. We are “stuck” here because we have *two* unknowns, x and t , and only *one* equation. It's time to turn to the y motion.

It should be evident that it is the y motion that yields the time, the projectile starts off at a known elevation ($y = 2.0$ m) and the projectile motion ends when the projectile reaches another known elevation, namely, $y = 0$.

y-motion

$$y = y_0 + v_{0y} t + \frac{1}{2} a_y t^2 \quad (13-2)$$

This equation tells us that the y value at any time t is the initial y value plus some other terms that depend on t . It's valid for any time t , starting at the launch time $t = 0$, while the object is in projectile motion. In particular, it is applicable to that special time t , the last instant before the object makes contact with the ground, that instant that we are most interested in, the time when $y = 0$. What we can do, is to plug 0 in for y , and solve for that special time t that, when plugged into equation 13-2, makes y be 0. When we rewrite equation 13-2 with y set to 0, the symbol t takes on a new meaning. Instead of being a variable, it becomes a special time, the time that makes the y in the actual equation 13-2 ($y = y_0 + v_{0y} t + \frac{1}{2} a_y t^2$) zero.

$$0 = y_0 + v_{oy} t_* + \frac{1}{2} a_y t_*^2 \quad (13-3)$$

To emphasize that the time in equation 13-3 is a particular instant in time rather than the variable time since launch, I have written it as t_* to be read “ t star.” Everything in equation 13-3 is a given except t_* so we can solve equation 13-3 for t_* . Recognizing that equation 13-3 is a quadratic equation in t_* we first rewrite it in the form of the standard quadratic equation $ax + bx^2 + c = 0$. This yields:

$$\frac{1}{2} a_y t_*^2 + v_{oy} t_* + y_0 = 0$$

Then we use the quadratic formula $x = \frac{-b \pm \sqrt{b^2 - 4ac}}{2a}$ which for the case at hand appears as:

$$t_* = \frac{-v_{oy} \pm \sqrt{v_{oy}^2 - 4\left(\frac{1}{2} a_y\right) y_0}}{2\left(\frac{1}{2} a_y\right)}$$

which simplifies to

$$t_* = \frac{-v_{oy} \pm \sqrt{v_{oy}^2 - 2a_y y_0}}{a_y}$$

Substituting values with units yields:

$$t_* = \frac{-4.65 \frac{\text{m}}{\text{s}} \pm \sqrt{\left(4.65 \frac{\text{m}}{\text{s}}\right)^2 - 2\left(-9.80 \frac{\text{m}}{\text{s}^2}\right) 2.0 \text{ m}}}{-9.80 \frac{\text{m}}{\text{s}^2}}$$

which evaluates to

$$t_* = -0.321 \text{ s} \quad \text{and} \quad t_* = 1.27 \text{ s}$$

We discard the negative answer because we know that the projectile hits the ground after the launch, not before the launch.

Recall that t_* is the stopwatch reading when the projectile hits the ground. Note that the whole time it has been moving up and down, the projectile has been moving forward in accord with

equation 13-1, $x = v_{\text{ox}} t$. At this point, all we have to do is plug $t_* = 1.27 \text{ s}$ into equation 13-1 and evaluate:

$$x = v_{\text{ox}} t_*$$

$$x = 9.97 \frac{\text{m}}{\text{s}} (1.27 \text{ s})$$

$$x = 13 \text{ m}$$

This is the answer. The projectile travels 13 m forward before it hits the ground.

14 Newton's Laws #1: Using Free Body Diagrams

If you throw a rock upward in the presence of another person, and you ask that other person what keeps the rock going upward, after it leaves your hand but before it reaches its greatest height, that person may incorrectly tell you that the force of the person's hand keeps it going. This illustrates the common misconception that force is something that is given to the rock by the hand and that the rock "has" while it is in the air. It is not. A force is all about something that is being done to an object. We have defined a force to be an ongoing push or a pull. It is something that an object can be a victim to, it is never something that an object has. While the force is acting on the object, the motion of the object is consistent with the fact that the force is acting on the object. Once the force is no longer acting on the object, there is no such force, and the motion of the object is consistent with the fact that the force is absent. (As revealed in this chapter, the correct answer to the question about what keeps the rock going upward, is, "Nothing." Continuing to go upward is what it does all by itself if it is already going upward. You don't need anything to make it keep doing that. In fact, the only reason the rock does not continue to go upward forever is because there is a downward force on it. When there is a downward force and only a downward force on an object, that object is experiencing a downward acceleration. This means that the upward-moving rock slows down, then reverses its direction of motion and moves downward ever faster.)

Imagine that the stars are fixed in space so that the distance between one star and another never changes. (They are not fixed. The stars are moving relative to each other.) Now imagine that you create a Cartesian coordinate system; a set of three mutually orthogonal axes that you label x , y , and z . Your Cartesian coordinate system is a reference frame. Now as long as your reference frame is not rotating and is either fixed or moving at a constant velocity relative to the (fictitious) fixed stars, then your reference frame is an *inertial reference frame*. Note that velocity has both magnitude and direction and when we stipulate that the velocity of your reference frame must be constant in order for it to be an inertial reference frame, we aren't just saying that the magnitude has to be constant but that the direction has to be constant as well. The magnitude of the velocity is the speed. So, for the magnitude of the velocity to be constant, the speed must be constant. For the direction to be constant, the reference frame must move along a straight line path. So an inertial reference frame is one that is either fixed or moving at a constant speed along a straight line path, relative to the (fictitious) fixed stars.

The concept of an inertial reference frame is important in the study of physics because it is in inertial reference frames that the laws of motion known as Newton's Laws of Motion apply. Here are Newton's three laws of motion, observed to be adhered to by any particle of matter in an inertial reference frame:

- I. If there is no net force acting on a particle, then the velocity of that particle is not changing.**
- II. If there is a net force on a particle, then that particle is experiencing an acceleration that is directly proportional to the force, with the constant of proportionality being the reciprocal of the mass of the particle.**

III. Anytime one object is exerting a force on a second object, the second object is exerting an equal but opposite force back on the first object.

Discussion of Newton's 1st Law

Despite the name, it was actually Galileo that came up with the first law. He let a ball roll down a ramp with another ramp facing the other way in front of it so that, after it rolled down one ramp, the ball would roll up the other. He noted that the ball rolled up the second ramp, slowing steadily until it reached the same elevation as the one from which the ball was originally released from rest. He then repeatedly reduced the angle that the second ramp made with the horizontal and released the ball from rest from the original position for each new inclination of the second ramp. The smaller the angle, the more slowly the speed of the ball was reduced on the way up the second ramp and the farther it had to travel along the surface of the second ramp before arriving at its starting elevation. When he finally set the angle to zero, the ball did not appear to slow down at all on the second ramp. He didn't have an infinitely long ramp, but he induced that if he did, with the second ramp horizontal, the ball would keep on rolling forever, never slowing down because no matter how far it rolled, it would never gain any elevation, so it would never get up to the starting elevation. His conclusion was that if an object was moving, then if nothing interfered with its motion it would keep on moving at the same speed in the same direction. So what keeps it going? The answer is "nothing." That is the whole point. An object doesn't need anything to keep it going. If it is already moving, going at a constant velocity is what it does as long as there is no net force acting on it. In fact, it takes a *force* to *change* the velocity of an object.

It's not hard to see why it took a huge chunk of human history for someone to realize that if there is no net force on a moving object, it will keep moving at a constant velocity, because the thing is, where we live, on the surface of the Earth, there is inevitably a net force on a moving object. You throw something up and the Earth pulls downward on it the whole time the object is in flight. It's not going to keep traveling in a straight line upward, not with the Earth pulling on it. Even if you try sliding something across the smooth surface of a frozen pond where the downward pull of the Earth's gravitational field is cancelled by the ice pressing up on the object, you find that the object slows down because of a frictional force pushing on the object in the direction opposite that of the object's velocity and indeed a force of air resistance doing the same thing. In the presence of these ubiquitous forces, it took humankind a long time to realize that if there were no forces, an object in motion would stay in motion along a straight line path, at constant speed, and that an object at rest would stay at rest.

Discussion of Newton's 2nd Law

Galileo induced something else of interest from his ball-on-the-ramp experiments by focusing his attention on the first ramp discussed above. Observation of a ball released from rest revealed to him that the ball steadily sped up on the way down the ramp. Try it. As long as you don't make the ramp too steep, you can *see* that the ball doesn't just roll down the ramp at some fixed speed,

it accelerates the whole way down. Galileo further noted that the steeper the ramp was, the faster the ball would speed up on the way down. He did trial after trial, starting with a slightly inclined plane and gradually making it steeper and steeper. Each time he made it steeper, the ball would, on the way down the ramp, speed up faster than it did before, until the ramp got so steep that he could no longer see that it was speeding up on the way down the ramp—it was simply happening too fast to be observed. But Galileo induced that, as he continued to make the ramp steeper, the same thing was happening. That is that the ball's speed was still increasing on its way down the ramp and the greater the angle, the faster the ball would speed up. In fact, he induced that if he increased the steepness to the ultimate angle, 90° , that the ball would speed up the whole way down the ramp faster than it would at any smaller angle but that it would still speed up on the way down. Now, when the ramp is tilted at 90° , the ball is actually falling as opposed to rolling down the ramp, so Galileo's conclusion was that when you drop an object (for which air resistance is negligible), what happens is that the object speeds up the whole way down, until it hits the Earth.

Galileo thus did quite a bit to set the stage for Sir Isaac Newton, who was born the same year that Galileo died.

It was Newton who recognized the relationship between force and motion. He is the one that realized that the link was between force and acceleration, more specifically, that whenever an object is experiencing a net force, that object is experiencing an acceleration in the same direction as the force. Now, some objects are more sensitive to force than other objects—we can say that every object comes with its own sensitivity factor such that the greater the sensitivity factor, the greater the acceleration of the object for a given force. The sensitivity factor is the reciprocal of the mass of the object, so we can write that

$$\bar{a} = \frac{1}{m} \sum \bar{F} \quad (14-1)$$

where \bar{a} is the acceleration of the object, m is the mass of the object, and $\sum \bar{F}$ is the vector sum of all the forces acting on the object, that is to say that $\sum \bar{F}$ is the net force acting on the object.

Discussion of Newton's Third Law

In realizing that whenever one object is in the act of exerting a force on a second object, the second object is always in the act of exerting an equal and opposite force back on the first object, Newton was recognizing an aspect of nature that, on the surface, seems quite simple and straightforward, but quickly leads to conclusions that, however correct they may be, and indeed they are correct, are quite counterintuitive. Newton's 3rd law is a statement of the fact that any force whatsoever is just one half of an interaction where an *interaction* in this sense is the mutual pushing or pulling that quite often occurs when one object is in the vicinity of another.

In some cases, where the effect is obvious, the validity of Newton's third law is fairly evident. For instance if two people who have the same mass are on roller skates and are facing each other and one pushes the other, we see that both skaters go rolling backward, away from each other. It might at first be hard to accept the fact that the second skater is pushing back on the hands of the first skater, but we can tell that the skater that we think of as the pusher, must also be a "pushee," because we can see that she experiences a backward acceleration. In fact, while the pushing is taking place, the force exerted on her must be just as great as the force she exerts on the other skater because we see that her final backward speed is just as great as that of the other (same-mass) skater.

But how about those cases where the effect of at least one of the forces in the interaction pair is not at all evident? Suppose for instance that you have a broom leaning up against a slippery wall. Aside from our knowledge of Newton's laws, how can we convince ourselves that the broom is pressing against the wall, that is, that the broom is continually exerting a force on the wall; and; how can we convince ourselves that the wall is exerting a force back on the broom? One way to convince yourself is to let your hand play the role of the wall. Move the broom and put your hand in the place of the wall so that the broom is leaning against the palm of your hand at the same angle that it was against the wall with the palm of your hand facing directly toward the tip of the handle. You can feel the tip of the handle pressing against the palm of your hand. In fact, you can see the indentation that the tip of the broom handle makes in your hand. You can feel the force of the broom handle on your hand and you can induce that when the wall is where your hand is, relative to the broom, the broom handle must be pressing on the wall with the same force.

How about this business of the wall exerting a force on (pushing on) the tip of the broom handle? Again, with your hand playing the role of the wall, quickly move your hand out of the way. The broom, of course, falls down. Before moving your hand, you must have been applying a force on the broom or else the broom would have fallen down then. You might argue that your hand wasn't necessarily applying a force but rather that your hand was just "in the way." Well I'm here to tell you that "being in the way" is all about applying a force. When the broom is leaning up against the wall, the fact that the broom does not fall over means that the wall is exerting a force on the broom that cancels the other forces so that they don't make the broom fall over. In fact, if the wall was not strong enough to exert such a force, the wall would break. Still, it would be nice to get a visceral sense of the force exerted on the broom by the wall. Let your hand play the role of the wall, but this time, let the broom lean against your pinky, near the tip of your finger. To keep the broom in the same orientation as it was when it was leaning against the wall, you can feel that you have to exert a force on the tip of the broom handle. In fact, if you increase this force a little bit, the broom handle tilts more upward, and if you decrease it, it tilts more downward. Again, you can feel that you are pushing on the tip of the broom handle when you are causing the broom handle to remain stationary at the same orientation it had when it was leaning against the wall, and you can induce that when the wall is where your hand is, relative to the broom, the wall must be pressing on the broom handle with the same force. Note that the direction in which the wall is pushing on the broom is away from the wall at right angles to the wall. Such a force is exerted on any object that is in contact with a solid surface. This contact force exerted by a solid surface on an object in contact with that surface is called a "normal

force” because the force is perpendicular to the surface and the word “normal” means perpendicular.

Using Free Body Diagrams

The key to the successful solution of a Newton's 2nd Law problem is to draw a good free body diagram of the object whose motion is under study and then to use that free body diagram to expand Newton's 2nd Law, that is, to replace the $\sum \vec{F}$ with an the actual term-by-term sum of the forces. Note that Newton's 2nd Law $\vec{a} = \frac{1}{m} \sum \vec{F}$ is a vector equation and hence, in the most general case (3 dimensions) is actually three scalar equations in one, one for each of the three possible mutually orthogonal directions in space. (A scalar is a number. Something that has magnitude only, as opposed to a vector which has magnitude and direction.) In your physics course, you will typically be dealing with forces that all lie in the same plane, and hence, you will typically get two equations from $\vec{a} = \frac{1}{m} \sum \vec{F}$.

Regarding the Free Body Diagrams: The hard part is creating them from a description of the physical process under consideration; the easy part is using them. In what little remains of this chapter, we will focus on the easy part: Given a Free Body Diagram, use it to find an unknown force or unknown forces, and/or use it to find the acceleration of the object.

For example, given the free body diagram

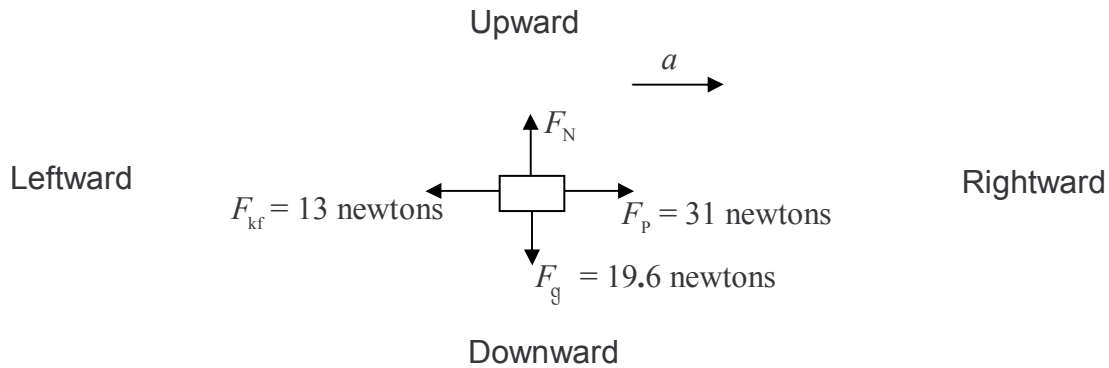

for an object of mass 2.00 kg, find the magnitude of the normal force F_N and find the magnitude of the acceleration a . (Note that we define the symbols that we use to represent the components of forces and the component of the acceleration, *in the free body diagram*. We do this by drawing an arrow whose shaft represents a line along which the force lies, and whose arrowhead we define to be the positive direction for that force component, and then labeling the arrow with our chosen symbol. A negative value for a symbol thus defined, simply means that the corresponding force or acceleration is in the direction opposite to the direction in which the arrow is pointing.

Solution: Note that the acceleration and all of the forces lie along one or the other of two imaginary lines (one of which is horizontal and the other of which is vertical) that are perpendicular to each other. The acceleration along one line is independent of any forces perpendicular to that line so we can consider one line at a time. Let's deal with the horizontal line first. We write Newton's 2nd Law for the horizontal line as

$$a_{\rightarrow} = \frac{1}{m} \sum F_{\rightarrow} \quad (14-2)$$

in which the shafts of the arrows indicate the line along which we are summing forces (the shafts in equation 14-2 are horizontal so we must be summing forces along the horizontal) and the arrowhead indicates which direction we consider to be the positive direction (any force in the opposite direction enters the sum with a minus sign).

The next step is to replace a_{\rightarrow} with the symbol that we have used in the diagram to represent the rightward acceleration and the $\sum F_{\rightarrow}$ with an actual term-by-term sum of the forces which includes only horizontal forces and in which rightward forces enter with a “+” and leftward forces enter with a “-”. This yields:

$$a = \frac{1}{m} (F_p - F_{kf})$$

Substituting values with units and evaluating gives:

$$a = \frac{1}{2.00 \text{ kg}} (31 \text{ N} - 13 \text{ N}) = 9.0 \frac{\text{m}}{\text{s}^2}$$

Now we turn our attention to the vertical direction. For your convenience, the free body diagram is replicated here:

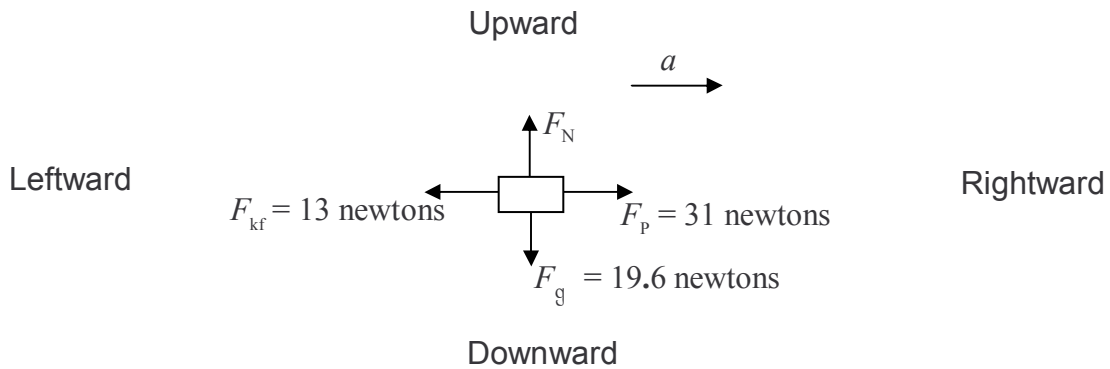

Again we start with Newton's 2nd Law, this time written for the vertical direction:

$$a_{\downarrow} = \frac{1}{m} \sum F_{\downarrow}$$

We replace a_{\downarrow} with what it is and we replace $\sum F_{\downarrow}$ with the term-by-term sum of the forces with a “+” for downward forces and a “-” for upward forces. Note that the only a in the free body diagram is horizontal. Whoever came up with that free body diagram is telling us that there is no acceleration in the vertical direction, that is, that $a_{\downarrow} = 0$. Thus:

$$0 = \frac{1}{m} (F_g - F_N)$$

Solving this for F_N yields

$$F_N = F_g$$

Substituting values with units results in a final answer of:

$$F_N = 19.6 \text{ newtons.}$$

15 Newton's Laws #2: Kinds of Forces, Creating Free Body Diagrams

There is no “force of motion” acting on an object. Once you have the force or forces exerted on the object by everything (including any force-per-mass field at the location of the object) that is touching the object, you have all the forces. Do not add a bogus “force of motion” to your free body diagram. It is especially tempting to add a bogus force when there are no actual forces in the direction in which an object is going. Keep in mind, however, that an object does not need a force on it to keep going in the direction in which it is going; moving along at a constant velocity is what an object does when there is no net force on it.

Now that you've had some practice using free body diagrams it is time to discuss how to create them. As you draw a free body diagram, there are a couple of things you need to keep in mind:

- (1) Include only those forces acting ON the object whose free body diagram you are drawing. Any force exerted BY the object on some other object belongs on the free body diagram of the *other* object.
- (2) All forces are contact forces and every force has an agent. The agent is “that which is exerting the force.” In other words, the agent is the life form or thing that is doing the pushing or pulling on the object. No agent can exert a force on an object without being in contact with the object. (We are using the field point of view, rather than the action-at-a-distance point of view for the fundamental forces of nature. Thus, for instance, it is the earth's gravitational field at the location of the object, rather than the material earth itself, that exerts the gravitational force on an object.)

We are going to introduce the various kinds of forces by means of examples. Here is the first example:

Example 15-1

A rock is thrown up into the air by a person. Draw the free body diagram of the rock while it is up in the air. (Your free body diagram is applicable for any time after the rock leaves the thrower's hand, until the last instant before the rock makes contact with whatever it is destined to hit.) Neglect any forces that might be exerted on the rock by the air.

If you see the rock flying through the air, it may very well look to you like there is nothing touching the rock. But the earth's gravitational field is everywhere in the vicinity of the earth. It can't be blocked. It can't be shielded. It is in the air, in the water, even in the dirt. It is in direct contact with everything in the vicinity of the earth. It exerts a force on every object near the surface of the earth. We call that force the gravitational force. You have already studied the gravitational force. We give a brief synopsis of it here.

The Gravitational Force Exerted on Objects Near the Surface of the Earth.

Because it has mass, the earth has a gravitational field. The gravitational field is a force-per-mass field. It is invisible. It is not matter. It is an infinite set of force-per-mass vectors, one at every point in space in the vicinity of the surface of the earth. Each force-per-mass vector is directed downward, toward the center of the earth and, near the surface of the earth, has a magnitude of $9.80 \frac{\text{N}}{\text{kg}}$. The symbol used to represent the earth's gravitational field vector at any point where it exists is \vec{g} . Thus,

$\vec{g} = 9.80 \frac{\text{N}}{\text{kg}}$ Downward. The effect of the earth's gravitational field is to exert a force on any object that is in the earth's gravitational field. The force is called the gravitational force and is equal to the product of the mass of the object and the earth's gravitational field vector: $\vec{F}_g = m\vec{g}$. The magnitude of the gravitational force is given by

$$F_g = mg \tag{15-1}$$

where $g = 9.80 \frac{\text{N}}{\text{kg}}$ is the magnitude of the earth's gravitational field vector. The direction of the near-earth's-surface gravitational force is downward, toward the center of the earth.

Here is the free body diagram and the corresponding table of forces for Example 15-1:

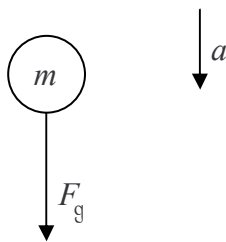

Table of Forces			
<i>Symbol = ?</i>	<i>Name</i>	<i>Agent</i>	<i>Victim</i>
$F_g = mg$	Gravitational Force	The Earth's Gravitational Field	The Rock

Note:

- 1) The only thing touching the object while it is up in the air (neglecting the air itself) is the earth's gravitational field. So there is only one force on the object, namely the gravitational force. The arrow representing the force vector is drawn so that the tail of the arrow is touching the object, and the arrow extends away from the object in the direction of the force.
- 2) Unless otherwise stipulated and labeled on the diagram, upward is toward the top of the page and downward is toward the bottom of the page.
- 3) The arrow representing the acceleration must be near but not touching the object. (If it is touching the object, one might mistake it for a force.)
- 4) There is no velocity information on a free body diagram.

- 5) There is no force of the hand acting on the object because, at the instant in question, the hand is no longer touching the object. When you draw a free body diagram, only forces that are acting on the object at the instant depicted in the diagram are included. The acceleration of the object depends only on the currently-acting forces on the object. The force of the hand is of historical interest only.
- 6) Regarding the table of forces:
- Make sure that for any free body diagram you draw, you are capable of making a complete table of forces. You are not required to provide a table of forces with every free body diagram you draw, but you should expect to be called upon to create a table of forces more than once.
 - In the table of forces, the agent is the life form or thing that is exerting the force and the victim is the object on which the force is being exerted. Make sure that, in every case, the victim is the object for which the free body diagram is being drawn.
 - In the case at hand, there is only one force so there is only one entry in the table of forces.
 - For any object near the surface of the earth, the agent of the gravitational force is the earth's gravitational field. It is okay to abbreviate that to "Earth" because the gravitational field of the earth can be considered to be an invisible part of the earth, but it is NOT okay to call it "gravity." Gravity is a subject heading corresponding to the kind of force the gravitational force is, gravity is not an agent.

Example 15-2

A ball of mass m hangs at rest, suspended by a string. Draw the free body diagram for the ball, and create the corresponding table of forces.

To do this problem, you need the following information about strings:

The Force Exerted by a Taut String on an Object to Which it is Affixed

(This also applies to ropes, cables, chains, and the like.)

The force exerted by a string, on an object to which it is attached, is always directed away from the object, along the length of the string.

Note that the force in question is exerted by the string, not for instance, by some person pulling on the other end of the string.

The force exerted by a string on an object is referred to as a "tension force" and its magnitude is conventionally represented by the symbol F_T .

Note: There is no formula to tell you what the tension force is. If it is not given, the only way to get it is to use Newton's 2nd Law.

Here is the free body diagram of the ball, and the corresponding table of forces for Example 15-2:

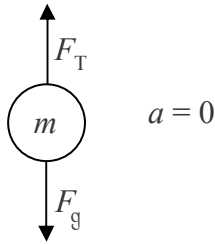

Table of Forces			
<i>Symbol=?</i>	<i>Name</i>	<i>Agent</i>	<i>Victim</i>
F_T	Tension Force	The String	The Ball
$F_g = mg$	Gravitational Force	The Earth's Gravitational Field	The Ball

Example 15-3

A sled of mass m is being pulled forward over a horizontal frictionless surface by means of a horizontal rope attached to the front of the sled. Draw the free body diagram of the sled and provide the corresponding table of forces.

Aside from the rope and the earth's gravitational field, the sled is in contact with a solid surface. The surface exerts a kind of force that we need to know about in order to create the free body diagram for this example.

The Normal Force

When an object is in contact with a surface, that surface exerts a force on the object. The surface presses on the object. The force on the object is away from the surface, and it is perpendicular to the surface. The force is called the normal force because "normal" means perpendicular, and as mentioned, the force is perpendicular to the surface. We use the symbol F_N to represent the magnitude of the normal force.

Note: There is no formula to tell you what the normal force is. If it is not given, the only way to get it is to use Newton's 2nd Law.

Here is the free body diagram of the sled as well as the corresponding table of forces.

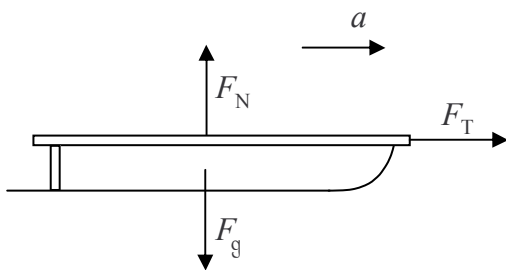

Table of Forces			
<i>Symbol=?</i>	<i>Name</i>	<i>Agent</i>	<i>Victim</i>
F_N	Normal Force	The Horizontal Surface	The Sled
F_T	Tension Force	The Rope	The Sled
$F_g = mg$	Gravitational Force	The Earth's Gravitational Field	The Sled

Note: The word “Free” in “Free Body Diagram” refers to the fact that the object is drawn free of its surroundings. Do not include the surroundings (such as the horizontal surface on which the sled is sliding in the case at hand) in your Free Body Diagram.

Example 15-4

A block of mass m rests on a frictionless horizontal surface. The block is due west of a west-facing wall. The block is attached to the wall by an ideal massless uncompressed/unstretched spring whose force constant is k . The spring is perpendicular to the wall. A person pulls the block a distance x directly away from the wall and releases it from rest. Draw the free body diagram of the block appropriate for the first instant after release. Provide the corresponding table of forces.

Now, for the first time, we have a spring exerting a force on the object for which we are drawing the free body diagram. So, we need to know about the force exerted by a spring.

The Force Exerted by a Spring

The force exerted by an ideal massless spring on an object in contact with one end of the spring is directed along the length of the spring, and

- away from the object if the spring is stretched,
- toward the object if the spring is compressed.

For the spring to exert a force on the object in the stretched-spring case, the object must be attached to the end of the spring. Not so in the compressed-spring case. The spring can push on an object whether or not the spring is attached to the object.

The force depends on the amount $|x|$ by which the spring is stretched or compressed, and on a measure of the stiffness of the spring known as the force constant of the spring a.k.a. the spring constant and represented by the symbol k . The magnitude of the spring force is typically represented by the symbol F_s . The spring force is directly proportional to the amount of stretch $|x|$. The spring constant k is the constant of proportionality.

Thus,

$$F_s = k|x| \quad (15-2)$$

Here is the free body diagram of the block, and the corresponding table of forces for Example 15-4:

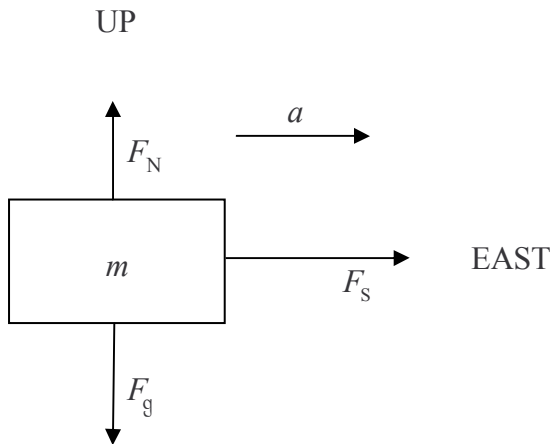

*BEWARE: By chance, in the examples provided in this chapter, the normal force is upward. Never assume it to be upward. The normal force is perpendicular to, and away from, the surface exerting it. It happens to be upward in the examples because the object is in contact with the top of a horizontal surface. If the surface is a wall, the normal force is horizontal; if it is a ceiling, downward; if an incline, perpendicular to and away from the incline. **Never assume the normal force to be upward.***

Table of Forces			
<i>Symbol=?</i>	<i>Name</i>	<i>Agent</i>	<i>Victim</i>
F_N	Normal Force	The Horizontal Surface	The Block
$F_s = k x $	Spring Force	The Spring	The Block
$F_g = mg$	Gravitational Force	The Earth's Gravitational Field	The Block

Example 15-5

From your vantage point, a crate of mass m is sliding rightward on a flat level concrete floor. Nothing solid is in contact with the crate except for the floor. Draw the free body diagram of the crate. Provide the corresponding table of forces.

From our experience with objects sliding on concrete floors, we know that the crate is slowing down at the instant under consideration. It is slowing because of kinetic friction.

Kinetic Friction

A surface, upon which an object is sliding, exerts (in addition to the normal force) a retarding force on that object. The retarding force is in the direction opposite that of the velocity of the object. In the case of an object sliding on a dry surface of a solid body (such as a floor) we call the retarding force a kinetic frictional force. Kinetic means motion and we include the adjective kinetic to make it clear that we are dealing with an object that is in motion.

The kinetic frictional formula given below is an empirical result. This means that it is

derived directly from experimental results. It works only in the case of objects sliding on dry surfaces. It does not apply, for instance, to the case of an object sliding on a greased surface.

We use the symbol F_{kf} for the kinetic friction force. The kinetic frictional formula reads

$$F_{kf} = \mu_K F_N \quad (15-3)$$

F_N is the magnitude of the normal force. Its presence in the formula indicates that the more strongly the surface is pressing on the object, the greater the frictional force.

μ_K (mu-sub-K) is called the coefficient of kinetic friction. Its value depends on the materials of which both the object and the surface are made as well as the smoothness of the two contact surfaces. It has no units. It is just a number. The magnitude of the kinetic frictional force is some fraction of the magnitude of the normal force; μ_K is that fraction. Values of μ_K for various pairs of materials can be found in handbooks. They tend to fall between 0 and 1. The actual value for a given pair of materials depends on the smoothness of the surface and is typically quoted with but a single significant digit.

IMPORTANT: μ_K is a coefficient (with no units) used in calculating the frictional force. It is not a force itself.

Here is the free body diagram and the table of forces for the case at hand. The crate is moving rightward and slowing down—it has a leftward acceleration.

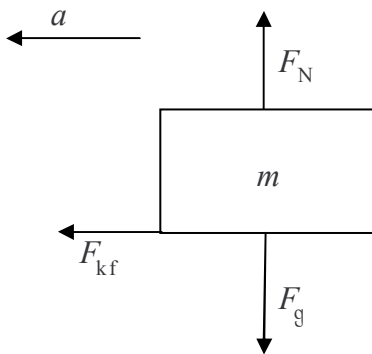

Table of Forces			
Symbol	Name	Agent	Victim
F_N	Normal Force	The Concrete Floor	The Crate
$F_{kf} = \mu_K F_N$	Kinetic Friction Force	The Concrete Floor	The Crate
$F_g = mg$	Gravitational Force	The Earth's Gravitational Field	The Crate

Note: Not every object has a normal (“perpendicular-to-the-surface”) force acting on it. If the object is not in contact with a surface, then there is no normal force acting on the object.

Example 15-6

A person has pushed a brick along a tile floor toward an eastward-facing wall trapping a spring of unstretched length L_0 and force constant k between the wall and the end of the brick that is facing the wall. That end of the brick is a distance d from the wall. The person has released the brick, but the spring is unable to budge it—the brick remains exactly where it was when the person released it. Draw the free body diagram for the brick and provide the corresponding table of forces.

A frictional force is acting on an object at rest. Typically, an object *at rest* clings more strongly to the surface with which it is in contact than the same object does when it is *sliding* across the same surface. What we have here is a case of static friction.

Static Friction Force

A surface that is not frictionless can exert a static friction force on an object that is in contact with that surface. The force of static friction is parallel to the surface. It is in the direction opposite the direction of impending motion of the stationary object. The direction of impending motion is the direction in which the object would accelerate if there was no static friction.

In general, there is no formula for calculating static friction—to solve for the force of static friction, you use Newton's 2nd Law. The force of static friction is whatever it has to be to make the net parallel-to-the-surface force zero.

We use the symbol F_{sf} to represent the magnitude of the static friction force.

SPECIAL CASE: Imagine trying to push a refrigerator across the floor. Imagine that you push horizontally, and that you gradually increase the force with which you are pushing. Initially, the harder you push, the bigger the force of static friction. But it can't grow forever. There is a maximum possible static friction force magnitude for any such case. Once the magnitude of your force exceeds that, the refrigerator will start sliding. The maximum possible force of static friction is given by:

$$F_{sf}^{\text{max possible}} = \mu_s F_N \quad (15-4)$$

The unitless quantity μ_s is the coefficient of static friction specific to the type of surface the object is sliding on and the nature of the surface of the object.

Values of μ_s tend to fall between 0 and 1. For a particular pair of surfaces, μ_s is at least as large as, and typically larger than, μ_k .

Clearly, this formula ($F_{sf}^{\text{max possible}} = \mu_s F_N$) is only applicable when the question is about the maximum possible force of static friction. You can use this formula if the object is said to be on the verge of slipping, or if the question is about how hard one must push to budge an object. It also comes in handy when you want to know whether or not an object will stay put. In such a case you would use Newton's 2nd to find out the magnitude of the force of static friction needed to keep the object from accelerating. Then you would compare that magnitude with the maximum possible magnitude of the force of static friction.

Here is the free body diagram of the brick and the table of forces for Example 15-6:

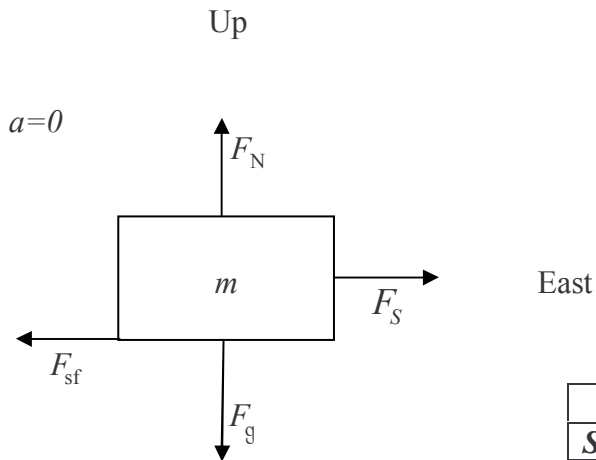

Table of Forces			
<i>Symbol=?</i>	<i>Name</i>	<i>Agent</i>	<i>Victim</i>
F_N	Normal Force	The Tile Floor	The Brick
F_{sf}	Static Friction Force	The Tile Floor	The Brick
$F_g = mg$	Gravitational Force	The Earth's Gravitational Field	The Brick
$F_s = k x $	Spring Force	The Spring	The Brick

16 Newton's Laws #3: Components, Friction, Ramps, Pulleys, and Strings

When, in the case of a tilted coordinate system, you break up the gravitational force vector into its component vectors, make sure the gravitational force vector itself forms the hypotenuse of the right triangle in your vector component diagram. All too often, folks draw one of the components of the gravitational force vector in such a manner that it is bigger than the gravitational force vector it is supposed to be a component of. The component of a vector is never bigger than the vector itself.

Having learned how to use free body diagrams, and then having learned how to create them, you are in a pretty good position to solve a huge number of Newton's 2nd Law problems. An understanding of the considerations in this chapter will enable you to solve an even larger class of problems. Again, we use examples to convey the desired information.

Example 16-1

A professor is pushing on a desk with a force of magnitude F at an acute angle θ below the horizontal. The desk is on a flat, horizontal tile floor and it is not moving. For the desk, draw the free body diagram that facilitates the direct and straightforward application of Newton's 2nd Law of motion. Give the table of forces.

While not a required part of the solution, a sketch often makes it easier to come up with the correct free body diagram. Just make sure you don't combine the sketch and the free body diagram. In this problem, a sketch helps clarify what is meant by "at an acute angle θ below the horizontal."

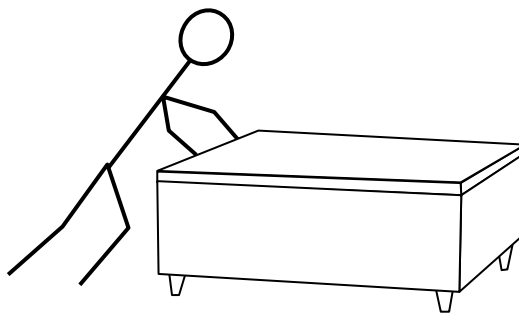

Pushing with a force that is directed at some acute angle below the horizontal is pushing horizontally and downward at the same time.

Here is the initial free body diagram and the corresponding table of forces.

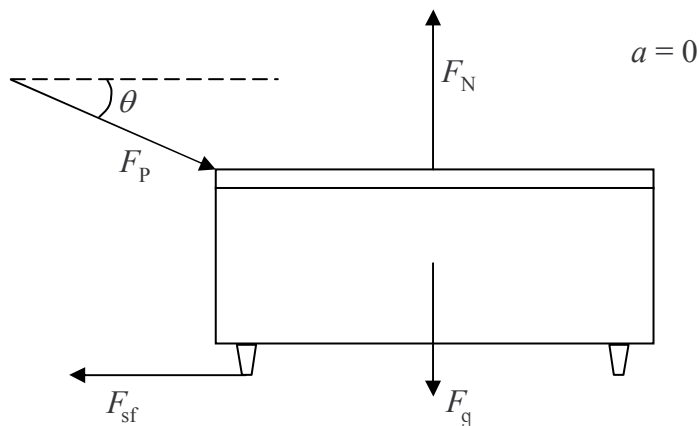

Table of Forces

<i>Symbol=?</i>	<i>Name</i>	<i>Agent</i>	<i>Victim</i>
F_N	Normal Force	The Floor	Desk
F_{sf}	Static Friction Force	The Floor	Desk
$F_g = mg$	Gravitational Force	The Earth's Gravitational Field	Desk
F_P	Force of Professor	Hands of Professor	Desk

Note that there are no two mutually perpendicular lines to which all of the forces are parallel. The best choice of mutually perpendicular lines would be a vertical and a horizontal line. Three of the four forces lie along one or the other of such lines. But the force of the professor does not. We cannot use this free body diagram directly. We are dealing with a case which requires a second free body diagram.

Cases Requiring a Second Free Body Diagram in Which One of More of the Forces that was in the First Free Body Diagram is Replaced With its Components

Establish a pair of mutually perpendicular lines such that most of the vectors lie along one or the other of the two lines. After having done so, break up each of the other vectors, the ones that lie along neither of the lines, (let's call these the rogue vectors) into components along the two lines. (Breaking up vectors into their components involves drawing a vector component diagram.) Draw a second free body diagram, identical to the first, except with rogue vectors replaced by their component vectors. In the new free body diagram, draw the component vectors in the direction in which they actually point and label them with their magnitudes (no minus signs).

For the case at hand, our rogue force is the force of the professor. We break it up into components as follows:

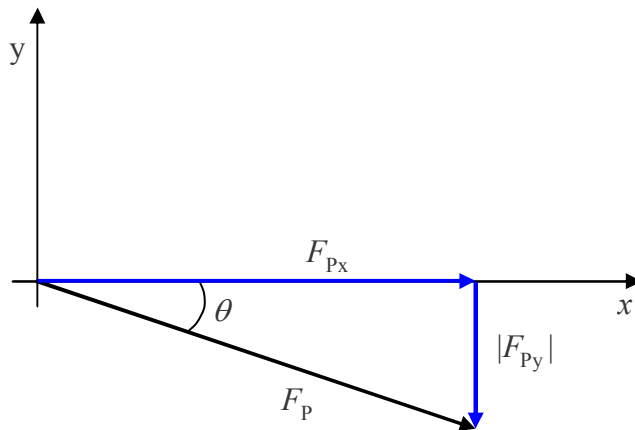

$\frac{F_{px}}{F_p} = \cos \theta$	$\frac{ F_{py} }{F_p} = \sin \theta$
$F_{px} = F_p \cos \theta$	$ F_{py} = F_p \sin \theta$

Then we draw a second free body diagram, the same as the first, except with F_p replaced by its component vectors:

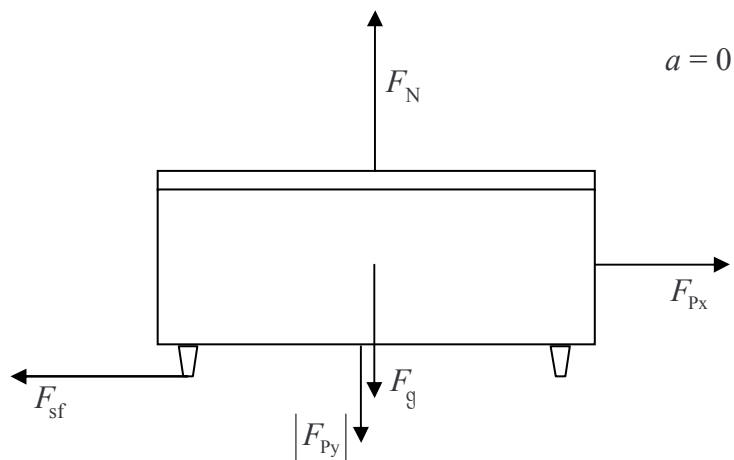

Example 16-2

A wooden block of mass m is sliding down a flat metal incline (a flat metal ramp) that makes an acute angle θ with the horizontal. The block is slowing down. Draw the directly-usable free body diagram of the block. Provide a table of forces.

We choose to start the solution to this problem with a sketch. The sketch facilitates the creation of the free body diagram but in no way replaces it.

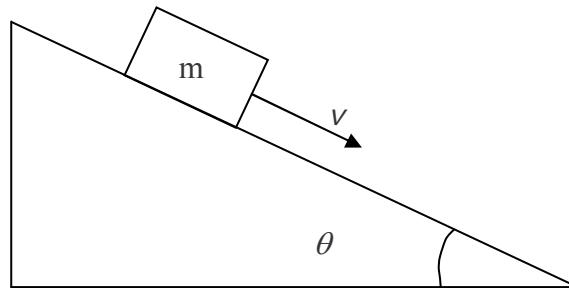

Since the block is sliding in the down-the-incline direction, the frictional force must be in the up-the-incline direction. Since the block's velocity is in the down-the-incline direction and decreasing, the acceleration must be in the up-the-incline direction.

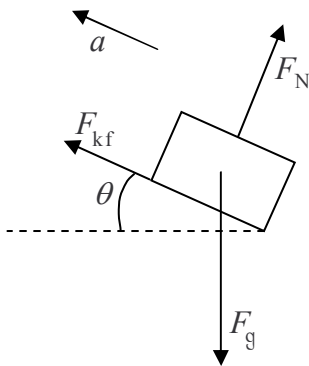

Table of Forces			
<i>Symbol=?</i>	<i>Name</i>	<i>Agent</i>	<i>Victim</i>
F_N	Normal Force	The Ramp	The Block
$F_{kf} = \mu_k F_N$	Kinetic Friction Force	The Ramp	The Block
$F_g = mg$	Gravitational Force	The Earth's Gravitational Field	The Block

No matter what we choose for a pair of coordinate axes, we cannot make it so that all the vectors in the free body diagram are parallel to one or the other of the two coordinate axes lines. At best, the pair of lines, one line parallel to the frictional force and the other perpendicular to the ramp, leaves one rogue vector, namely the gravitational force vector. Such a coordinate system is tilted on the page.

Cases Involving Tilted Coordinate Systems

For effective communication purposes, students drawing diagrams depicting phenomena occurring near the surface of the earth are required to use either the convention that downward is toward the bottom of the page (corresponding to a side view) or the convention that downward is into the page (corresponding to a top view). If one wants to depict a coordinate system for a case in which the direction “downward” is parallel to neither coordinate axis line, the coordinate system must be drawn so that it appears tilted on the page.

In the case of a tilted-coordinate system problem requiring a second free body diagram of the same object, it is a good idea to define the coordinate system on the first free body diagram. Use dashed lines so that the coordinate axes do not look like force vectors. Here we redraw the first free body diagram. (When *you* get to this stage in a problem, just add the coordinate axes to your existing diagram.)

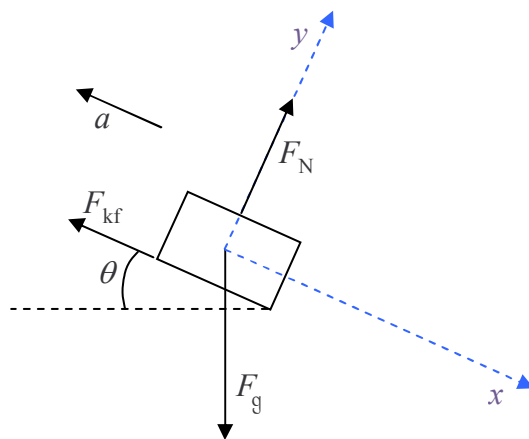

Now we break up \vec{F}_g into its x, y component vectors. This calls for a vector component diagram.

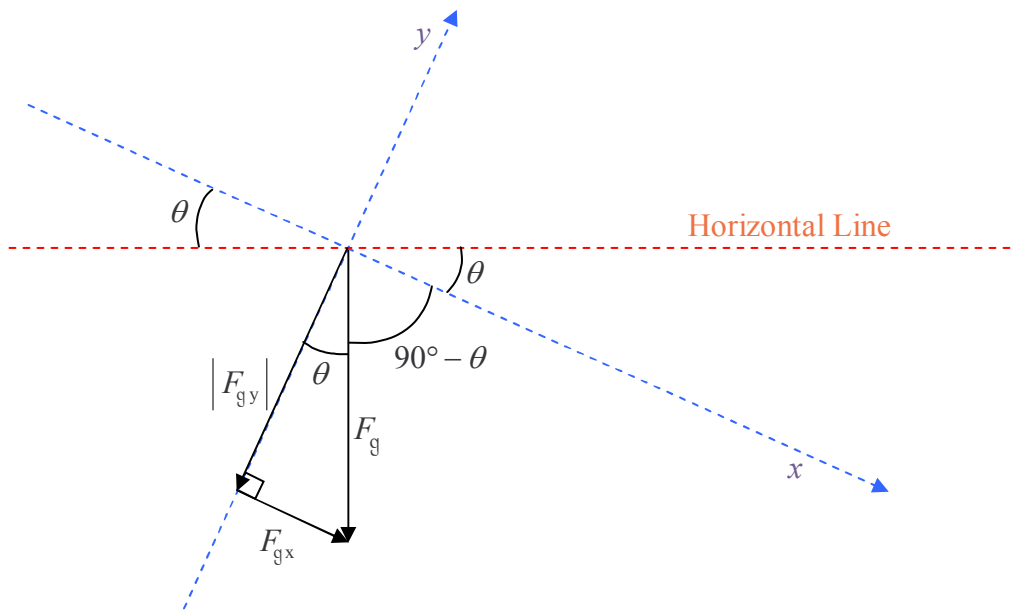

$\frac{F_{gx}}{F_g} = \sin\theta$	$\frac{ F_{gy} }{F_g} = \cos\theta$
$F_{gx} = F_g \sin\theta$	$ F_{gy} = F_g \cos\theta$

Next, we redraw the free body diagram with the gravitational force vector replaced by its component vectors.

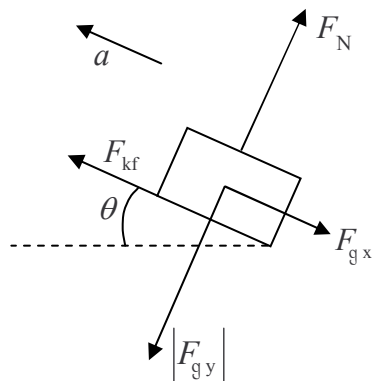

Example 16-3

A solid brass cylinder of mass m is suspended by a massless string which is attached to the top end of the cylinder. From there, the string extends straight upward to a massless ideal pulley. The string passes over the pulley and extends downward, at an acute angle θ to the vertical, to the hand of a person who is pulling on the string with force F_T . The pulley and the entire string segment, from the cylinder to hand, lie in one and the same plane. The cylinder is accelerating upward. Provide both a free body diagram and a table of forces for the cylinder.

A sketch comes in handy for this one:

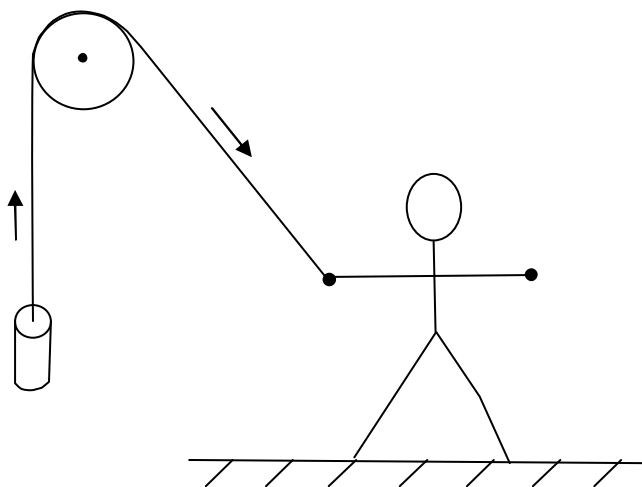

To proceed with this one, we need some information on the effect of an ideal massless pulley on a string that passes over the pulley.

<p>Effect of an Ideal Massless Pulley</p> <p>The effect of an ideal massless pulley on a string that passes over the pulley is to change the direction in which the string extends, without changing the tension in the string.</p>
--

By pulling on the end of the string with a force of magnitude F_T , the person causes there to be a tension F_T in the string. (The force applied to the string by the hand of the person, and the tension force of the string pulling on the hand of the person, are a Newton's-3rd-law interaction pair of forces. They are equal in magnitude and opposite in direction. We choose to use one and the same symbol F_T for the magnitude of both of these forces. The directions are opposite each other.) The tension is the same throughout the string, so, where the string is attached to the brass cylinder, the string exerts a force of magnitude F_T directed away from the cylinder along the length of the string. Here is the free body diagram and the table of forces for the cylinder:

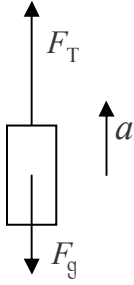
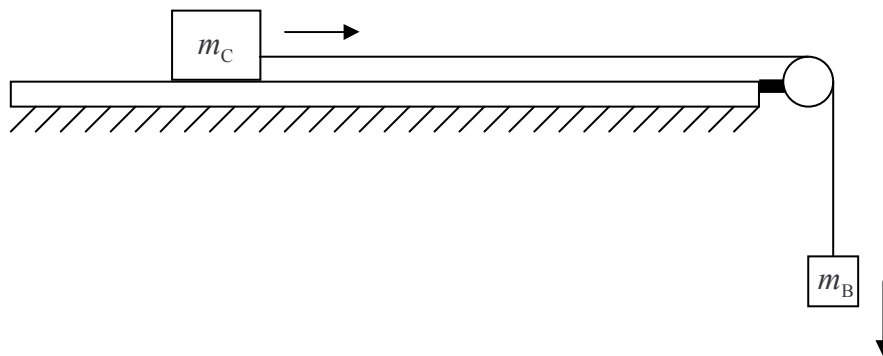

Table of Forces			
Symbol=?	Name	Agent	Victim
F_T	Tension Force	The String	The Cylinder
$F_g = mg$	Gravitational Force	The Earth's Gravitational Field	The Cylinder

Example 16-4

A cart of mass m_C is on a horizontal frictionless track. One end of an ideal massless string segment is attached to the middle of the front end of the cart. From there the string extends horizontally, forward and away from the cart, parallel to the centerline of the track, to a vertical pulley. The string passes over the pulley and extends downward to a solid metal block of mass m_B . The string is attached to the block. A person was holding the cart in place. The block was suspended at rest, well above the floor, by the string. The person has released the cart. The cart is now accelerating forward and the block is accelerating downward. Draw a free body diagram for each object.

A sketch will help us to arrive at the correct answer to this problem.



Recall from the last example that there is only one tension in the string. Call it F_T . Based on our knowledge of the force exerted on an object by a string, viewed so that the apparatus appears as it does in the sketch, the string exerts a rightward force F_T on the cart, and an upward force of magnitude F_T on the block.

There is a relationship between each of several variables of motion of one object attached by a taut string, which remains taut throughout the motion of the object, and the corresponding variables of motion of the second object. The relationships are so simple that you might consider them to be trivial, but they are critical to the solution of problems involving objects connected by a taut string.

The Relationships Among the Variables of Motion For Two Objects, One at One End and the Other at the Other End, of an always-taut, Unstretchable String

Consider the following diagram.

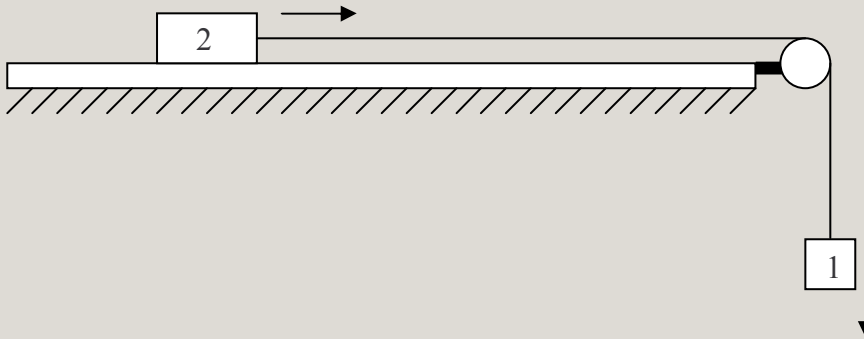

Because they are connected together by a string of fixed length, if object 1 goes downward 5 cm, then object 2 must go rightward 5 cm. So if object 1 goes downward at 5 cm/s then object 2 must go rightward at 5 cm/s. In fact, no matter how fast object 1 goes downward, object 2 must go rightward at the exact same speed (as long as the string does not break, stretch, or go slack). In order for the speeds to always be the same, the accelerations have to be the same as each other. So if object 1 is picking up speed in the downward direction at, for instance, 5 cm/s^2 , then object 2 must be picking up speed in the rightward direction at 5 cm/s^2 . The magnitudes of the accelerations are identical. The way to deal with this is to use one and the same symbol for the magnitude of the acceleration of each of the objects. The ideas relevant to this simple example apply to any case involving two objects, one on each end of an inextensible string, as long as each object moves only along a line collinear with the string segment to which the object is attached.

Let's return to the example problem involving the cart and the block. The two free body diagrams follow:

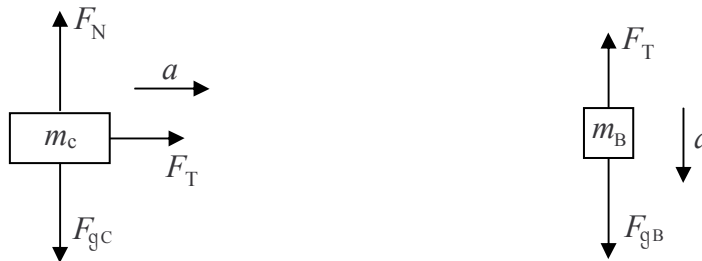

Note that the use of the same symbol F_T in both diagrams is important, as is the use of the same symbol a in both diagrams.

17 The Universal Law of Gravitation

Consider an object released from rest an entire moon's diameter above the surface of the moon. Suppose you are asked to calculate the speed with which the object hits the moon. This problem typifies the kind of problem in which students use the universal law of gravitation to get the force exerted on the object by the gravitational field of the moon, and then mistakenly use one or more of the constant acceleration equations to get the final velocity. The problem is: the acceleration is not constant. The closer the object gets to the moon, the greater the gravitational force, and hence, the greater the acceleration of the object. The mistake lies not in using Newton's second law to determine the acceleration of the object at a particular point in space; the mistake lies in using that one value of acceleration, good for one object-to-moon distance, as if it were valid on the entire path of the object. The way to go on a problem like this, is to use conservation of energy.

Back in chapter 12, where we discussed the near-surface gravitational field of the earth, we talked about the fact that any object that has mass creates an invisible force-per-mass field in the region of space around it. We called it a gravitational field. Here we talk about it in more detail. Recall that when we say that an object causes a gravitational field to exist, we mean that it creates an invisible force-per-mass vector at every point in the region of space around itself. The effect of the gravitational field on any particle (call it the victim) that finds itself in the region of space where the gravitational field exists, is to exert a force, on the victim, equal to the force-per-mass vector at the victim's location, times the mass of the victim.

Now we provide a quantitative discussion of the gravitational field. (*Quantitative* means, involving formulas, calculations, and perhaps numbers. Contrast this with *qualitative* which means descriptive/conceptual.) We start with the idealized notion of a point particle of matter. Being matter, it has mass. Since it has mass it has a gravitational field in the region around it. The direction of a particle's gravitational field at point P, a distance r away from the particle, is *toward the particle* and the magnitude of the gravitational field is given by

$$g = G \frac{m}{r^2} \quad (17-1)$$

where:

G is the universal gravitational constant: $G = 6.67 \times 10^{-11} \frac{\text{N} \cdot \text{m}^2}{\text{kg}^2}$

m is the mass of the particle, and

r is the distance that point P is from the particle.

In that point P can be any empty (or occupied) point in space whatsoever, this formula gives the magnitude of the gravitational field of the particle at all points in space. Equation 17-1 is the equation form of Newton's Universal Law of Gravitation¹.

¹ Newton's Universal Law of Gravitation is an approximation to Einstein's far more complicated General Theory of Relativity. The approximation is fantastic for orbital mechanics for space vehicles and most planets, but we need to use the General Theory of Relativity for a complete explanation of the orbit of Mercury.

The Total Gravitational Field Vector at an Empty Point in Space

Suppose that you have two particles. Each has its own gravitational field at all points in space. Let's consider a single empty point in space. Each of the two particles has its own gravitational field vector at that empty point in space. We can say that each particle makes its own vector contribution to the total gravitational field at the empty point in space in question. So how do you determine the total gravitational field at the empty point in space? You guessed it! Just add the individual contributions. And because the contribution due to each particle is a vector, the two contributions add like vectors².

What the Gravitational Field does to a Particle that is in the Gravitational Field

Now suppose that you have the magnitude and direction of the gravitational field vector \vec{g} at a particular point in space. The gravitational field exerts a force on any "victim" particle that happens to find itself at that location in space. Suppose, for instance, that a particle of mass m finds itself at a point in space where the gravitational field (of some other particle or particles) is \vec{g} . Then the particle of mass m is subject to a force

$$\vec{F}_G = m\vec{g} \quad (17-2)$$

The Gravitational Effect of one Particle on Another

Let's put the two preceding ideas together. Particle 1 of mass m_1 has, among its infinite set of gravitational field vectors, a gravitational field vector at a location a distance r_{12} away from itself, a point in space that happens to be occupied by another particle, particle 2, of mass m_2 . The gravitational field of particle 1 exerts a force on particle 2. The question is, how big and which way is the force?

Let's start by identifying the location of particle 2 as point P. Point P is a distance r_{12} away from particle 1. Thus, the magnitude of the gravitational field vector (of particle 1) at point P is:

$$g = G \frac{m_1}{r_{12}^2} \quad (17-3)$$

² The statement that the various contributions to the gravitational field add like vectors is known as the superposition principle for the gravitational field. Einstein, in his General Theory of Relativity, showed that the superposition principle for the gravitational field is actually an approximation that is excellent for the gravitational fields you will deal with in this course but breaks down in the case of very strong gravitational fields.

Now the force exerted on particle 2 by the gravitational field of particle 1 is given by equation 17-2, $\vec{F}_G = m_2 \vec{g}$. Using \vec{F}_{12} for \vec{F}_G to emphasize the fact that we are talking about the force of 1 on 2, and writing the equation relating the magnitudes of the vectors we have

$$F_{12} = m_2 g$$

Replacing the g with the expression we just found for the magnitude of the gravitational field due to particle number 1 we have

$$F_{12} = m_2 G \frac{m_1}{r_{12}^2}$$

which, with some minor reordering can be written as

$$F_{12} = G \frac{m_1 m_2}{r_{12}^2} \quad (17-4)$$

This equation gives the force of the gravitational field of particle 1 on particle 2. Neglecting the “middleman” (the gravitational field) we can think of this as the force of particle 1 on particle 2. You can go through the whole argument again, with the roles of the particles reversed, to find that the same expression applies to the force of particle 2 on particle 1, or you can simply invoke Newton’s 3rd Law to arrive at the same conclusion.

Objects, Rather than Point Particles

The vector sum of all the gravitational field vectors due to a spherically symmetric distribution of point particles (for instance, a spherically symmetric solid object), at a point outside the distribution (e.g. outside the object), is the same as the gravitational field vector due to a single particle, at the center of the distribution, whose mass is equal to the sum of the masses of all the particles. Also, for purposes of calculating the force exerted by the gravitational field of a point object on a spherically symmetric victim, one can treat the victim as a point object at the center of the victim. Finally, regarding either object in a calculation of the gravitational force exerted on a rigid object by the another object: if the separation of the objects is very large compared to the dimensions of the object, one can treat the object as a point particle located at the center of mass of the object and having the same mass as the object. This goes for the gravitational potential energy, discussed below, as well.

How Does this Fit in with $g = 9.80 \text{ N/kg}$?

When we talked about the earth's near-surface gravitational field before, we used a single value for its magnitude, namely 9.80 N/kg and said that it always directed downward, toward the center of the earth. 9.80 N/kg is actually an average sea level value. g varies within about a half a percent of that value over the surface of the earth and the handbook value includes a tiny centrifugal pseudo force-per-mass field contribution (affecting both magnitude and direction) stemming from the rotation of the earth. So how does the value 9.80 N/kg for the magnitude of the gravitational field near the surface of the earth relate to Newton's Universal Law of Gravitation?

Certainly the direction is consistent with our understanding of what it should be: The earth is roughly spherically symmetric so for purposes of calculating the gravitational field outside of the earth we can treat the earth as a point particle located at the center of the earth. The direction of the gravitational field of a point particle is toward that point particle, so, anywhere outside the earth, including at any point *just* outside the earth (near the surface of the earth), the gravitational field, according to the Universal Law of Gravitation, must be directed toward the center of the earth, a direction we earthlings call downward.

But how about the magnitude? Shouldn't it vary with elevation according to the Universal Law of Gravitation? First off, how does the magnitude calculated using $g = G \frac{m}{r^2}$ compare with 9.80 N/kg at, for instance, sea level. A point at sea level is a distance $r = 6.37 \times 10^6 \text{ m}$ from the center of the earth. The mass of the earth is $m = 5.98 \times 10^{24} \text{ kg}$. Substituting these values into our expression for g (equation 17-4 which reads $g = G \frac{m_1}{r_{12}^2}$) we find:

$$g = 6.67 \times 10^{-11} \frac{\text{N} \cdot \text{m}^2}{\text{kg}^2} \frac{5.98 \times 10^{24} \text{ kg}}{(6.37 \times 10^6 \text{ m})^2}$$

$$g = 9.83 \frac{\text{N}}{\text{kg}}$$

which does agree with the value of 9.80 N/kg to within about 0.3 percent. (The difference is due in part to the centrifugal pseudo force-per-mass field associated with the earth's rotation.) We can actually see, just from the way that the value of the radius of the earth, $6.37 \times 10^6 \text{ m}$, is written, that increasing our elevation, even by a mile (1.61 km), is not going to change the value of g to three significant figures. We'd be increasing r from $6.37 \times 10^6 \text{ m}$ to $6.37161 \times 10^6 \text{ m}$ which, to three significant figures is still $6.37 \times 10^6 \text{ m}$. This brings up the question, "How high above the surface do you have to go before $g = 9.80 \frac{\text{N}}{\text{kg}}$ is no longer within a certain percentage of the value obtained by means of the Universal Law of Gravitation?" Let's investigate that question for the case of a 1 percent difference. In other words, how high above sea level would

we have to go to make $g = 99\%$ of g at sea level, that is $g = (.99)(9.80 \text{ m/s}^2) = 9.70 \text{ m/s}^2$. Letting $r = r_E + h$ where r_E is the radius of the earth, and using $g = 9.70 \text{ N/kg}$ so that we can find the h that makes 9.70 N/kg we have:

$$g = \frac{Gm_E}{(r_E + h)^2}$$

Solving this for h yields

$$h = \sqrt{\frac{Gm_E}{g}} - r_E$$

$$h = \sqrt{\frac{6.67 \times 10^{-11} \frac{\text{N} \cdot \text{m}^2}{\text{kg}^2} 5.98 \times 10^{24} \text{ kg}}{9.70 \frac{\text{N}}{\text{kg}}}} - 6.37 \times 10^6 \text{ m}$$

$$h = .04 \times 10^6 \text{ m}$$

That is to say that at any altitude above 40 km above the surface of the earth, you should use Newton's Universal Law of Gravitation directly in order for your results to be good to within 1%.

In summary, $g = 9.80 \text{ N/kg}$ for the near-earth-surface gravitational field magnitude is an approximation to the Universal Law of Gravitation good to within about 1% anywhere within about 40 km of the surface of the earth. In that region, the value is approximately a constant because changes in elevation represent such a tiny fraction of the total earth's-center-to-surface distance as to be negligible.

The Universal Gravitational Potential Energy

So far in this course you have become familiar with two kinds of potential energy, the near-earth's-surface gravitational potential energy $U_g = mgy$ and the spring potential energy $U_s = \frac{1}{2}kx^2$. Here we introduce another expression for gravitational potential energy. This one is pertinent to situations for which the Universal Law of Gravitation is appropriate.

$$U_G = -\frac{Gm_1m_2}{r_{12}} \quad (17-5)$$

This is the gravitational potential energy of a pair of particles, one of mass m_1 and the other of mass m_2 , which are separated by a distance of r_{12} . Note that for a given pair of particles, the gravitational potential energy can take on values from negative infinity up to zero. Zero is the highest possible value and it is the value of the gravitational potential energy at infinite separation. That is to say that $U_G \xrightarrow{\lim r_{12} \rightarrow \infty} 0$. The lowest conceivable value is negative

infinity and it would be the value of the gravitational potential energy of the pair of particles if one could put them so close together that they were both at the same point in space. In mathematical notation: $U_G \xrightarrow{\lim r_{12} \rightarrow 0} -\infty$.

Conservation of Mechanical Energy Problems Involving Universal Gravitational Potential Energy for the Special Case in which the Total Amount of Mechanical Energy does not Change

You solve fixed amount of mechanical energy problems involving universal gravitational potential energy just as you solved fixed amount of mechanical energy problems involving other forms of potential energy back in chapters 2 and 3. Draw a good before and after picture, write an equation stating that the energy in the before picture is equal to the energy in the after picture, and proceed from there. To review these procedures, check out the example problem on the next page:

Example 17-1: How great would the muzzle velocity of a gun on the surface of the moon have to be in order to shoot a bullet to an altitude of 101 km?

Solution: We'll need the following lunar data:

Mass of the moon: $m_m = 7.35 \times 10^{22}$ kg ; Radius of the moon: $r_m = 1.74 \times 10^6$ m

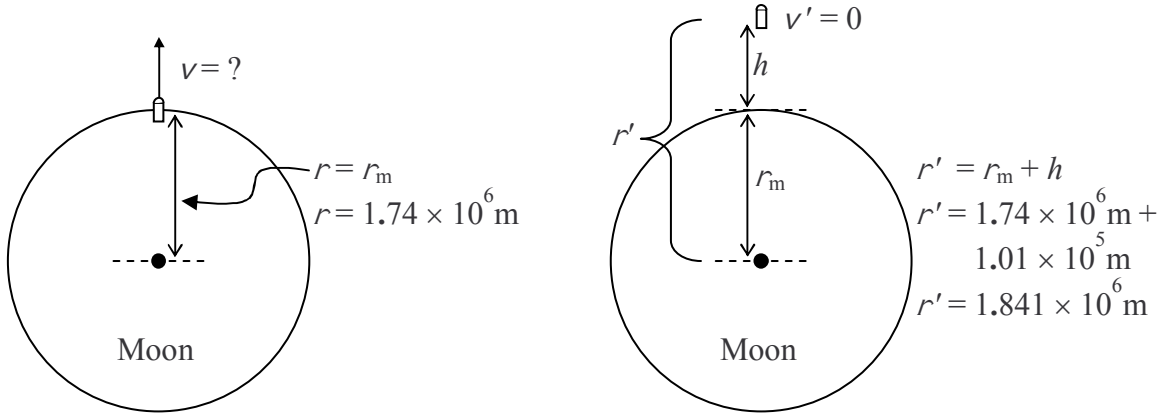

$$E = E'$$

$$K + U = K' + U'$$

$$\frac{1}{2}mv^2 + -\frac{Gm_m m}{r} = -\frac{Gm_m m}{r'}$$

(m_m is the mass of the moon and m is the mass of the bullet.)

$$\frac{1}{2}v^2 = \frac{Gm_m}{r} - \frac{Gm_m}{r'}$$

$$\frac{1}{2}v^2 = \frac{Gm_m}{r} - \frac{Gm_m}{r'}$$

$$\frac{1}{2}v^2 = Gm_m \left(\frac{1}{r} - \frac{1}{r'} \right)$$

$$v = \sqrt{2Gm_m \left(\frac{1}{r} - \frac{1}{r'} \right)}$$

$$v = \sqrt{2 \left(6.67 \times 10^{-11} \frac{\text{N} \cdot \text{m}^2}{\text{kg}^2} \right) 7.35 \times 10^{22} \text{ kg} \left(\frac{1}{1.74 \times 10^6 \text{ m}} - \frac{1}{1.841 \times 10^6 \text{ m}} \right)}$$

$$v = 556 \frac{\text{m}}{\text{s}}$$

18 Circular Motion: Centripetal Acceleration

There is a tendency to believe that if an object is moving at constant speed then it has no acceleration. This is indeed true in the case of an object moving along a straight line path. On the other hand, a particle moving on a curved path is accelerating whether the speed is changing or not. Velocity has both magnitude and direction. In the case of a particle moving on a curved path, the direction of the velocity is continually changing, and thus the particle has acceleration.

We now turn our attention to the case of an object moving in a circle. We'll start with the simplest case of circular motion, the case in which the speed of the object is a constant, a case referred to as uniform circular motion. For the moment, let's have you be the object. Imagine that you are in a car that is traveling counterclockwise, at say 40 mph, as viewed from above, around a fairly small circular track. You are traveling in a circle. Your velocity is not constant. The magnitude of your velocity is not changing (constant speed), but the direction of your velocity is continually changing, you keep turning left! Now if you are continually turning left then you must be continually acquiring some leftward velocity. In fact, your acceleration has to be exactly leftward, at right angles to your velocity because, if your speed is not changing, but your velocity is continually changing, meaning you have some acceleration $\vec{a} = \frac{d\vec{v}}{dt}$, then for every infinitesimal change in clock reading dt , the change in velocity $d\vec{v}$ that occurs during that infinitesimal time interval must be perpendicular to the velocity itself. (If it wasn't perpendicular, then the speed would be increasing or decreasing.) So no matter where you are in the circle (around which you are traveling counterclockwise as viewed from above) you have an acceleration directed exactly leftward, perpendicular to the direction of your velocity. Now what is always directly leftward of you if you are traveling counterclockwise around a circle? Precisely! The center of the circle is always directly leftward of you. Your acceleration is thus, always, center directed. We call the center-directed acceleration associated with circular motion centripetal acceleration because the word "centripetal" means "center-directed." Note that if you are traveling around the circle clockwise as viewed from above, you are continually turning right and your acceleration is directed rightward, straight toward the center of the circle. These considerations apply to any object—an object moving in a circle has centripetal (center-directed) acceleration.

We have a couple of ways of characterizing the motion of a particle that is moving in a circle. First, we characterize it in terms of how far the particle has traveled along the circle. If we need a position variable, we establish a start point on the circle and a positive direction. For instance, for a circle centered on the origin of an x - y plane we can define the point where the circle intersects the positive x axis as the start point, and define the direction in which the particle must move to go counterclockwise around the circle as the positive direction. The name given to this position variable is s . The position s is the total distance, measured along the circle, that the particle has traveled. The speed of the particle is then the rate of change of s , $\frac{ds}{dt}$ and the direction of the velocity is tangent to the circle. The circle itself is defined by its radius. The second method of characterizing the motion of a particle is to describe it in terms of an

imaginary line segment extending from the center of a circle to the particle. To use this method, one also needs to define a reference line segment—the positive x axis is the conventional choice for the case of a circle centered on the origin of an x - y coordinate system. Then, as long as you know the radius r of the circle, the angle θ that the line to the particle makes with the reference line completely specifies the location of the particle.

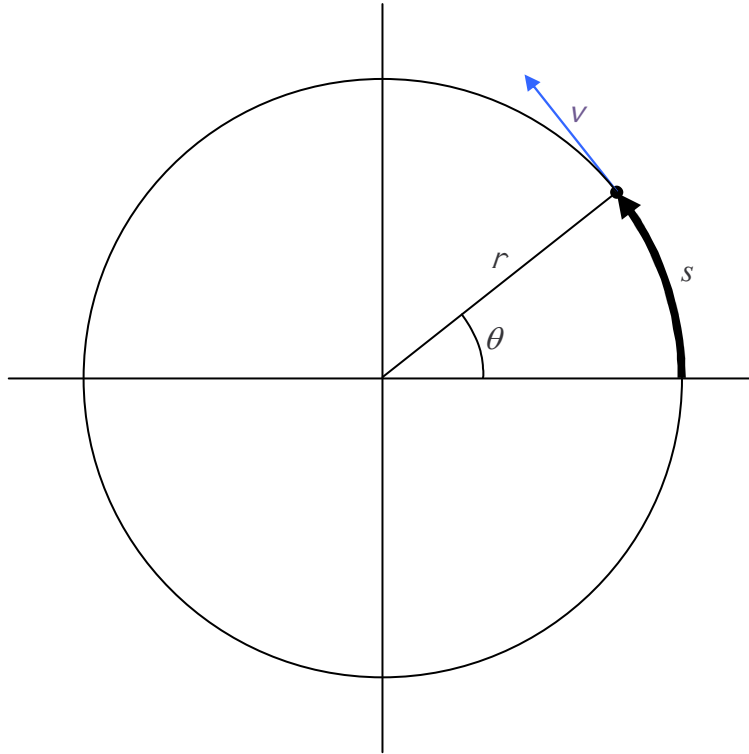

In geometry, the position variable s , defines an arc length on the circle. Recall that, by definition, the angle θ in radians is the ratio of the arc length to the radius:

$$\theta = \frac{s}{r}$$

Solving for s we have:

$$s = r\theta \tag{18-1}$$

in which we interpret the s to be the position-on-the-circle of the particle and the θ to be the angle that an imaginary line segment, from the center of the circle to the particle, makes with a reference line segment, such as the positive x -axis. Clearly, the faster the particle is moving, the faster the angle θ is changing, and indeed we can get a relation between the speed of the particle and the rate of change of θ just by taking the time derivative of both sides of equation 18-1. Let's do that.

Starting with equation 18-1:

$$s = r\theta$$

we take the derivative of both sides with respect to time:

$$\frac{ds}{dt} = r \frac{d\theta}{dt}$$

and then rewrite the result as

$$\dot{s} = r\dot{\theta}$$

just to get the reader used to the idea that we represent the time derivative of a variable, that is the rate of change of that variable, by the writing the symbol for the variable with a dot over it. Then we rewrite the result as

$$v = r\dot{\theta} \tag{18-2}$$

to emphasize the fact that the rate of change of the position-on-the-circle is the speed of the particle (the magnitude of the velocity of the particle). Finally, we define the variable ω (“omega”) to be the rate of change of the angle, meaning that ω is $\frac{d\theta}{dt}$ and ω is $\dot{\theta}$. It should be clear that ω is the spin rate for the imaginary line from the center of the circle to the particle. We call that spin rate the magnitude of the angular velocity of the line segment. (The expression *angular velocity*, ω , is more commonly used to characterize how fast and which way a *rigid body*, rather than an imaginary line, is spinning.) Rewriting $v = r\dot{\theta}$ with $\dot{\theta}$ replaced by ω yields:

$$v = r\omega \tag{18-3}$$

How the Centripetal Acceleration Depends on the Speed of the Particle and the Size of the Circle

We are now in a position to derive an expression for that center-directed (centripetal) acceleration we were talking about at the start of this chapter. Consider a short time interval Δt . (We will take the limit as Δt goes to zero before the end of this chapter.) During that short time interval, the particle travels a distance Δs along the circle and the angle that the line, from the center of the circle to the particle, makes with the reference line changes by an amount $\Delta\theta$

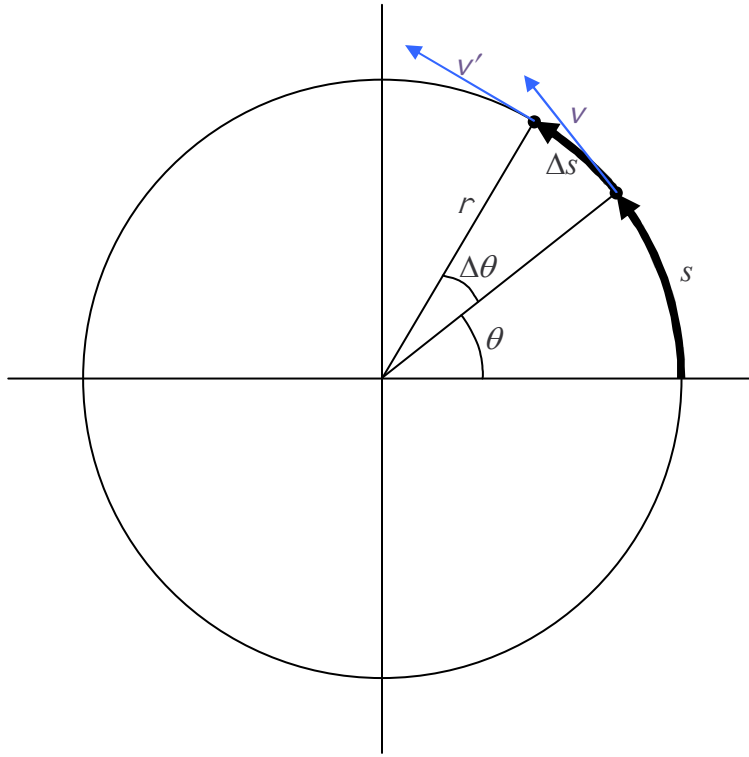

Furthermore, in that time Δt , the velocity of the particle changes from \vec{v} to \vec{v}' , a change $\Delta\vec{v}$ defined by $\vec{v}' = \vec{v} + \Delta\vec{v}$ depicted in the following vector diagram (in which the arrows representing the vectors \vec{v} and \vec{v}' have been copied from above with no change in orientation or length). Note that the small angle $\Delta\theta$ appearing in the vector addition diagram is the same $\Delta\theta$ that appears in the diagram above.

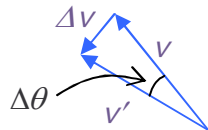

While \vec{v}' is a new vector, different from \vec{v} , we have stipulated that the speed of the particle is a constant, so the vector \vec{v}' has the same magnitude as the vector \vec{v} . That is, $v' = v$. We redraw the vector addition diagram labeling both velocity vectors with the same symbol v .

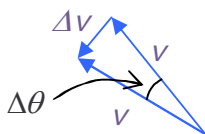

The magnitude of the centripetal acceleration, by definition, can be expressed as

$$a_c = \lim_{\Delta t \rightarrow 0} \frac{\Delta v}{\Delta t}$$

Look at the triangle in the vector addition diagram above. It is an isosceles triangle. The two unlabeled angles in the triangle are equal to each other. Furthermore, in the limit as Δt approaches 0, $\Delta\theta$ approaches 0, and as $\Delta\theta$ approaches 0, the other two angles must each approach 90° in order for the sum of the angles to remain 180° , as it must, because the sum of the interior angles for any triangle is 180° . Thus in the limit as Δt approaches 0, the triangle is a right triangle and in that limit we can write:

$$\frac{\Delta v}{v} = \tan(\Delta\theta)$$

$$\Delta v = v \tan(\Delta\theta)$$

Substituting this into our expression for a_c we have:

$$a_c = \lim_{\Delta t \rightarrow 0} \frac{v \tan(\Delta\theta)}{\Delta t} \quad (18-4)$$

Now we invoke the small angle approximation from the mathematics of plane geometry, an approximation which becomes an actual equation in the limit as $\Delta\theta$ approaches zero.

The Small Angle Approximation

For any angle that is very small compared to π radians (the smaller the angle the better the approximation), the tangent of the angle is approximately equal to the angle itself, expressed in radians; and the sine of the angle is approximately equal to the angle itself, expressed in radians. In fact,

$$\tan(\Delta\theta) \xrightarrow{\Delta\theta \rightarrow 0} \Delta\theta, \text{ and } \sin(\Delta\theta) \xrightarrow{\Delta\theta \rightarrow 0} \Delta\theta$$

where $\Delta\theta$ is in radians.

The small angle approximation allows us to write

$$a_c = \lim_{\Delta t \rightarrow 0} \frac{v \Delta \theta}{\Delta t} \quad [\text{where we have replaced the } \tan(\Delta \theta) \text{ in equation 18-4 above with } \Delta \theta].$$

The constant v can be taken outside the limit yielding $a_c = v \lim_{\Delta t \rightarrow 0} \frac{\Delta \theta}{\Delta t}$. But the $\lim_{\Delta t \rightarrow 0} \frac{\Delta \theta}{\Delta t}$ is the rate of change of the angle θ , which is, by definition, the angular velocity ω . Thus

$$a_c = v \omega$$

According to equation 18-3, $v = r\omega$. Solving that for ω we find that $\omega = \frac{v}{r}$. Substituting this into our expression for a_c yields

$$a_c = \frac{v^2}{r} \quad (18-5)$$

Please sound the drum roll! This is the result we have been seeking. Note that by substituting $r\omega$ for v , we can also write our result as

$$a_c = r \omega^2 \quad (18-6)$$

It should be pointed out that, despite the fact that we have been focusing our attention on the case in which the particle moving around the circle is moving at constant speed, the particle has centripetal acceleration whether the speed is changing or not. If the speed of the particle is changing, the centripetal acceleration at any instant is (still) given by 18-5 with the v being the speed of the particle at that instant (and in addition to the centripetal acceleration, the particle also has some along-the-circular-path acceleration known as tangential acceleration). The case that we have investigated is, however the remarkable case. Even if the speed of the particle is constant, the particle has some acceleration just because the direction of its velocity is continually changing. What's more, the centripetal acceleration is not a constant acceleration because its direction is continually changing. Visualize it. If you are driving counterclockwise (as viewed from above) around a circular track, the direction in which you see the center of the circle is continually changing (and that direction is the direction of the centripetal acceleration). When you are on the easternmost point of the circle the center is to the west of you. When you are at the northernmost point of the circle the center is to the south of you. When you are at the westernmost point of the circle, the center is to the east of you. And when you are at the southernmost point of the circle, the center is to the north of you.

19 Rotational Motion Variables, Tangential Acceleration, Constant Angular Acceleration

Because so much of the effort that we devote to dealing with angles involves acute angles, when we go to the opposite extreme, e.g. to angles of thousands of degrees, as we often do in the case of objects spinning with a constant angular acceleration, one of the most common mistakes we humans tend to make is simply not to recognize that when someone asks us; starting from time zero, how many revolutions, or equivalently how many turns or rotations an object makes; that someone is asking for the value of the angular displacement $\Delta\theta$. To be sure, we typically calculate $\Delta\theta$ in radians, so we have to convert the result to revolutions before reporting the final answer, but the number of revolutions is simply the value of $\Delta\theta$.

In the last chapter we found that a particle in uniform circular motion has centripetal acceleration given by equations 18-5 and 18-6:

$$a_c = \frac{v^2}{r} \qquad a_c = r\omega^2$$

It is important to note that any particle undergoing circular motion has centripetal acceleration, not just those in uniform (constant speed) circular motion. If the speed of the particle (the value of v in $a_c = \frac{v^2}{r}$) is changing, then the value of the centripetal acceleration is clearly changing.

One can still calculate it at any instant at which one knows the speed of the particle.

If, besides the acceleration that the particle has just because it is moving in a circle, the speed of the particle is changing, then the particle also has some acceleration directed along (or in the exact opposite direction to) the velocity of the particle. Since the velocity is always tangent to the circle on which the particle is moving, this component of the acceleration is referred to as the tangential acceleration of the particle. The magnitude of the tangential acceleration of a particle in circular motion is simply the absolute value of the rate of change of the speed of the particle

$a_t = \left| \frac{dv}{dt} \right|$. The direction of the tangential acceleration is the same as that of the velocity if the particle is speeding up, and in the direction opposite that of the velocity if the particle is slowing down.

Recall that, starting with our equation relating the position s of the particle along the circle to the angular position θ of a particle, $s = r\theta$, we took the derivative with respect to time to get the relation $v = r\omega$. If we take a second derivative with respect to time we get

$$\frac{dv}{dt} = r \frac{d\omega}{dt}$$

On the left we have the tangential acceleration a_t of the particle. The $\frac{d\omega}{dt}$ on the right is the time rate of change of the angular velocity of the object. The angular velocity is the spin rate, so a non-zero value of $\frac{d\omega}{dt}$ means that the imaginary line segment that extends from the center of the circle to the particle is spinning faster or slower as time goes by. In fact, $\frac{d\omega}{dt}$ is the rate at which the spin rate is changing. We call it the angular acceleration and use the symbol α (the Greek letter alpha) to represent it. Thus, the relation $\frac{dv}{dt} = r \frac{d\omega}{dt}$ can be expressed as

$$a_t = r \alpha \quad (19-1)$$

A Rotating Rigid Body

The characterization of the motion of a rotating rigid body has a lot in common with that of a particle traveling on a circle. In fact, every particle making up a rotating rigid body is undergoing circular motion. But different particles making up the rigid body move on circles of different radii and hence have speeds and accelerations that differ from each other. For instance, each time the object goes around once, every particle of the object goes all the way around its circle once, but a particle far from the axis of rotation goes all the way around circle that is bigger than the one that a particle that is close to the axis of rotation goes around. To do that, the particle far from the axis of rotation must be moving faster. But in one rotation of the object, the line from the center of the circle that any particle of the object is on, to the particle, turns through exactly one rotation. In fact, the angular motion variables that we have been using to characterize the motion of a line extending from the center of a circle to a particle that is moving on that circle can be used to characterize the motion of a spinning rigid body as a whole. There is only one spin rate for the whole object, the angular velocity ω , and if that spin rate is changing, there is only one rate of change of the spin rate, the angular acceleration α . To specify the angular position of a rotating rigid body, we need to establish a reference line on the rigid body, extending away from a point on the axis of rotation in a direction perpendicular to the axis of rotation. This reference line rotates with the object. Its motion is the angular motion of the object. We also need a reference line segment that is fixed in space, extending from the same point on the axis, and away from the axis in a direction perpendicular to the axis. This one does not rotate with the object. Imagining the two lines to have at one time been collinear, the net angle through which the first line on the rigid body has turned relative to the fixed line is the angular position θ of the object.

The Constant Angular Acceleration Equations

While physically, there is a huge difference, mathematically, the rotational motion of a rigid body is identical to motion of a particle that only moves along a straight line. As in the case of linear motion, we have to define a positive direction. We are free to define the positive direction whichever way we want for a given problem, but we have to stick with that definition throughout the problem. Here, we establish a viewpoint some distance away from the rotating rigid body,

but on the axis of rotation, and state that, from that viewpoint, counterclockwise is the positive sense of rotation, or alternatively, that clockwise is the positive sense of rotation. Whichever way we pick as positive, will be the positive sense of rotation for angular displacement (change in angular position), angular velocity, angular acceleration, and angular position relative to the reference line that is fixed in space. Next, we establish a zero for the time variable; we imagine a stopwatch to have been started at some instant that we define to be time zero. We call values of angular position and angular velocity, at that instant, the initial values of those quantities.

Given these criteria, we have the following table of corresponding quantities. Note that a rotational motion quantity is in no way equal to its linear motion counterpart, it simply plays a role in rotational motion that is mathematically similar to the role played by its counterpart in linear motion.

Linear Motion Quantity	Corresponding Angular Motion Quantity
x	θ
v	ω
a	α

The one variable that the two different kinds of motion do have in common is the stopwatch reading t .

Recall that, by definition,

$$\omega = \frac{d\theta}{dt}$$

and

$$\alpha = \frac{d\omega}{dt}$$

While it is certainly possible for α to be a variable, many cases arise in which α is a constant. Such a case is a special case. The following set of constant angular acceleration equations apply in the special case of constant angular acceleration: (The derivation of these equations is mathematically equivalent to the derivation of the constant linear acceleration equations. Rather than derive them again, we simply present the results.)

$$\theta = \theta_0 + \omega_0 t + \frac{1}{2} \alpha t^2 \quad (19-2)$$

$$\left(\begin{array}{l} \textit{The Constant} \\ \textit{Angular} \\ \textit{Acceleration} \\ \textit{Equations} \end{array} \right) \quad \theta = \theta_0 + \frac{\omega_0 + \omega}{2} t \quad (19-3)$$

$$\omega = \omega_0 + \alpha t \quad (19-4)$$

$$\omega^2 = \omega_0^2 + 2 \alpha \Delta\theta \quad (19-5)$$

Example 19-1

The rate at which a sprinkler head spins about a vertical axis increases steadily for the first 2.00 seconds of its operation such that, starting from rest, the sprinkler completes 15.0 revolutions clockwise (as viewed from above) during that first 2.00 seconds of operation. A nozzle, on the sprinkler head, at a distance of 11.0 cm from the axis of rotation of the sprinkler head, is initially due west of the axis of rotation. Find the direction and magnitude of the acceleration of the nozzle at the instant the sprinkler head completes its second (good to three significant figures) rotation.

Solution: We're told that the sprinkler head spin rate increases *steadily*, meaning that we are dealing with a constant angular acceleration problem, so, we can use the constant angular acceleration equations. The fact that there is a non-zero angular acceleration means that the nozzle will have some tangential acceleration \vec{a}_t . Also, the sprinkler head is spinning at the instant in question so the nozzle will have some centripetal acceleration \vec{a}_c . We'll have to find both \vec{a}_t and \vec{a}_c and add them like vectors to get the total acceleration of the nozzle. Let's get started by finding the angular acceleration α . We start with the first constant angular acceleration equation (equation 19-2):

$$\theta = \theta_0 + \omega_0 t + \frac{1}{2} \alpha t^2$$

The initial angular velocity ω_0 is given as zero. We have defined the initial angular position to be zero. This means that, at time $t = 2.00$ s, the angular position θ is

$$15.0 \text{ rev} = 15.0 \text{ rev} \frac{2\pi \text{ rad}}{\text{rev}} = 94.25 \text{ rad.}$$

Solving equation 19-2 above for α yields:

$$\alpha = \frac{2\theta}{t^2}$$

$$\alpha = \frac{2(94.25 \text{ rad})}{(2.00 \text{ s})^2}$$

$$\alpha = 47.12 \frac{\text{rad}}{\text{s}^2}$$

Substituting this result into equation 19-1:

$$a_t = r \alpha$$

gives us

$$a_t = (.110 \text{ m}) 47.12 \text{ rad/s}^2$$

which evaluates to

$$a_t = 5.18 \frac{\text{m}}{\text{s}^2} .$$

Now we need to find the angular velocity of the sprinkler head at the instant it completes 2.00 revolutions. The angular acceleration α that we found is constant for the first fifteen revolutions, so the value we found is certainly good for the first two turns. We can use it in the fourth constant angular acceleration equation (equation 19-5):

$$\omega^2 = \omega_0^2 + 2\alpha\Delta\theta$$

where $\Delta\theta = 2 \text{ rev} = 2.00 \text{ rev} \frac{2\pi \text{ rad}}{\text{rev}} = 4.00\pi \text{ rad}$

$$\omega = \sqrt{2\alpha\Delta\theta}$$

$$\omega = \sqrt{2(94.25 \text{ rad/s}^2)4.00\pi \text{ rad}}$$

$$\omega = 48.67 \text{ rad/s}$$

(at that instant when the sprinkler head completes its 2nd turn)

Now that we have the angular velocity, to get the centripetal acceleration we can use equation 18-6:

$$a_c = r\omega^2$$

$$a_c = .110 \text{ m} (48.67 \text{ rad/s})^2$$

$$a_c = 260.6 \frac{\text{m}}{\text{s}^2}$$

Given that the nozzle is initially at a point due west of the axis of rotation, at the end of 2.00 revolutions it will again be at that same point.

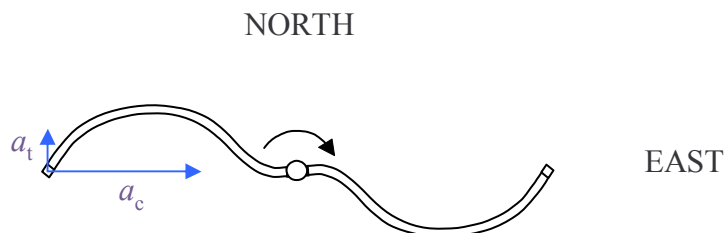

Now we just have to add the tangential acceleration and the centripetal acceleration vectorially to get the total acceleration. This is one of the easier kinds of vector addition problems since the vectors to be added are at right angles to each other.

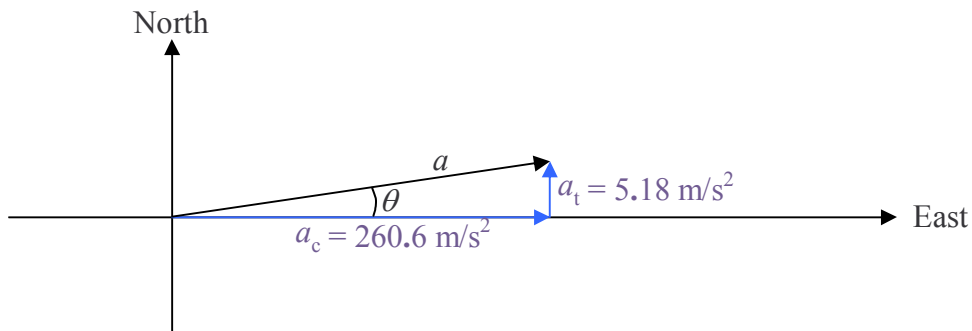

From Pythagorean's theorem we have

$$a = \sqrt{a_c^2 + a_t^2}$$

$$a = \sqrt{(260.6 \text{ m/s}^2)^2 + (5.18 \text{ m/s}^2)^2}$$

$$a = 261 \text{ m/s}^2$$

From the definition of the tangent of an angle as the opposite over the adjacent:

$$\tan \theta = \frac{a_t}{a_c}$$

$$\theta = \tan^{-1} \frac{a_t}{a_c}$$

$$\theta = \tan^{-1} \frac{5.18 \text{ m/s}^2}{260.6 \text{ m/s}^2}$$

$$\theta = 1.14^\circ$$

Thus

$$a = 261 \text{ m/s}^2 \text{ at } 1.14^\circ \text{ North of East}$$

When the Angular Acceleration is not Constant

The angular position of a rotating body undergoing constant angular acceleration is given, as a function of time, by our first constant angular acceleration equation, equation 19-2:

$$\theta = \theta_0 + \omega_0 t + \frac{1}{2} \alpha t^2$$

If we take the 2nd derivative of this with respect to time, we get the constant α . (Recall that the first derivative yields the angular velocity ω and that $\alpha = \frac{d\omega}{dt}$.) The expression on the right side of $\theta = \theta_0 + \omega_0 t + \frac{1}{2} \alpha t^2$ contains three terms: a constant, a term with t to the first power, and a term with t to the 2nd power. If you are given θ in terms of t , and it cannot be rearranged so that it appears as one of these terms or as a sum of two or all three such terms; then, α is not a constant and you cannot use the constant angular acceleration equations. Indeed, if you are being asked to find the angular velocity at a particular instant in time, then you'll want to take the derivative $\frac{d\theta}{dt}$ and evaluate the result at the given stopwatch reading. Alternatively, if you are being asked to find the angular acceleration at a particular instant in time, then you'll want to take the second derivative $\frac{d^2\theta}{dt^2}$ and evaluate the result at the given stopwatch reading.

Corresponding arguments can be made for the case of ω . If you are given ω as a function of t and the expression cannot be made to “look like” the constant angular acceleration equation $\omega = \omega_0 + \alpha t$ then you are not dealing with a constant angular acceleration situation and you should not use the constant angular acceleration equations.

20 Torque & Circular Motion

The mistake that crops up in the application of Newton's 2nd Law for Rotational Motion involves the replacement of the sum of the torques about some particular axis, $\sum \tau_{\odot}$, with a sum of terms that are not all torques. Oftentimes, the errant sum will include forces with no moment arms (a force times a moment arm is a torque, but a force by itself is not a torque) and in other cases the errant sum will include a term consisting of a torque times a moment arm (a torque is already a torque, multiplying it by a moment arm yields something that is not a torque). Folks that are in the habit of checking units will catch their mistake as soon as they plug in values with units and evaluate.

We have studied the motion of spinning objects without any discussion of torque. It is time to address the link between torque and rotational motion. First, let's review the link between force and translational motion. (Translational motion has to do with the motion of a particle through space. This is the ordinary motion that you've worked with quite a bit. Until we started talking about rotational motion we called translational motion "motion." Now, to distinguish it from rotational motion, we call it translational motion.) The real answer to the question of what causes motion to persist, is nothing—a moving particle with no force on it keeps on moving at constant velocity. However, whenever the velocity of the particle is changing, there is a force. The direct link between force and motion is a relation between force and acceleration. The relation is known as Newton's 2nd Law of Motion which we have written as equation 14-1:

$$\bar{a} = \frac{1}{m} \sum \bar{F}$$

in which,

\bar{a} is the acceleration of the object, how fast and which way its velocity is changing

m is the mass, a.k.a. inertia, of the object. $\frac{1}{m}$ can be viewed as a sluggishness factor, the

bigger the mass m , the smaller the value of $\frac{1}{m}$ and hence the smaller the acceleration of the object for a given net force. ("Net" in this context just means "total".)

$\sum \bar{F}$ is the vector sum of the forces acting on the object, the net force.

We find a completely analogous situation in the case of rotational motion. The link in the case of rotational motion is between the angular acceleration of a rigid body and the torque being exerted on that rigid body.

$$\vec{\alpha} = \frac{1}{I} \sum \vec{\tau} \quad (20-1)$$

in which,

$\vec{\alpha}$ is the angular acceleration of the rigid body, how fast and which way the angular velocity is changing

I is the moment of inertia, a.k.a. the rotational inertia (but not just plain old inertia, which is mass) of the rigid body. It is the rigid body's inherent resistance to a change in how fast it (the rigid body) is spinning. ("Inherent" means "of itself", "part of its own being.") $\frac{1}{I}$ can be viewed as a sluggishness factor, the bigger the rotational inertia I , the smaller the value of $\frac{1}{I}$ and hence the smaller the angular acceleration of the object for a given net torque.

$\sum \vec{\tau}$ is the net torque acting on the object. (A torque is what you are applying to a bottle cap or jar lid when you are trying to unscrew it.)

The Vector Nature of Torque and Angular Velocity

You've surely noticed the arrows over the letters used to represent torque, angular acceleration, and angular velocity; and as you know, the arrows mean that the quantities in question are vector quantities. That means that they have both magnitude and direction. Some explanation about the direction part is in order. Let's start with the torque. As mentioned, it is a twisting action such as that which you apply to bottle cap to loosen or tighten the bottle cap. There are two ways to specify the direction associated with torque. One way is to identify the axis of rotation about which the torque is being applied, then to establish a viewpoint, a position on the axis, at a location that is in one direction or the other direction away from the object. Then either state that the torque is clockwise, or state that it is counterclockwise, as viewed from the specified viewpoint. Note that it is not sufficient to identify the axis and state "clockwise" or "counterclockwise" without giving the viewpoint—a torque which is clockwise from one of the two viewpoints is counterclockwise from the other. The second method of specifying the direction is to give the torque vector direction. The convention for the torque vector is that the axis of rotation is the line on which the torque vector lies, and the direction is in accord with "the right hand rule for something curly something straight."

By the "the right hand rule for something curly something straight", if you point the thumb of your cupped right hand in the direction of the torque vector, the fingers will be curled around in that direction which corresponds to the sense of rotation (counterclockwise as viewed from the head of the torque vector looking back along the shaft) of the torque.

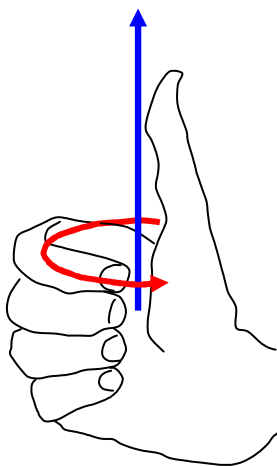

The angular acceleration vector $\vec{\alpha}$ and the angular velocity vector $\vec{\omega}$ obey the same convention. These vectors, which point along the axis about which the rotation they represent occurs, are referred to as axial vectors.

The Torque Due to a Force

When you apply a force to a rigid body, you are typically applying a torque to that rigid body at the same time. Consider an object that is free to rotate about a fixed axis. We depict the object as viewed from a position on the axis, some distance away from the object. From that viewpoint, the axis looks like a dot. We give the name “point O” to the position at which the axis of rotation appears in the diagram and label it “O” in the diagram to make it easier to refer to later in this discussion. There is a force \vec{F} acting on the object.

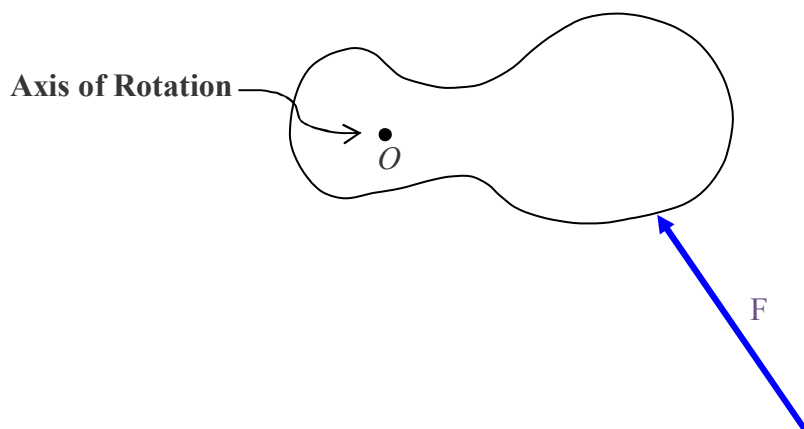

The magnitude of the torque due to a force is the magnitude of the force times the moment arm r_{\perp} (read “r perp”) of the force. The moment arm r_{\perp} is the perpendicular distance from the axis of rotation to the line of action of the force. The line of action of the force is a line that contains the force vector. Here we redraw the given diagram with the line of action of the force drawn in.

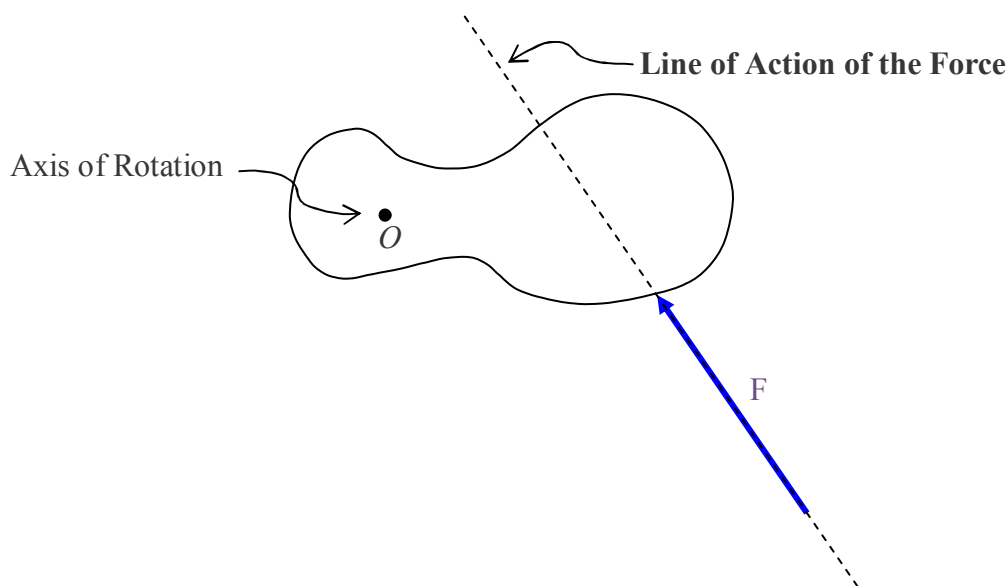

Next we extend a line segment from the axis of rotation to the line of action of the force, in such a manner that it meets the line of action of the force at right angles. The length of this line segment is the moment arm r_{\perp} .

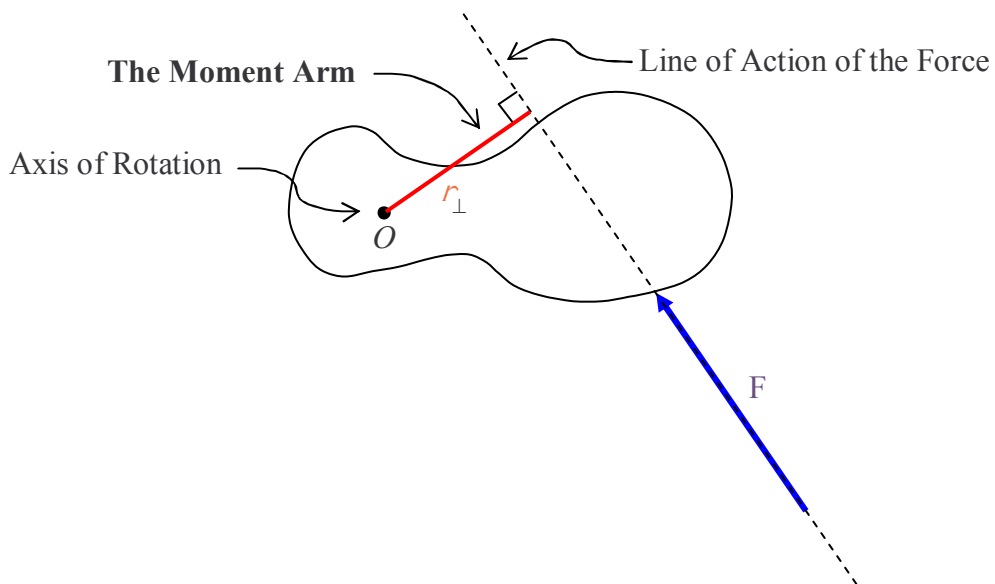

The magnitude of the torque about the specified axis of rotation is just the product of the moment arm and the force.

$$\tau = r_{\perp} F \quad (20-2)$$

Applying Newton's Second Law for Rotational Motion in Cases Involving a Fixed Axis

Starting on the next page, we tell you what steps are required (and what diagram is required) in the solution of a fixed-axis “Newton’s 2nd Law for Rotational Motion” problem by means of an example.

Example 20-1: A flat metal rectangular 293 mm \times 452 mm plate lies on a flat horizontal frictionless surface with (at the instant in question) one corner at the origin of an x-y coordinate system and the opposite corner at point P which is at (293 mm, 452 mm). The plate is **pin connected to the horizontal surface**¹ at (10.0 cm, 10.0 cm). A counterclockwise (as viewed from above) torque, with respect to the pin, of 15.0 N·m, is being applied to the plate and a force of 21.0 N in the $-y$ direction is applied to the corner of the plate at point P. The moment of inertia of the plate, with respect to the pin, is 1.28 kg·m². Find the angular acceleration of the plate at the instant for which the specified conditions prevail.

We start by drawing a pseudo free body diagram of the object as viewed from above (downward is “into the page”):

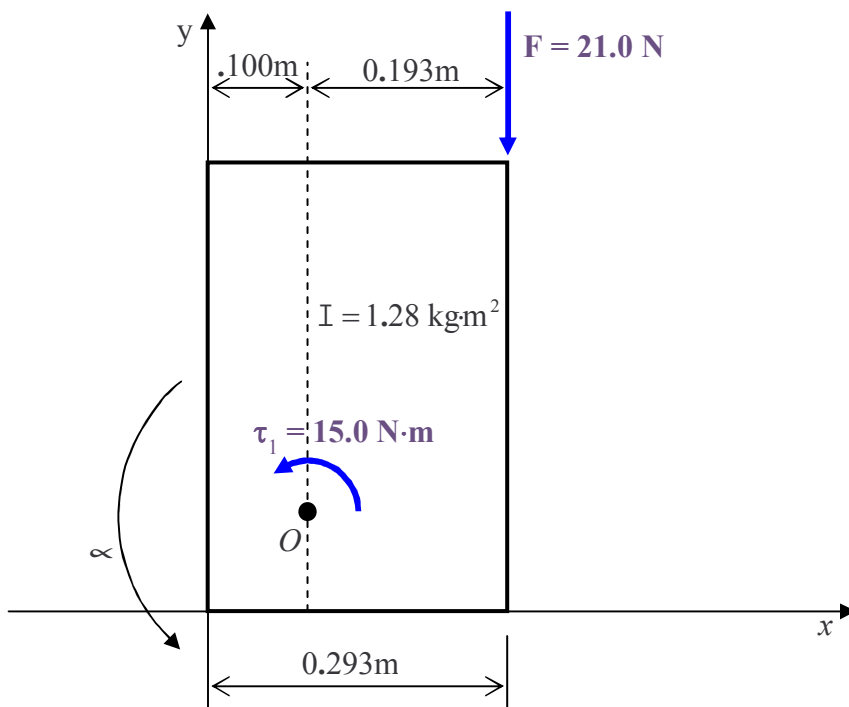

We refer to the diagram as a pseudo free body diagram rather than a free body diagram because:

- We omit forces that are parallel to the axis of rotation (because they do not affect the rotation of the object about the axis of rotation). In the case at hand, we have omitted the force exerted on the plate by the gravitational field of the earth (which would be “into the page” in the diagram) as well as the normal force exerted by the frictionless surface on the plate (“out of the page”).
- We ignore forces exerted on the plate by the pin. (Such forces have no moment arm and hence do not affect the rotation of the plate about the axis of rotation. Note, a pin can, however, exert a frictional torque—assume it to be zero unless otherwise specified.)

¹ “Pin connected to the horizontal surface” means that there is a short vertical axle fixed to the horizontal surface and passing through a small round hole in the plate so that the plate is free to spin about the axle. Assume that there is no frictional torque exerted on a pin-connected object unless otherwise specified in the case at hand.

Next we annotate the pseudo free body diagram to facilitate the calculation of the torque due to the force F :

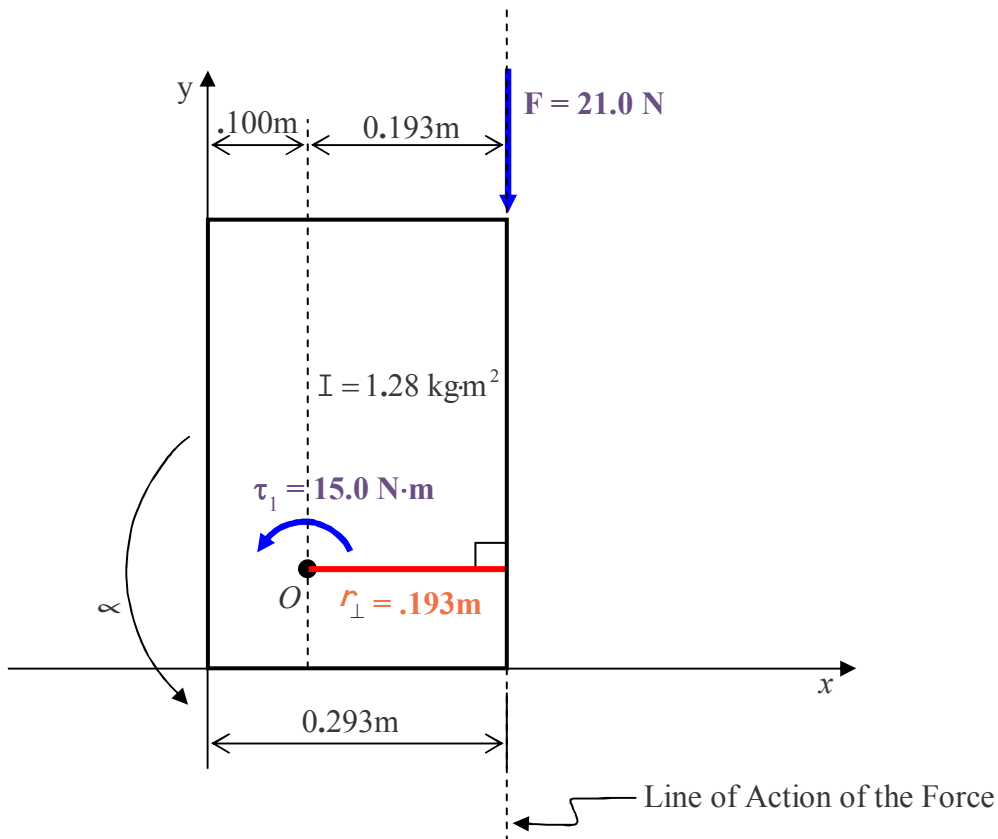

Now we go ahead and apply Newton's 2nd Law for Rotational Motion, equation 20-1 :

$$\vec{\alpha} = \frac{1}{I} \sum \vec{\tau}$$

As in the case of Newton's 2nd Law (for translational motion) this equation is three scalar equations in one, one equation for each of three mutually perpendicular axes about which rotation, under the most general circumstances, could occur. In the case at hand, the object is constrained to allow rotation about a single axis. In our solution, we need to indicate that we are summing torques about that axis, and we need to indicate which of the two possible rotational senses we are defining to be positive. We do that by means of the subscript \circlearrowleft to be read "counterclockwise about point O." Newton's 2nd Law for rotational motion about the vertical axis (perpendicular to the page and represented by the dot labeled "O" in the diagram) reads:

$$\alpha_{\circlearrowleft} = \frac{1}{I} \sum \tau_{\circlearrowleft} \quad (20-3)$$

Now, when we replace the expression $\frac{1}{I} \sum \tau_o$ with the actual term-by-term sum of the torques, we note that τ_1 is indeed counterclockwise as viewed from above (and hence positive) but that the force \vec{F} , where it is applied, would tend to cause a clockwise rotation of the plate, meaning that the torque associated with force \vec{F} is clockwise and hence, must enter the sum with a minus sign.

$$\alpha = \frac{1}{I}(\tau_1 - r_{\perp} F)$$

Substituting values with units yields:

$$\alpha = \frac{1}{1.28 \text{ kg} \cdot \text{m}^2} [15.0 \text{ N} \cdot \text{m} - 0.193 \text{ m}(21.0 \text{ N})]$$

Evaluating and rounding the answer to three significant figures gives us the final answer:

$$\alpha = 8.55 \frac{\text{rad}}{\text{s}^2} \quad (\text{counterclockwise as viewed from above})$$

Regarding the units we have:

$$\frac{1}{\text{kg} \cdot \text{m}^2} \text{N} \cdot \text{m} = \frac{1}{\text{kg} \cdot \text{m}^2} \frac{\text{kg} \cdot \text{m}}{\text{s}^2} = \frac{1}{\text{s}^2} = \frac{\text{rad}}{\text{s}^2}$$

where we have taken advantage of the fact that a newton is a $\frac{\text{kg} \cdot \text{m}}{\text{s}^2}$ and the fact that the radian is not a true unit but rather a marker that can be inserted as needed.

21 Vectors: The Cross Product & Torque

Do not use your left hand when applying either the right-hand rule for the cross product of two vectors (discussed in this chapter) or the right-hand rule for “something curly something straight” discussed in the preceding chapter.

There is a **relational operator**¹ for vectors that allows us to bypass the calculation of the moment arm. The relational operator is called the cross product. It is represented by the symbol “ \times ” read “cross.” The torque $\vec{\tau}$ can be expressed as the cross product of the position vector \vec{r} for the point of application of the force, and the force vector \vec{F} itself:

$$\vec{\tau} = \vec{r} \times \vec{F} \quad (21-1)$$

Before we begin our mathematical discussion of what we mean by the cross product, a few words about the vector \vec{r} are in order. It is important for you to be able to distinguish between the position vector \vec{r} for the force, and the moment arm, so we present them below in one and the same diagram. We use the same example that we have used before:

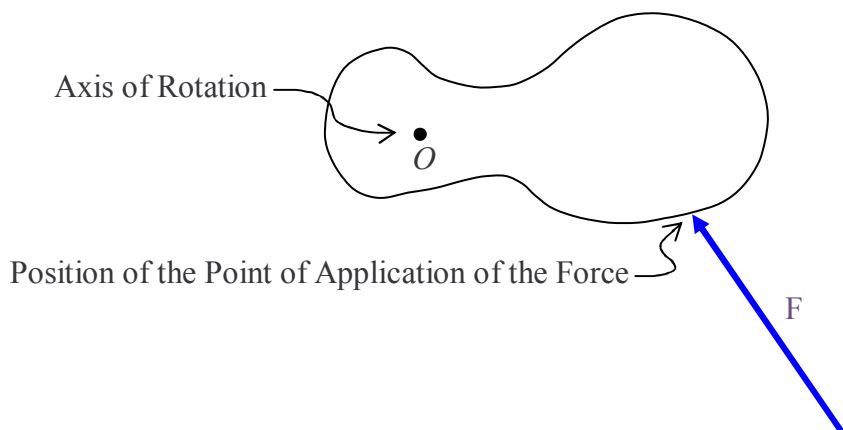

in which we are looking directly along the axis of rotation (so it looks like a dot) and the force lies in a plane perpendicular to that axis of rotation. We use the diagrammatic convention that, the point at which the force is applied to the rigid body is the point at which one end of the arrow in the diagram touches the rigid body. Now we add the line of action of the force and the moment arm r_{\perp} to the diagram, as well as the position vector \vec{r} of the point of application of the force.

¹ You are much more familiar with relational operators than you might realize. The + sign is a relational operator for scalars (numbers). The operation is addition. Applying it to the numbers 2 and 3 yields $2+3=5$. You are also familiar with the relational operators $-$, \cdot , and \div for subtraction, multiplication, and division (of scalars) respectively.

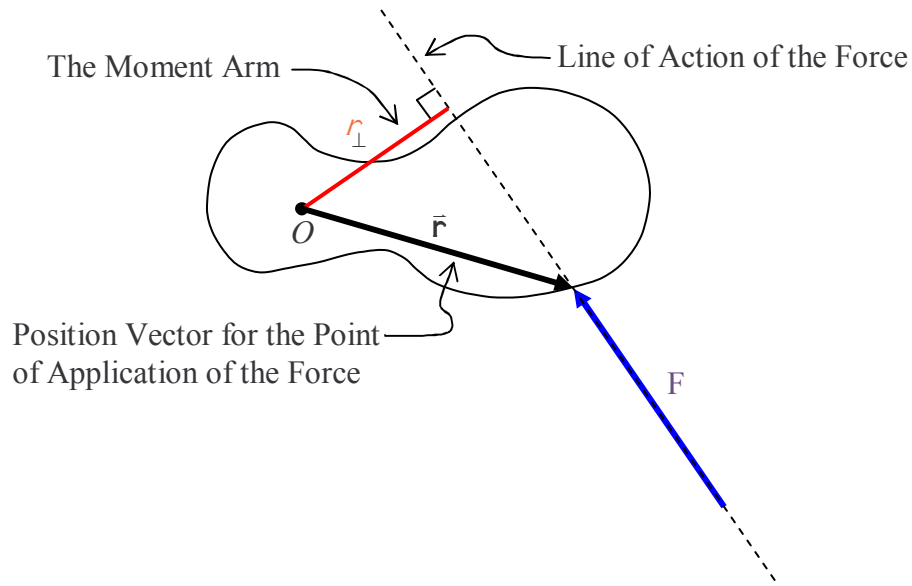

The moment arm can actually be defined in terms of the position vector for the point of application of the force. Consider a tilted x - y coordinate system, having an origin on the axis of rotation, with one axis parallel to the line of action of the force and one axis perpendicular to the line of action of the force. We label the x axis \perp for “perpendicular” and the y axis \parallel for “parallel.”

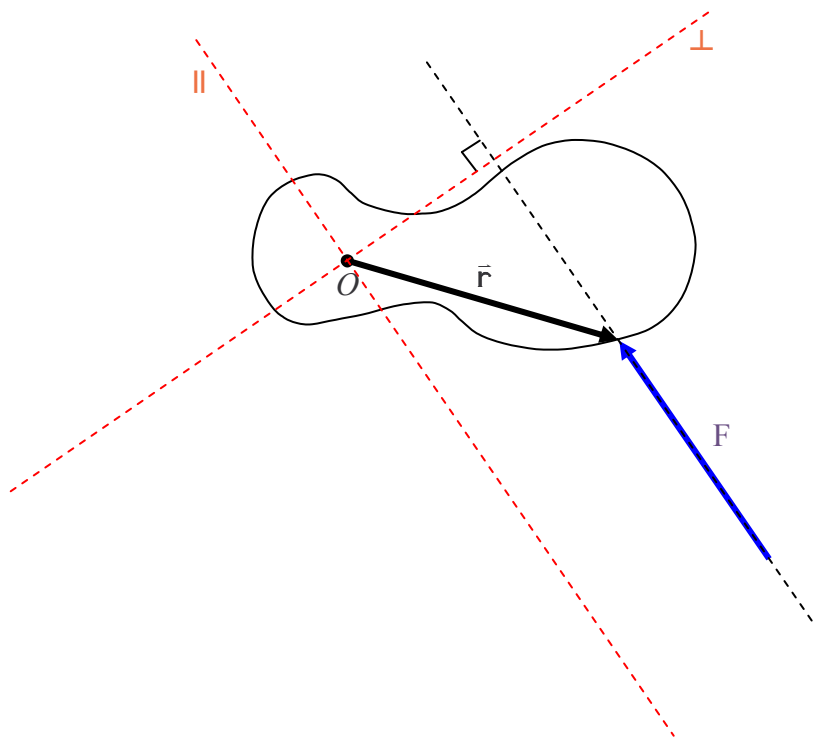

Now we break up the position vector \vec{r} into its component vectors along the \perp and \parallel axes.

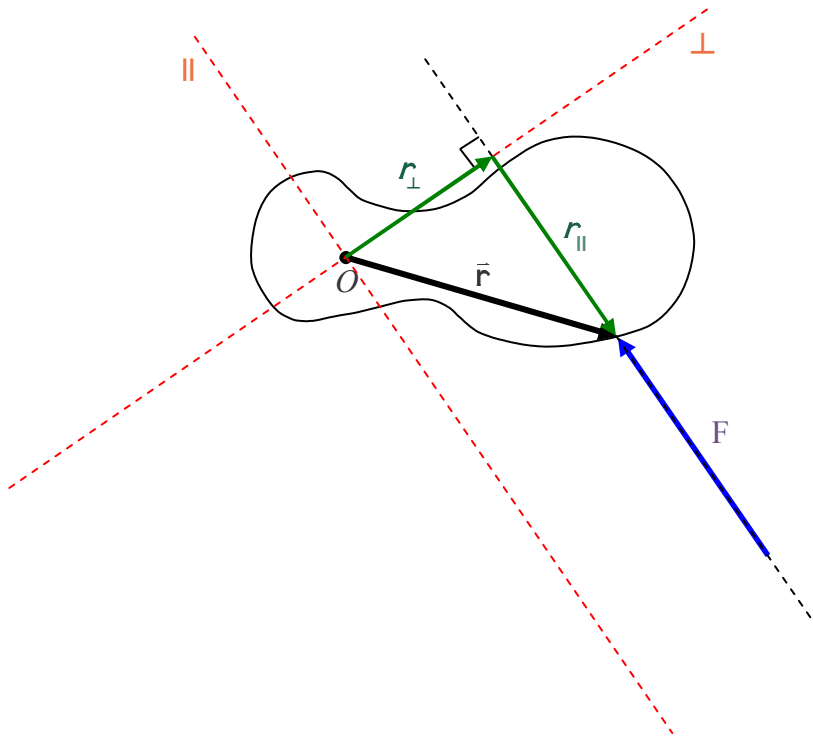

From the diagram it is clear that the moment arm r_{\perp} is just the magnitude of the component vector, in the perpendicular-to-the-force direction, of the position vector of the point of application of the force.

Now let's discuss the cross product in general terms. Consider two vectors, $\vec{\mathbf{A}}$ and $\vec{\mathbf{B}}$ that are neither parallel nor **anti-parallel**² to each other. Two such vectors define a plane.

Let that plane be the plane of the page and define θ to be the smaller of the two angles between the two vectors when the vectors are drawn tail to tail.

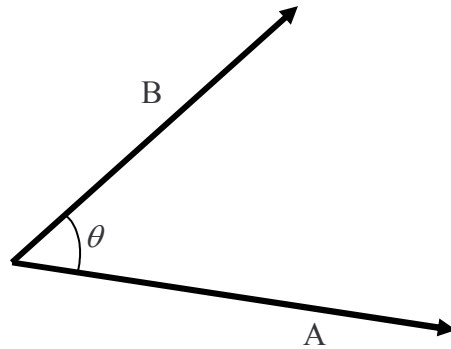

The magnitude of the cross product vector $\vec{\mathbf{A}} \times \vec{\mathbf{B}}$ is given by

$$|\vec{\mathbf{A}} \times \vec{\mathbf{B}}| = AB \sin \theta \quad (21-2)$$

The direction of the cross product vector $\vec{\mathbf{A}} \times \vec{\mathbf{B}}$ is given by the right-hand rule for the cross product of two **vectors**³. To apply this right-hand rule, extend the fingers of your right hand so that they are pointing directly away from your right elbow. Extend your thumb so that it is at right angles to your fingers.

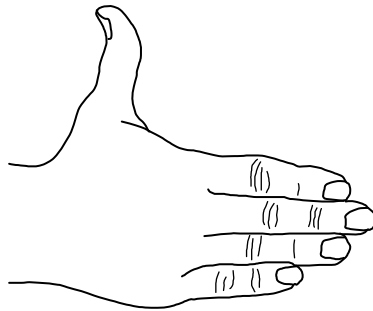

² Two vectors that are anti-parallel are in exact opposite directions to each other. The angle between them is 180° degrees. Anti-parallel vectors lie along parallel lines or along one and the same line, but point in opposite directions.

³ You need to learn two right-hand rules for this course: the “right-hand rule for something curly something straight,” and this one, the right-hand rule for the cross product of two vectors.

Keeping your fingers aligned with your forearm, point your fingers in the direction of the first vector (the one that appears before the “ \times ” in the mathematical expression for the cross product; e.g. the \vec{A} in $\vec{A} \times \vec{B}$).

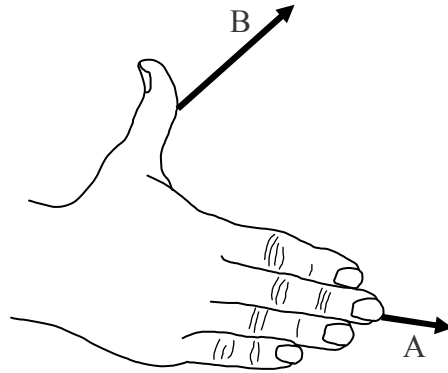

Now rotate your hand, as necessary, about an imaginary axis extending along your forearm and along your middle finger, until your hand is oriented such that, if you were to close your fingers, they would point in the direction of the second vector.

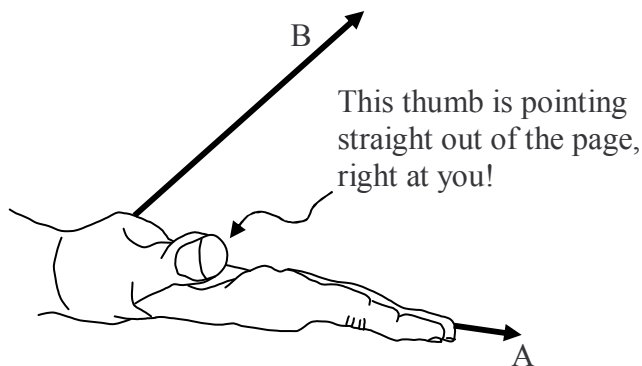

Your thumb is now pointing in the direction of the cross product vector. $\vec{C} = \vec{A} \times \vec{B}$. The cross product vector \vec{C} is always perpendicular to both of the vectors that are in the cross product (the \vec{A} and the \vec{B} in the case at hand). Hence, if you draw them so that both of the vectors that are in the cross product are in the plane of the page, the cross product vector will always be perpendicular to the page, either straight into the page, or straight out of the page. In the case at hand, it is straight out of the page.

When we use the cross product to calculate the torque due to a force \vec{F} whose point of application has a position vector \vec{r} , relative to the point about which we are calculating the torque, we get an axial torque vector $\vec{\tau}$. To determine the sense of rotation that such a torque vector would correspond to, about the axis defined by the torque vector itself, we use The Right Hand Rule For Something Curly Something Straight. Note that we are calculating the torque with respect to a point rather than an axis—the axis about which the torque acts, comes out in the answer.

Calculating the Cross Product of Vectors that are Given in \hat{i} , \hat{j} , \hat{k} Notation

Unit vectors allow for a straightforward calculation of the cross product of two vectors under even the most general circumstances, e.g. circumstances in which each of the vectors is pointing in an arbitrary direction in a three-dimensional space. To take advantage of the method, we need to know the cross product of the Cartesian coordinate axis unit vectors \hat{i} , \hat{j} , and \hat{k} with each other.

First off, we should note that any vector crossed into itself gives zero. This is evident from equation 21-2:

$$|\vec{A} \times \vec{B}| = AB \sin \theta,$$

because if A and B are in the same direction, then $\theta = 0^\circ$, and since $\sin 0^\circ = 0$, we have $|\vec{A} \times \vec{B}| = 0$. Regarding the unit vectors, this means that:

$$\begin{aligned}\hat{i} \times \hat{i} &= 0 \\ \hat{j} \times \hat{j} &= 0 \\ \hat{k} \times \hat{k} &= 0\end{aligned}$$

Next we note that the magnitude of the cross product of two vectors that are perpendicular to each other is just the ordinary product of the magnitudes of the vectors. This is also evident from equation 21-2:

$$|\vec{A} \times \vec{B}| = AB \sin \theta,$$

because if \vec{A} is perpendicular to \vec{B} then $\theta = 90^\circ$ and $\sin 90^\circ = 1$ so

$$|\vec{A} \times \vec{B}| = AB$$

Now if \vec{A} and \vec{B} are unit vectors, then their magnitudes are both 1, so, the product of their magnitudes is also 1. Furthermore, the unit vectors \hat{i} , \hat{j} , and \hat{k} are all perpendicular to each other so the *magnitude* of the cross product of any one of them with any other one of them is the product of the two magnitudes, that is, 1.

Now how about the direction? Let's use the right hand rule to get the direction of $\hat{i} \times \hat{j}$:

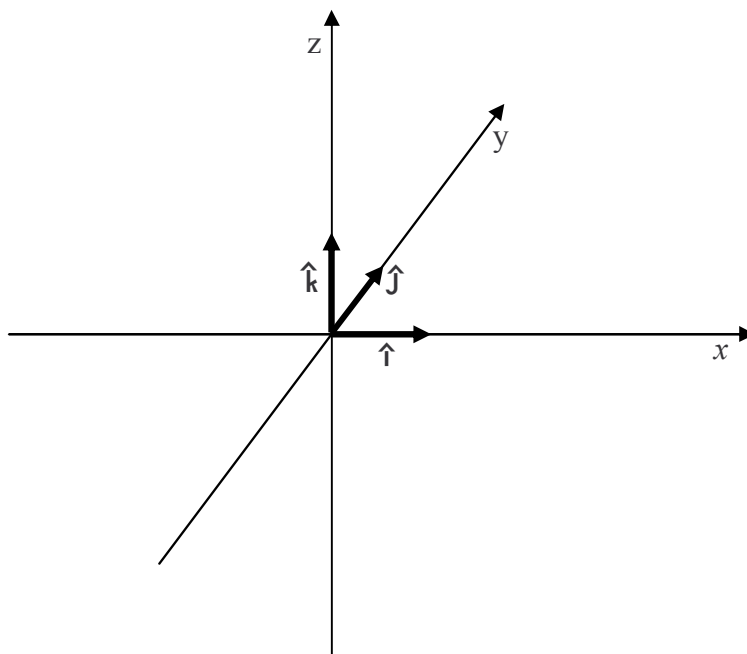

Figure 1

With the fingers of the right hand pointing directly away from the right elbow, and in the same direction as \hat{i} , (the *first* vector in " $\hat{i} \times \hat{j}$ ") to make it so that if one were to close the fingers, they would point in the same direction as \hat{j} , the palm must be facing in the $+y$ direction. That being the case, the extended thumb must be pointing in the $+z$ direction. Putting the magnitude (the magnitude of each unit vector is 1) and direction ($+z$) information together we **see**⁴ that $\hat{i} \times \hat{j} = \hat{k}$. Similarly: $\hat{j} \times \hat{k} = \hat{i}$, $\hat{k} \times \hat{i} = \hat{j}$, $\hat{j} \times \hat{i} = -\hat{k}$, $\hat{k} \times \hat{j} = -\hat{i}$, and $\hat{i} \times \hat{k} = -\hat{j}$. One way of remembering this is to write $\hat{i}, \hat{j}, \hat{k}$ twice in succession:

$\hat{i}, \hat{j}, \hat{k}, \hat{i}, \hat{j}, \hat{k}$

Then, crossing any one of the first three vectors into the vector immediately to its right yields the next vector to the right. But crossing any one of the last three vectors into the vector

⁴ You may have picked up on a bit of circular reasoning here. Note that in Figure 1, if we had chosen to have the z axis point in the opposite direction (keeping x and y as shown) then $\hat{i} \times \hat{j}$ would be pointing in the $-z$ direction. In fact, having chosen the $+x$ and $+y$ directions, we define the $+z$ direction as that direction that makes $\hat{i} \times \hat{j} = \hat{k}$. Doing so forms what is referred to as a right-handed coordinate system which is, by convention, the kind of coordinate system that we use in science and mathematics. If $\hat{i} \times \hat{j} = -\hat{k}$ then you are dealing with a left-handed coordinate system, something to be avoided.

immediately to its left yields the *negative* of the next vector to the left (left-to-right “+”, but right-to-left “-”).

Now we’re ready to look at the general case. Any vector $\vec{\mathbf{A}}$ can be expressed in terms of unit vectors:

$$\vec{\mathbf{A}} = A_x \hat{\mathbf{i}} + A_y \hat{\mathbf{j}} + A_z \hat{\mathbf{k}}$$

Doing the same for a vector $\vec{\mathbf{B}}$ then allows us to write the cross product as:

$$\vec{\mathbf{A}} \times \vec{\mathbf{B}} = (A_x \hat{\mathbf{i}} + A_y \hat{\mathbf{j}} + A_z \hat{\mathbf{k}}) \times (B_x \hat{\mathbf{i}} + B_y \hat{\mathbf{j}} + B_z \hat{\mathbf{k}})$$

Using the distributive rule for multiplication we can write this as:

$$\begin{aligned} \vec{\mathbf{A}} \times \vec{\mathbf{B}} &= A_x \hat{\mathbf{i}} \times (B_x \hat{\mathbf{i}} + B_y \hat{\mathbf{j}} + B_z \hat{\mathbf{k}}) + \\ &A_y \hat{\mathbf{j}} \times (B_x \hat{\mathbf{i}} + B_y \hat{\mathbf{j}} + B_z \hat{\mathbf{k}}) + \\ &A_z \hat{\mathbf{k}} \times (B_x \hat{\mathbf{i}} + B_y \hat{\mathbf{j}} + B_z \hat{\mathbf{k}}) \end{aligned}$$

$$\begin{aligned} \vec{\mathbf{A}} \times \vec{\mathbf{B}} &= A_x \hat{\mathbf{i}} \times B_x \hat{\mathbf{i}} + A_x \hat{\mathbf{i}} \times B_y \hat{\mathbf{j}} + A_x \hat{\mathbf{i}} \times B_z \hat{\mathbf{k}} + \\ &A_y \hat{\mathbf{j}} \times B_x \hat{\mathbf{i}} + A_y \hat{\mathbf{j}} \times B_y \hat{\mathbf{j}} + A_y \hat{\mathbf{j}} \times B_z \hat{\mathbf{k}} + \\ &A_z \hat{\mathbf{k}} \times B_x \hat{\mathbf{i}} + A_z \hat{\mathbf{k}} \times B_y \hat{\mathbf{j}} + A_z \hat{\mathbf{k}} \times B_z \hat{\mathbf{k}} \end{aligned}$$

Using, in each term, the commutative rule and the associative rule for multiplication we can write this as:

$$\begin{aligned} \vec{\mathbf{A}} \times \vec{\mathbf{B}} &= A_x B_x (\hat{\mathbf{i}} \times \hat{\mathbf{i}}) + A_x B_y (\hat{\mathbf{i}} \times \hat{\mathbf{j}}) + A_x B_z (\hat{\mathbf{i}} \times \hat{\mathbf{k}}) + \\ &A_y B_x (\hat{\mathbf{j}} \times \hat{\mathbf{i}}) + A_y B_y (\hat{\mathbf{j}} \times \hat{\mathbf{j}}) + A_y B_z (\hat{\mathbf{j}} \times \hat{\mathbf{k}}) + \\ &A_z B_x (\hat{\mathbf{k}} \times \hat{\mathbf{i}}) + A_z B_y (\hat{\mathbf{k}} \times \hat{\mathbf{j}}) + A_z B_z (\hat{\mathbf{k}} \times \hat{\mathbf{k}}) \end{aligned}$$

Now we evaluate the cross product that appears in each term:

$$\begin{aligned} \vec{\mathbf{A}} \times \vec{\mathbf{B}} &= A_x B_x (0) + A_x B_y (\hat{\mathbf{k}}) + A_x B_z (-\hat{\mathbf{j}}) + \\ &A_y B_x (-\hat{\mathbf{k}}) + A_y B_y (0) + A_y B_z (\hat{\mathbf{i}}) + \\ &A_z B_x (\hat{\mathbf{j}}) + A_z B_y (-\hat{\mathbf{i}}) + A_z B_z (0) \end{aligned}$$

Eliminating the zero terms and grouping the terms with $\hat{\mathbf{i}}$ together, the terms with $\hat{\mathbf{j}}$ together, and the terms with $\hat{\mathbf{k}}$ together yields:

$$\begin{aligned}\bar{\mathbf{A}} \times \bar{\mathbf{B}} &= A_y B_z (\hat{\mathbf{i}}) + A_z B_y (-\hat{\mathbf{i}}) + \\ &A_z B_x (\hat{\mathbf{j}}) + A_x B_z (-\hat{\mathbf{j}}) + \\ &A_x B_y (\hat{\mathbf{k}}) + A_y B_x (-\hat{\mathbf{k}})\end{aligned}$$

Factoring out the unit vectors yields:

$$\begin{aligned}\bar{\mathbf{A}} \times \bar{\mathbf{B}} &= (A_y B_z - A_z B_y) \hat{\mathbf{i}} + \\ &(A_z B_x - A_x B_z) \hat{\mathbf{j}} + \\ &(A_x B_y - A_y B_x) \hat{\mathbf{k}}\end{aligned}$$

which can be written on one line as:

$$\bar{\mathbf{A}} \times \bar{\mathbf{B}} = (A_y B_z - A_z B_y) \hat{\mathbf{i}} + (A_z B_x - A_x B_z) \hat{\mathbf{j}} + (A_x B_y - A_y B_x) \hat{\mathbf{k}} \quad (21-3)$$

This is our end result. We can arrive at this result much more quickly if we borrow a tool from that branch of mathematics known as linear algebra (the mathematics of matrices).

We form the 3×3 matrix

$$\begin{bmatrix} \hat{\mathbf{i}} & \hat{\mathbf{j}} & \hat{\mathbf{k}} \\ A_x & A_y & A_z \\ B_x & B_y & B_z \end{bmatrix}$$

by writing $\hat{\mathbf{i}}, \hat{\mathbf{j}}, \hat{\mathbf{k}}$ as the first row, then the components of the *first* vector that appears in the cross product as the second row, and finally the components of the second vector that appears in the cross product as the last row. It turns out that the cross product is equal to the *determinant* of that matrix. We use absolute value signs on the entire matrix to signify “the determinant of the matrix.” So we have:

$$\bar{\mathbf{A}} \times \bar{\mathbf{B}} = \begin{vmatrix} \hat{\mathbf{i}} & \hat{\mathbf{j}} & \hat{\mathbf{k}} \\ A_x & A_y & A_z \\ B_x & B_y & B_z \end{vmatrix} \quad (21-4)$$

To take the determinant of a 3×3 matrix you work your way across the top row. For each element in that row you take the product of the elements along the diagonal that extends down and to the right, minus the product of the elements down and to the left; and you add the three results (one result for each element in the top row) together. If there are no elements down and to the appropriate side, you move over to the other side of the matrix (see below) to complete the diagonal.

For the first element of the first row, the \hat{i} , take the product down and to the right,

$$\begin{array}{ccc} \hat{i} & \hat{j} & \hat{k} \\ A_x & A_y & A_z \\ B_x & B_y & B_z \end{array}$$

(this yields $\hat{i} A_y B_z$)

minus the product down and to the left

$$\begin{array}{ccc} \hat{i} & \hat{j} & \hat{k} \\ A_x & A_y & A_z \\ B_x & B_y & B_z \end{array}$$

(the product down-and-to-the-left is $\hat{i} A_z B_y$).

For the first element in the first row, we thus have: $\hat{i} A_y B_z - \hat{i} A_z B_y$ which can be written as: $(A_y B_z - A_z B_y)\hat{i}$. Repeating the process for the second and third elements in the first row (the \hat{j} and the \hat{k}) we get $(A_z B_x - A_x B_z)\hat{j}$ and $(A_x B_y - A_y B_x)\hat{k}$ respectively. Adding the three results, to form the determinant of the matrix results in:

$$\vec{A} \times \vec{B} = (A_y B_z - A_z B_y)\hat{i} + (A_z B_x - A_x B_z)\hat{j} + (A_x B_y - A_y B_x)\hat{k} \quad (21-3)$$

as we found before, “the hard way.”

22 Center of Mass, Moment of Inertia

A mistake that crops up in the calculation of moments of inertia, involves the Parallel Axis Theorem. The mistake is to interchange the moment of inertia of the axis through the center of mass, with the one parallel to that, when applying the Parallel Axis Theorem. Recognizing that the subscript “CM” in the parallel axis theorem stands for “center of mass” will help one avoid this mistake. Also, a check on the answer, to make sure that the value of the moment of inertia with respect to the axis through the center of mass is smaller than the other moment of inertia, will catch the mistake.

Center of Mass

Consider two particles, having one and the same mass m , each of which is at a different position on the x axis of a Cartesian coordinate system.

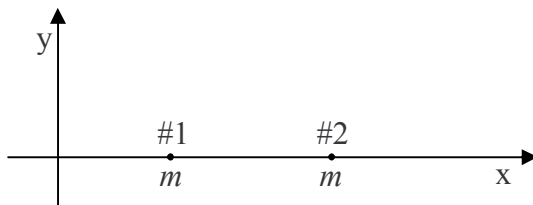

Common sense tells you that the average position of the material making up the two particles is midway between the two particles. Common sense is right. We give the name “center of mass” to the average position of the material making up a distribution, and the center of mass of a pair of same-mass particles is indeed midway between the two particles.

How about if one of the particles is more massive than the other? One would expect the center of mass to be closer to the more massive particle, and again, one would be right. To determine the position of the center of mass of the distribution of matter in such a case, we compute a weighted sum of the positions of the particles in the distribution, where the weighting factor for a given particle is that fraction, of the total mass, that the particle’s own mass is. Thus, for two particles on the x axis, one of mass m_1 , at x_1 , and the other of mass m_2 , at x_2 ,

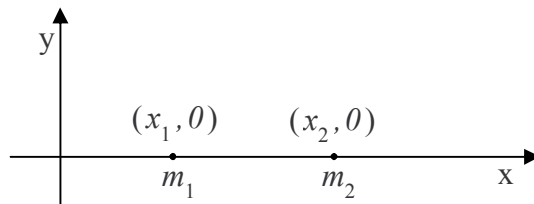

the position \bar{x} of the center of mass is given by

$$\bar{x} = \frac{m_1}{m_1 + m_2} x_1 + \frac{m_2}{m_1 + m_2} x_2 \quad (22-1)$$

Note that each weighting factor is a proper fraction and that the sum of the weighting factors is always 1. Also note that if, for instance, m_1 is greater than m_2 , then the position x_1 of particle 1 will count more in the sum, thus ensuring that the center of mass is found to be closer to the more massive particle (as we know it must be). Further note that if $m_1 = m_2$, each weighting factor is $\frac{1}{2}$, as is evident when we substitute m for both m_1 and m_2 in equation 22-1:

$$\bar{x} = \frac{m}{m + m} x_1 + \frac{m}{m + m} x_2$$

$$\bar{x} = \frac{1}{2} x_1 + \frac{1}{2} x_2$$

$$\bar{x} = \frac{x_1 + x_2}{2}$$

The center of mass is found to be midway between the two particles, right where common sense tells us it has to be.

The Center of Mass of a Thin Rod

Quite often, when the finding of the position of the center of mass of a distribution of particles is called for, the distribution of particles is the set of particles making up a rigid body. The easiest rigid body for which to calculate the center of mass is the thin rod because it extends in only one dimension. (Here, we discuss an ideal thin rod. A physical thin rod must have some non-zero diameter. The ideal thin rod, however, is a good approximation to the physical thin rod as long as the diameter of the rod is small compared to its length.)

In the simplest case, the calculation of the position of the center of mass is trivial. The simplest case involves a *uniform* thin rod. A uniform thin rod is one for which the linear mass density μ , the mass-per-length of the rod, has one and the same value at all points on the rod. The center of mass of a uniform rod is at the center of the rod. So, for instance, the center of mass of a uniform rod that extends along the x axis from $x = 0$ to $x = L$ is at $(L/2, 0)$.

The *linear mass density* μ , typically called *linear density* when the context is clear, is a measure of how closely packed the elementary particles making up the rod are. Where the linear density is high, the particles are close together.

To picture what is meant by a non-uniform rod, a rod whose linear density is a function of position, imagine a thin rod made of an alloy consisting of lead and aluminum. Further imagine that the percentage of lead in the rod varies smoothly from 0% at one end of the rod to 100% at the other. The linear density of such a rod would be a function of the position along the length of the rod. A one-millimeter segment of the rod at one position would have a different mass than that of a one-millimeter segment of the rod at a different position.

People with some exposure to calculus have an easier time understanding what linear density is than calculus-deprived individuals do because linear density is just the ratio of the amount of mass in a rod segment to the length of the segment, in the limit as the length of the segment goes to zero. Consider a rod that extends from 0 to L along the x axis. Now suppose that $m_s(x)$ is the mass of that segment of the rod extending from 0 to x where $x \geq 0$ but $x < L$. Then, the linear density of the rod at any point x along the rod, is just $\frac{dm_s}{dx}$ evaluated at the value of x in question.

Now that you have a good idea of what we mean by linear mass density, we are going to illustrate how one determines the position of the center of mass of a non-uniform thin rod by means of an example.

Example 22-1

Find the position of the center of mass of a thin rod that extends from 0 to .890 m along the x axis of a Cartesian coordinate system and has a linear density given

$$\text{by } \mu(x) = 0.650 \frac{\text{kg}}{\text{m}^3} x^2 .$$

In order to be able to determine the position of the center of mass of a rod with a given length and a given linear density as a function of position, you first need to be able to find the mass of such a rod. To do that, one might be tempted to use a method that works only for the special case of a uniform rod, namely, to try using $m = \mu L$ with L being the length of the rod. The problem with this is, that μ varies along the entire length of the rod. What value would one use for μ ? One might be tempted to evaluate the given μ at $x = L$ and use that, but that would be acting as if the linear density were constant at $\mu = \mu(L)$. It is not. In fact, in the case at hand, $\mu(L)$ is the maximum linear density of the rod, it only has that value at one point on the rod.

What we can do is to say that the infinitesimal amount of mass dm in a segment dx of the rod is μdx . Here we are saying that at some position x on the rod, the amount of mass in the infinitesimal length dx of the rod is the value of μ at that x value, times the infinitesimal length dx . Here we don't have to worry about the fact that μ changes with position since the segment dx is infinitesimally long, meaning, essentially, that it has zero length, so the whole segment is essentially at one position x and hence the value of μ at that x is good for the whole segment dx .

$$dm = \mu(x) dx \quad (22-2)$$

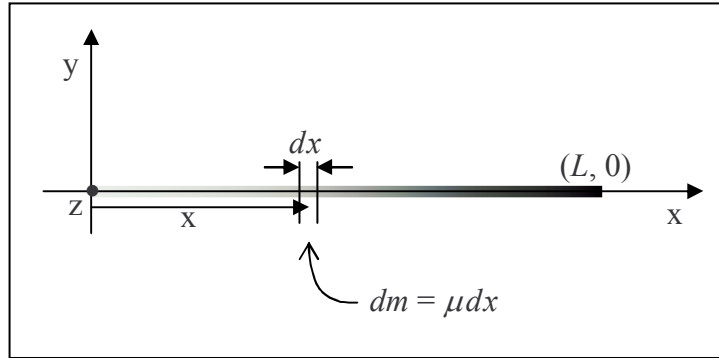

Now this is true for any value of x , but it just covers an infinitesimal segment of the rod at x . To get the mass of the whole rod, we need to add up all such contributions to the mass. Of course, since each dm corresponds to an infinitesimal length of the rod, we will have an infinite number of terms in the sum of all the dm 's. An infinite sum of infinitesimal terms, is an integral.

$$\int dm = \int_0^L \mu(x) dx \quad (22-3)$$

where the values of x have to run from 0 to L to cover the length of the rod, hence the limits on the right. Now the mathematicians have provided us with a rich set of algorithms for evaluating integrals, and indeed we will have to reach into that toolbox to evaluate the integral on the right, but to evaluate the integral on the left, we cannot, should not, and will not turn to such an algorithm. Instead, we use common sense and our conceptual understanding of what the integral on the left means. In the context of the problem at hand, $\int dm$ means “the sum of all the infinitesimal bits of mass making up the rod.” Now, if you add up all the infinitesimal bits of mass making up the rod, you get the mass of the rod. So $\int dm$ is just the mass of the rod, which we will call m . Equation 22-3 then becomes

$$m = \int_0^L \mu(x) dx \quad (22-4)$$

Replacing $\mu(x)$ with the given expression for the linear density $\mu = 0.650 \frac{\text{kg}}{\text{m}^3} x^2$ which I choose to write as $\mu = bx^2$ with b being defined by $b \equiv 0.650 \frac{\text{kg}}{\text{m}^3}$ we obtain

$$m = \int_0^L bx^2 dx$$

Factoring out the constant yields

$$m = b \int_0^L x^2 dx$$

When integrating the variable of integration raised to a power all we have to do is increase the power by one and divide by the new power. This gives

$$m = b \frac{x^3}{3} \Big|_0^L$$

Evaluating this at the lower and upper limits yields

$$m = b \left(\frac{L^3}{3} - \frac{0^3}{3} \right)$$

$$m = b \left(\frac{L^3}{3} - \frac{0^3}{3} \right)$$

$$m = \frac{bL^3}{3}$$

The value of L is given as 0.890 m and we defined b to be the constant $0.650 \frac{\text{kg}}{\text{m}^3}$ in the given expression for μ , $\mu = 0.650 \frac{\text{kg}}{\text{m}^3} x^2$, so

$$m = \frac{0.650 \frac{\text{kg}}{\text{m}^3} (0.890 \text{ m})^3}{3}$$

$$m = 0.1527 \text{ kg}$$

That's a value that will come in handy when we calculate the position of the center of mass.

Now, when we calculated the center of mass of a set of discrete particles (where a discrete particle is one that is by itself, as opposed, for instance, to being part of a rigid body) we just carried out a weighted sum in which each term was the position of a particle times its weighting factor and the weighting factor was that fraction, of the total mass, represented by the mass of the particle. We carry out a similar procedure for a continuous distribution of mass such as that which makes up the rod in question. Let's start by writing one single term of the sum. We'll consider an infinitesimal length dx of the rod at a position x along the length of the rod. The position, as just stated, is x , and the weighting factor is that fraction of the total mass m of the rod

that the mass dm of the infinitesimal length dx represents. That means the weighting factor is $\frac{dm}{m}$, so, a term in our weighted sum of positions looks like:

$$\frac{dm}{m} x$$

Now, dm can be expressed as μdx so our expression for the term in the weighted sum can be written as

$$\frac{\mu dx}{m} x$$

That's one term in the weighted sum of positions, the sum that yields the position of the center of mass. The thing is, because the value of x is unspecified, that one term is good for any infinitesimal segment of the bar. Every term in the sum looks just like that one. So we have an expression for every term in the sum. Of course, because the expression is for an infinitesimal length dx of the rod, there will be an infinite number of terms in the sum. So, again we have an infinite sum of infinitesimal terms. That is, again we have an integral. Our expression for the position of the center of mass is:

$$\bar{x} = \int_0^L \frac{\mu dx}{m} x$$

Substituting the given expression $\mu(x) = 0.650 \frac{\text{kg}}{\text{m}^3} x^2$ for μ , which we again write as $\mu = bx^2$ with b being defined by $b \equiv 0.650 \frac{\text{kg}}{\text{m}^3}$, yields

$$\bar{x} = \int_0^L \frac{bx^2 dx}{m} x$$

Rearranging and factoring the constants out gives

$$\bar{x} = \frac{b}{m} \int_0^L x^3 dx$$

Next we carry out the integration.

$$\bar{x} = \frac{b}{m} \frac{x^4}{4} \Big|_0^L$$

$$\bar{x} = \frac{b}{m} \left(\frac{L^4}{4} - \frac{0^4}{4} \right)$$

$$\bar{x} = \frac{bL^4}{4m}$$

Now we substitute values with units; the mass m of the rod that we found earlier, the constant b that we defined to simplify the appearance of the linear density function, and the given length L of the rod:

$$\bar{x} = \frac{\left(0.650 \frac{\text{kg}}{\text{m}^3} \right) (0.890 \text{ m})^4}{4(0.1527 \text{ kg})}$$

$$\bar{x} = 0.668 \text{ m}$$

This is our final answer for the position of the center of mass. Note that it is closer to the denser end of the rod, as we would expect. The reader may also be interested to note that had we

substituted the expression $m = \frac{bL^3}{3}$ that we derived for the mass, rather than the value we

obtained when we evaluated that expression, our expression for \bar{x} would have simplified to $\frac{3}{4}L$

which evaluates to $\bar{x} = 0.668 \text{ m}$, the same result as the one above.

Moment of Inertia—a.k.a. Rotational Inertia

You already know that the moment of inertia of a rigid object, with respect to a specified axis of rotation, depends on the mass of that object, and how that mass is distributed relative to the axis of rotation. In fact, you know that if the mass is packed in close to the axis of rotation, the object will have a smaller moment of inertia than it would if the same mass was more spread out relative to the axis of rotation. Let's quantify these ideas. (Quantify, in this context, means to put into equation form.)

We start by constructing, in our minds, an idealized object for which the mass is all concentrated at a single location which is not on the axis of rotation: Imagine a massless disk rotating with angular velocity ω about an axis through the center of the disk and perpendicular to its faces. Let there be a particle of mass m embedded in the disk at a distance r from the axis of rotation. Here's what it looks like from a viewpoint on the axis of rotation, some distance away from the disk:

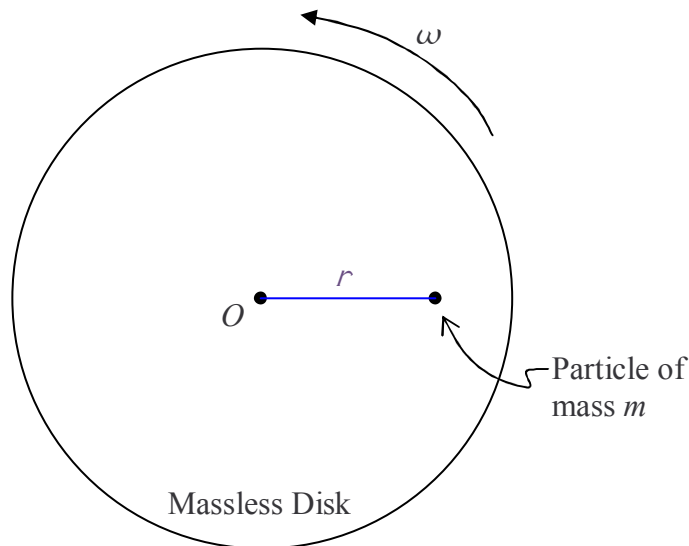

where the axis of rotation is marked with an O . Because the disk is massless, we call the moment of inertia of the construction, the moment of inertia of a particle, with respect to rotation about an axis from which the particle is a distance r .

Knowing that the velocity of the particle can be expressed as $v = r\omega$ you can show yourself how I must be defined in order for the kinetic energy expression $K = \frac{1}{2}I\omega^2$ for the object, viewed as a spinning rigid body, to be the same as the kinetic energy expression $K = \frac{1}{2}mv^2$ for the particle moving through space in a circle. Either point of view is valid so both viewpoints must yield the same kinetic energy. Please go ahead and derive what I must be and then come back and read the derivation below.

Here is the derivation:

Given that $K = \frac{1}{2}mv^2$, we replace v with $r\omega$. This gives $K = \frac{1}{2}m(r\omega)^2$ which can be written as

$$K = \frac{1}{2}(mr^2)\omega^2$$

For this to be equivalent to

$$K = \frac{1}{2}I\omega^2$$

we must have

$$\boxed{I = mr^2} \quad (22-5)$$

This is our result for the moment of inertia of a particle of mass m , with respect to an axis of rotation from which the particle is a distance r .

Now suppose we have two particles embedded in our massless disk, one of mass m_1 at a distance r_1 from the axis of rotation and another of mass m_2 at a distance r_2 from the axis of rotation.

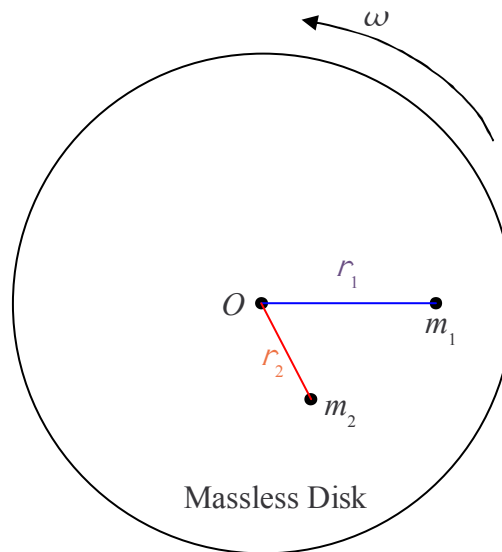

The moment of inertia of the first one by itself would be

$$I_1 = m_1 r_1^2$$

and the moment of inertia of the second particle by itself would be

$$I_2 = m_2 r_2^2$$

The total moment of inertia of the two particles embedded in the massless disk is simply the sum of the two individual moments of inertia.

$$I = I_1 + I_2$$

$$I = m_1 r_1^2 + m_2 r_2^2$$

This concept can be extended to include any number of particles. For each additional particle, one simply includes another $m_i r_i^2$ term in the sum where m_i is the mass of the additional particle and r_i is the distance that the additional particle is from the axis of rotation. In the case of a rigid object, we subdivide the object up into an infinite set of infinitesimal mass elements dm . Each mass element contributes an amount of moment of inertia

$$dI = r^2 dm \quad (22-6)$$

to the moment of inertia of the object, where r is the distance that the particular mass element is from the axis of rotation.

Example 22-2

Find the moment of inertia of the rod in Example 22-1 with respect to rotation about the z axis.

In Example 22-1, the linear density of the rod was given as $\mu = 0.650 \frac{\text{kg}}{\text{m}^3} x^2$. To reduce the number of times we have to write the value in that expression, we will write it as $\mu = bx^2$ with b being defined as $b \equiv 0.650 \frac{\text{kg}}{\text{m}^3}$.

The total moment of inertia of the rod is the infinite sum of the infinitesimal contributions

$$dI = r^2 dm \quad (22-6)$$

from each and every mass element dm making up the rod.

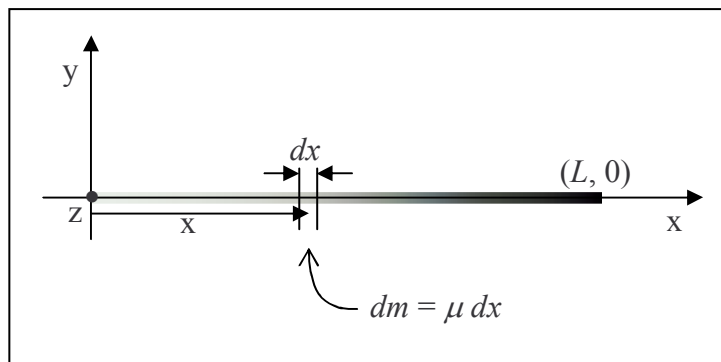

In the diagram, we have indicated an infinitesimal element dx of the rod at an arbitrary position on the rod. The z axis, the axis of rotation, looks like a dot in the diagram and the distance r in $dI = r^2 dm$, the distance that the bit of mass under consideration is from the axis of rotation, is simply the abscissa x of the position of the mass element. Hence, equation 22-6 for the case at hand can be written as

$$dI = x^2 dm$$

which we copy here

$$dI = x^2 dm$$

By definition of the linear mass density μ , the infinitesimal mass dm can be expressed as $dm = \mu dx$. Substituting this into our expression for dI yields

$$dI = x^2 \mu dx$$

Now μ was given as bx^2 (with b actually being the symbol that I chose to use to represent the given constant $0.650 \frac{\text{kg}}{\text{m}^3}$). Substituting bx^2 in for μ in our expression for dI yields

$$dI = x^2 (bx^2) dx$$

$$dI = bx^4 dx$$

This expression for the contribution of an element dx of the rod to the total moment of inertia of the rod is good for every element dx of the rod. The infinite sum of all such infinitesimal contributions is thus the integral

$$\int dI = \int_0^L bx^4 dx$$

Again, as with our last integration, on the left, we have not bothered with limits of integration—the infinite sum of all the infinitesimal contributions to the moment of inertia is simply the total moment of inertia.

$$I = \int_0^L bx^4 dx$$

On the right we use the limits of integration 0 to L to include every element of the rod which extends from $x = 0$ to $x = L$, with L given as 0.890 m. Factoring out the constant b gives us

$$I = b \int_0^L x^4 dx$$

Now we carry out the integration:

$$I = b \frac{x^5}{5} \Big|_0^L$$

$$I = b \left(\frac{L^5}{5} - \frac{0^5}{5} \right)$$

$$I = b \frac{L^5}{5}$$

Substituting the given values of b and L yields:

$$I = 0.650 \frac{\text{kg} (0.890 \text{ m})^5}{\text{m}^3 \cdot 5}$$

$$I = 0.0726 \text{ kg} \cdot \text{m}^2$$

The Parallel Axis Theorem

We state, without proof, the parallel axis theorem:

$$I = I_{\text{CM}} + md^2 \quad (22-7)$$

in which:

I is the moment of inertia of an object with respect to an axis from which the center of mass of the object is a distance d .

I_{CM} is the moment of inertia of the object with respect to an axis that is parallel to the first axis and passes through the center of mass.

m is the mass of the object.

d is the distance between the two axes.

The parallel axis theorem relates the moment of inertia I_{CM} of an object, with respect to an axis through the center of mass of the object, to the moment of inertia I of the same object, with respect to an axis that is parallel to the axis through the center of mass and is at a distance d from the axis through the center of mass.

A conceptual statement made by the parallel axis theorem is one that you probably could have arrived at by means of common sense, namely that the moment of inertia of an object with respect to an axis through the center of mass is smaller than the moment of inertia about any axis parallel to that one. As you know, the closer the mass is “packed” to the axis of rotation, the smaller the moment of inertia; and, for a given object, per definition of the center of mass, the mass is packed most closely to the axis of rotation when the axis of rotation passes through the center of mass.

Example 22-3

Find the moment of inertia of the rod from examples 22-1 and 22-2, with respect to an axis that is perpendicular to the rod and passes through the center of mass of the rod.

Recall that the rod in question extends along the x axis from $x = 0$ to $x = L$ with $L = 0.890$ m and that the rod has a linear density given by $\mu = bL^2$ with $b \equiv 0.650 \frac{\text{kg}}{\text{m}^3}$.

The axis in question can be chosen to be one that is parallel to the z axis, the axis about which, in solving example 22-2, we found the moment of inertia to be $I = 0.0726 \text{ kg} \cdot \text{m}^2$. In solving example 22-1 we found the mass of the rod to be $m = 0.1527$ kg and the center of mass of the rod to be at a distance $d = 0.668$ m away from the z axis. Here we present the solution to the problem:

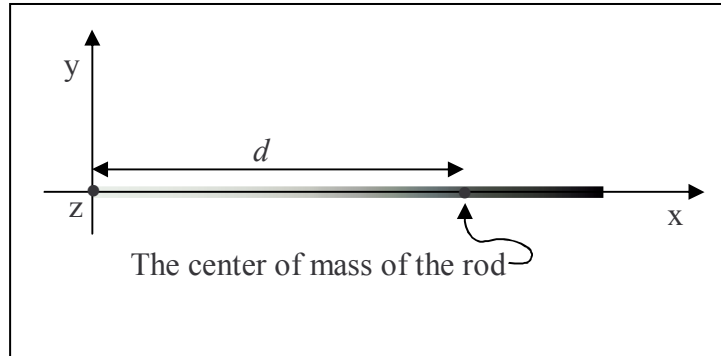

$$I = I_{\text{CM}} + m d^2$$

$$I_{\text{CM}} = I - m d^2$$

$$I_{\text{CM}} = 0.0726 \text{ kg} \cdot \text{m}^2 - 0.1527 \text{ kg} (0.668 \text{ m})^2$$

$$I_{\text{CM}} = 0.0047 \text{ kg} \cdot \text{m}^2$$

23 Statics

*It bears repeating: Make sure that any force that enters the torque equilibrium equation is multiplied by a moment arm, and that any pure torque (such as τ_o in the solution of example 23-2 on page 151) that enters the torque equilibrium equation is **NOT** multiplied by a moment arm.*

For any rigid body, at any instant in time, Newton's 2nd Law for translational motion

$$\vec{a} = \frac{1}{m} \sum \vec{F}$$

and Newton's 2nd Law for Rotational motion

$$\vec{\alpha} = \frac{1}{I} \sum \vec{\tau}$$

both apply. In this chapter we focus on rigid bodies that are in equilibrium. This topic, the study of objects in equilibrium, is referred to as *statics*. Being in equilibrium means that the acceleration and the angular acceleration of the rigid body in question are both zero. When $\vec{a} = 0$, Newton's 2nd Law for translational motion boils down to

$$\sum \vec{F} = 0 \quad (23-1)$$

and when $\vec{\alpha} = 0$, Newton's 2nd Law for Rotational motion becomes

$$\sum \vec{\tau} = 0 \quad (23-2)$$

These two vector equations are called the equilibrium equations. They are also known as the equilibrium conditions. In that each of the vectors has three components, the two vector equations actually represent a set of six scalar equations:

$$\sum F_x = 0$$

$$\sum F_y = 0$$

$$\sum F_z = 0$$

$$\sum \tau_{xy} = 0$$

$$\sum \tau_{yz} = 0$$

$$\sum \tau_{zx} = 0$$

In many cases, all the forces lie in one and the same plane, and if there are any torques aside from the torques resulting from the forces, those torques are about an axis perpendicular to that plane. If we define the plane in which the forces lie to be the x-y plane, then for such cases, the set of six scalar equations reduces to a set of 3 scalar equations (in that the other 3 are trivial $0=0$ identities):

$$\sum F_x = 0 \quad (23-3)$$

$$\sum F_y = 0 \quad (23-4)$$

$$\sum \tau_z = 0 \quad (23-5)$$

Statics problems represent a subset of Newton's 2nd Law problems. You already know how to solve Newton's 2nd Law problems so there is not much new for you to learn here, but a couple of details regarding the way in which objects are supported will be useful to you.

Many statics problems involve beams and columns. Beams and columns are referred to collectively as members. The analysis of the equilibrium of a member typically entails some approximations which involve the neglect of some short distances. As long as these distances are small compared to the length of the beam, the approximations are very good. One of these approximations is that, unless otherwise specified, we neglect the dimensions of the cross section of the member (for instance, the width and height of a beam). We do not neglect the length of the member.

Pin-Connected Members

A pin is a short axle. A member which is pin-connected at one end, is free to rotate about the pin. The pin is perpendicular to the direction in which the member extends. In practice, in the case of a member that is pin-connected at one end, the pin is not really right at the end of the member, but unless the distance from the pin to the end (the end that is very near the pin) of the member is specified, we neglect that distance. Also, the mechanism by which a beam is pin-connected to, for instance, a wall, causes the end of the beam to be a short distance from the wall. Unless otherwise specified, we are supposed to neglect this distance as well. A pin exerts a force on the member. The force lies in the plane that contains the member and is perpendicular to the pin. Beyond that, the direction of the force, initially, is unknown. On a free body diagram of the member, one can include the pin force as an unknown force at an unknown angle, or one can include the unknown x and y components of the pin force.

Example 23-1

One end of a beam of mass 6.92 kg and of length 2.00 m is pin-connected to a wall. The other end of the beam rests on a frictionless floor at a point that is 1.80 m away from the wall. The beam is in a plane that is perpendicular to both the wall and the floor. The pin is perpendicular to that plane. Find the force exerted by the pin on the beam, and find the normal force exerted on the beam by the floor.

Solution

First let's draw a sketch:

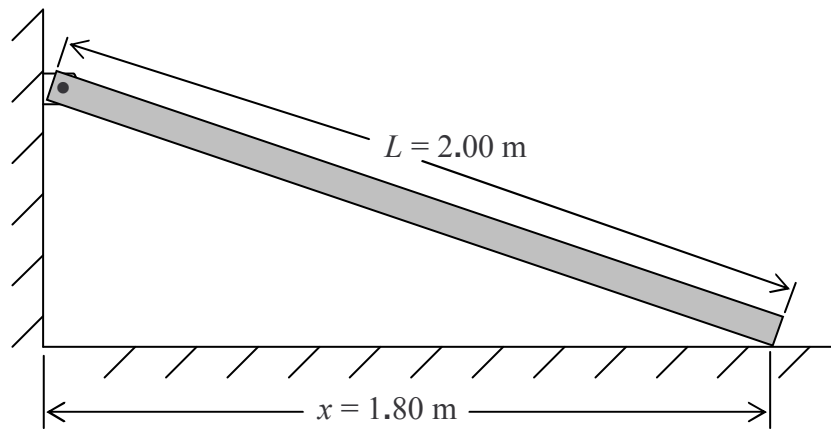

Now we draw a free body diagram of the member:

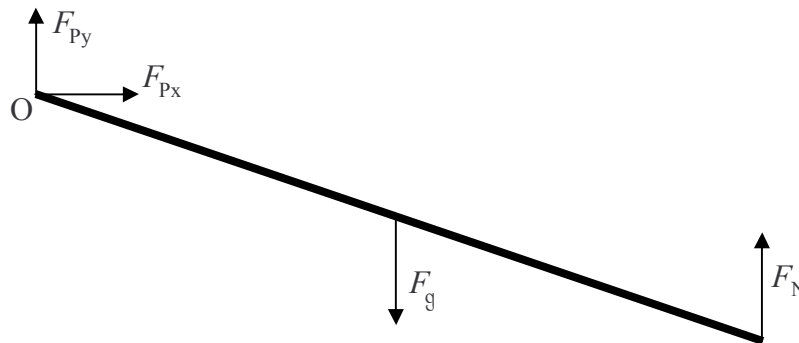

We are going to need to apply the torque equilibrium condition to the beam so I am going to add moment arms to the diagram. My plan is to sum the torques about point O so I will depict moment arms with respect to an axis through point O.

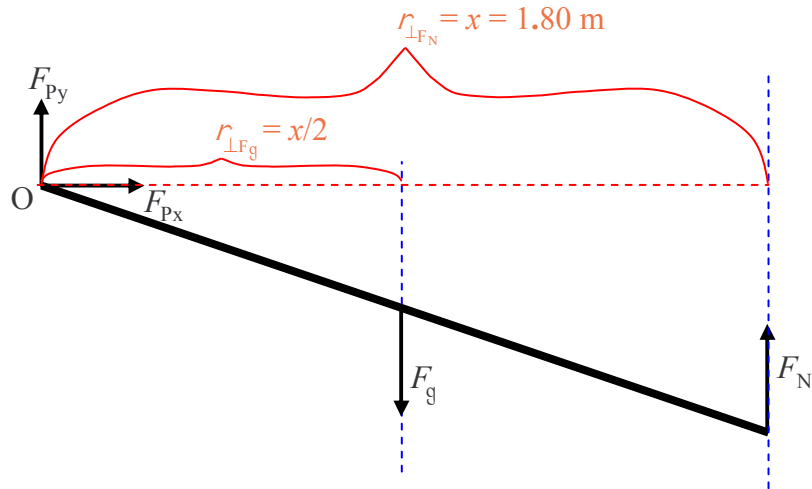

Now let's apply the equilibrium conditions:

$$\sum F_{\rightarrow} = 0$$

$$F_{Px} = 0$$

There are three unknown force values depicted in the free body diagram and we have already found one of them! Let's apply another equilibrium condition:

$$\sum F_{\uparrow} = 0$$

$$F_{Py} - F_g + F_N = 0$$

$$F_{Py} - mg + F_N = 0 \quad (23-6)$$

There are two unknowns in this equation. We can't solve it but it may prove useful later on. Let's apply the torque equilibrium condition.

$$\sum \tau_{Oy} = 0$$

$$-\frac{x}{2}F_g + xF_N = 0$$

$$-\frac{x}{2}mg + xF_N = 0$$

Here, I copy that last line for you before proceeding:

$$-\frac{x}{2}mg + xF_N = 0$$

$$F_N = \frac{mg}{2}$$

$$F_N = \frac{6.92 \text{ kg} (9.80 \text{ newtons/kg})}{2}$$

$$F_N = 32.9 \text{ newtons}$$

We can use this result ($F_N = \frac{mg}{2}$) in equation 23-6 (the one that reads $F_{py} - mg + F_N = 0$) to obtain a value for F_{py} :

$$F_{py} - mg + F_N = 0$$

$$F_{py} = mg - F_N$$

$$F_{py} = mg - \frac{mg}{2}$$

$$F_{py} = \frac{mg}{2}$$

$$F_{py} = \frac{6.92 \text{ kg} (9.80 \text{ newtons/kg})}{2}$$

$$F_{py} = 32.9 \text{ newtons}$$

Recalling that we found F_{px} to be zero, we can write, for our final answer:

$\vec{F}_p = 32.9 \text{ newtons, straight upward}$ and $\vec{F}_N = 32.9 \text{ newtons, straight upward}$

Fix-Connected Members

A fix-connected member is one that is rigidly attached to a structure (such as a wall) that is external to the object whose equilibrium is under study. An example would be a metal rod, one end of which is welded to a metal wall. A fixed connection can apply a force in any direction, and it can apply a torque in any direction. When all the other forces lie in a plane, the force applied by the fixed connection will be in that plane. When all the other torques are along or parallel to a particular line, then the torque exerted by the fixed connection will be along or parallel to that same line.

Example 23-2

A horizontal bar of length L and mass m is fix connected to a wall. Find the force and the torque exerted on the bar by the wall.

Solution

First a sketch:

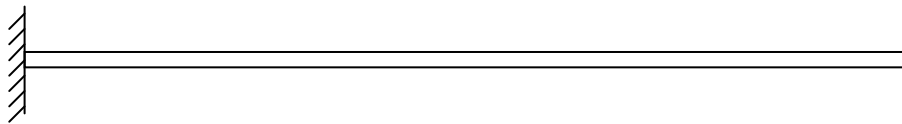

then a free body diagram:

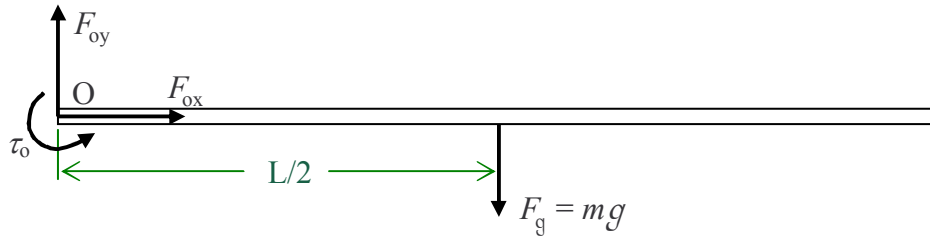

followed by the application of the equilibrium conditions to the free body diagram:

$$\sum F_{\rightarrow} = 0$$

$$F_{\text{ox}} = 0$$

That was quick. Let's see what setting the sum of the vertical forces equal to zero yields:

$$\sum F_{\uparrow} = 0$$

$$F_{\text{oy}} - F_{\text{g}} = 0$$

$$F_{\text{oy}} = F_{\text{g}}$$

$$F_{\text{oy}} = mg$$

Now for the torque equilibrium condition:

$$\sum \tau_{\text{Oy}} = 0$$

$$\tau_{\text{o}} - \frac{L}{2} F_{\text{g}} = 0$$

$$\tau_{\text{o}} - \frac{L}{2} mg = 0$$

$$\tau_{\text{o}} = \frac{1}{2} mgL$$

The wall exerts an upward force of magnitude mg , and a counterclockwise (as viewed from that position for which the free end of the bar is to the right) torque of magnitude $\frac{1}{2}mgL$ on the bar.

24 Work and Energy

You have done quite a bit of problem solving using energy concepts. Back in chapter 2 we defined energy as a transferable physical quantity that an object can be said to have and we said that if one transfers energy to a material particle that is initially at rest, that particle acquires a speed which is an indicator of how much energy was transferred. We said that an object can have energy because it is moving (kinetic energy), or due to its position relative to some other object (potential energy)¹. We said that energy has units of joules. You have dealt with translational kinetic energy $K = \frac{1}{2} m v^2$, rotational kinetic energy $K = \frac{1}{2} I \omega^2$, spring potential energy $U = \frac{1}{2} k x^2$, near-earth's-surface gravitational potential energy $U = m g y$, and the

universal gravitational potential energy $U = -\frac{G m_1 m_2}{r}$ corresponding to the Universal Law of

Gravitation. The principle of the conservation of energy is, in the opinion of this author, the central most important concept in physics. Indeed, at least one dictionary defines physics as the study of energy. It is important because it is conserved and the principle of conservation of energy allows us to use simple accounting procedures to make predictions about the outcomes of physical processes that have yet to occur and to understand processes that have already occurred. According to the principle of conservation of energy, any change in the total amount of energy of a system can be accounted for in terms of energy transferred from the immediate surroundings to the system or to the immediate surroundings from the system. Physicists recognize two categories of energy transfer processes. One is called work and the other is called heat flow. In this chapter we focus our attention on work.

Conceptually, positive work is what you are doing on an object when you push or pull on it in the same direction in which the object is moving. You do negative work on an object when you push or pull on it in the direction opposite the direction in which the object is going. The mnemonic for remembering the definition of work that helps you remember how to calculate it is “Work is Force times Distance.” The mnemonic does not tell the whole story. It is good for the case of a constant force acting on an object that moves on a straight line path when the force is in the same exact direction as the direction of motion.

A more general, but still not completely general, “how-to-calculate-it” definition of work applies to the case of a constant force acting on an object that moves along a straight line path (when the force is not necessarily directed along the path). In such a case, the work W done on the object, when it travels a certain distance along the path, is: the along-the-path component of the force F_{\parallel} times the length of the path segment Δr :

$$W = F_{\parallel} \Delta r \quad (24-1)$$

Even this case still needs some additional clarification: If the force component vector along the path is in the same direction as the object's displacement vector, then F_{\parallel} is positive, so the work is positive; but if the force component vector along the path is in the opposite direction to that of

¹ As mentioned before, the potential energy is actually the energy of the system of the objects and their fields as a whole, but it is common to assign it to part of the system for “bookkeeping” purposes as I do in this book.

the object's displacement vector, then F_{\parallel} is negative, so the work is negative. Thus, if you are pushing or pulling on an object in a direction that would tend to make it speed up, you are doing positive work on the object. But if you are pushing or pulling on an object in a direction that would tend to slow it down, you are doing negative work on the object.

In the most general case in which the “component of the force along the path” is continually changing because the force is continually changing (such as in the case of an object on the end of a spring) or because the path is not straight, our “how-to-calculate-it” definition of the work becomes: For each infinitesimal path segment making up the path in question, we take the product of the along-the-path force component and the infinitesimal length of the path segment. The work is the sum of all such products. Such a sum would have an infinite number of terms. We refer to such a sum as an integral.

The Relation Between Work and Motion

Let's go back to the simplest case, the case in which a force \vec{F} is the only force acting on a particle of mass m which moves a distance Δr (while the force is acting on it) in a straight line in the exact same direction as the force. The plan here is to investigate the connection between the work on the particle and the motion of the particle. We'll start with Newton's 2nd Law.

Free Body Diagram

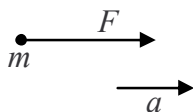

$$a_{\rightarrow} = \frac{1}{m} \sum F_{\rightarrow}$$

$$a = \frac{1}{m} F$$

Solving for F , we arrive at:

$$F = m a$$

On the left, we have the magnitude of the force. If we multiply that by the distance Δr , we get the work done by the force on the particle as it moves the distance Δr along the path, in the same direction as the force. If we multiply the left side of the equation by Δr then we have to multiply the right by the same thing to maintain the equality.

$$F \Delta r = m a \Delta r$$

On the left we have the work W , so:

$$W = m a \Delta r$$

On the right we have two quantities used to characterize the motion of a particle so we have certainly met our goal of relating work to motion, but we can untangle things on the right a bit if we recognize that, since we have a constant force, we must have a constant acceleration. This means the constant acceleration equations apply, in particular, the one that (in terms of r rather than x) reads:

$$v^2 = v_0^2 + 2a\Delta r$$

Solving this for $a\Delta r$ gives

$$a\Delta r = \frac{1}{2}v^2 - \frac{1}{2}v_0^2$$

Substituting this into our expression for W above (the one that reads $W = m a \Delta r$) we obtain

$$W = m \left(\frac{1}{2}v^2 - \frac{1}{2}v_0^2 \right)$$

which can be written as

$$W = \frac{1}{2}m v^2 - \frac{1}{2}m v_0^2$$

Of course we recognize the $\frac{1}{2}m v_0^2$ as the kinetic energy of the particle before the work is done

on the particle and the $\frac{1}{2}m v^2$ as the kinetic energy of the particle after the work is done on it.

To be consistent with the notation we used in our early discussion of the conservation of mechanical energy we change to the notation in which the prime symbol (') signifies “after” and no super- or subscript at all (rather than the subscript “o”) represents “before.” Using this notation and the definition of kinetic energy, our expression for W becomes:

$$W = K' - K$$

Since the “after” kinetic energy minus the “before” kinetic energy is just the change in kinetic energy ΔK , we can write the expression for W as:

$$W = \Delta K \tag{24-2}$$

This is indeed a simple relation between work and motion. The cause, work on a particle, on the left, is exactly equal to the effect, a change in the kinetic energy of the particle. This result is so important that we give it a name, it is the *Work-Energy Relation*. It also goes by the name: *The Work-Energy Principle*. It works for extended rigid bodies as well. In the case of a rigid body that rotates, it is the displacement of the point of application of the force, along the path of said point of application, that is used (as the Δr) in calculating the work done on the object.

In the expression $W = \Delta K$, the work is the net work (the total work) done by all the forces acting on the particle or rigid body. The net work can be calculated by finding the work done by each force and adding the results, or by finding the net force and using it in the definition of the work.

Calculating the Work as the Force-Along-the-Path Times the Length of the Path

Consider a block on a flat frictionless incline that makes an angle θ with the vertical. The block travels from a point A near the top of the incline to a point B, a distance d in the down-the-incline direction from A. Find the work done, by the gravitational force, on the block.

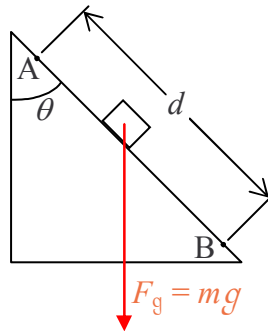

We've drawn a sketch of the situation (not a free body diagram). We note that the force for which we are supposed to calculate the work is not along the path. So, we define a coordinate system with one axis in the down-the-incline direction and the other perpendicular to that axis

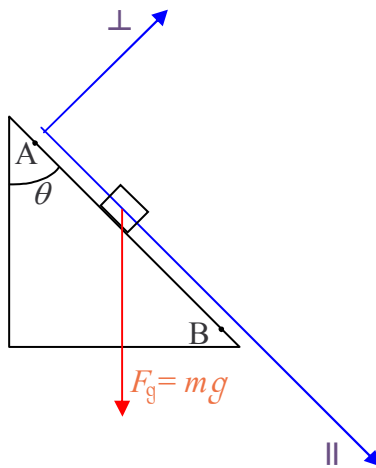

and break the gravitational force vector up into its components with respect to that coordinate system.

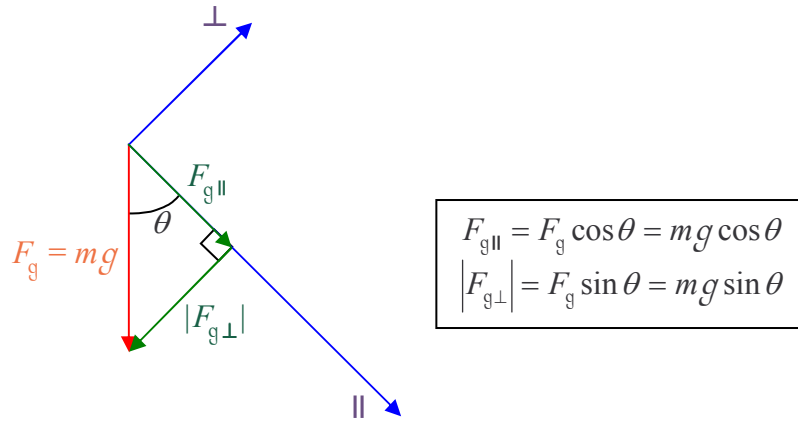

Now we redraw the sketch with the gravitational force replaced by its components:

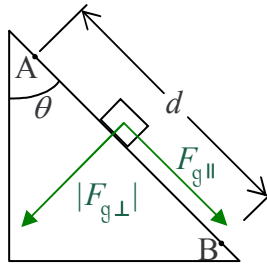

$F_{g\perp}$, being perpendicular to the path does no work on the block as the block moves from A to B. The work done by the gravitational force is given by

$$W = F_{\parallel} d$$

$$W = F_{g\parallel} d$$

$$W = mg(\cos \theta) d$$

$$W = mgd \cos \theta$$

While this method for calculating the work done by a force is perfectly valid, there is an easier way. It involves another product operator for vectors (besides the cross product), called the *dot product*. To use it, we need to recognize that the length of the path, combined with the direction of motion, is none other than the displacement vector (for the point of application of the force). Then we just need to find the dot product of the force vector and the displacement vector.

The Dot Product of Two Vectors

The dot product of the vectors \vec{A} and \vec{B} is written $\vec{A} \cdot \vec{B}$ and is expressed as:

$$\vec{A} \cdot \vec{B} = AB \cos \theta \quad (24-3)$$

where θ , just as in the case of the cross product, is the angle between the two vectors after they have been placed tail to tail.

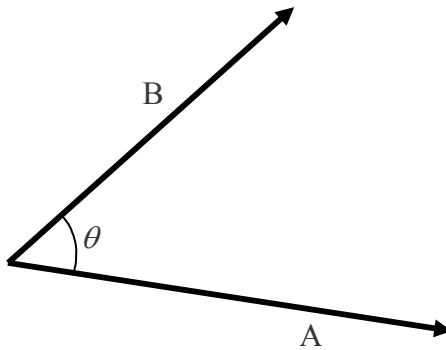

The dot product can be interpreted as either $A_{\parallel}B$ (the component of \vec{A} along \vec{B} , times, the magnitude of \vec{B}) or $B_{\parallel}A$ (the component of \vec{B} along \vec{A} , times, the magnitude of \vec{A}), both of which evaluate to one and the same value. This makes the dot product perfect for calculating the work. Since $\vec{F} \cdot \Delta\vec{r} = F_{\parallel}\Delta r$ and $F_{\parallel}\Delta r$ is W , we have

$$W = \vec{F} \cdot \Delta\vec{r} \quad (24-4)$$

By means of the dot product, we can solve the example in the last section much more quickly than we did before.

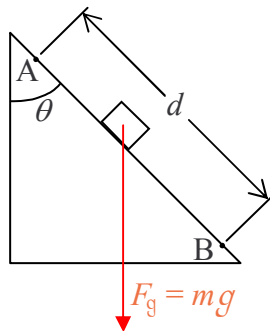

Find the work done on the block by the gravitational force when the object moves from point A to Point B.

We define the displacement vector \vec{d} to have a magnitude equal to the distance from point A to point B with a direction the same as the direction of motion (the down-the-ramp direction).

Using our definition of work as the dot product of the force and the displacement, equation 24-4:

$$W = \vec{F} \cdot \vec{\Delta r}$$

with the gravitational force vector \vec{F}_g being the force, and \vec{d} being the displacement, the work can be written as:

$$W = \vec{F}_g \cdot \vec{d}.$$

Using the definition of the dot product we find that:

$$W = F_g d \cos \theta.$$

Replacing the magnitude of the gravitational force with mg we arrive at our final answer:

$$W = mgd \cos \theta.$$

This is the same answer that we got prior to our discussion of the dot product.

In cases in which the force and the displacement vectors are given in \hat{i} , \hat{j} , \hat{k} notation, finding the work is straightforward.

The Dot Product in Unit Vector Notation

The simple dot product relations among the unit vectors makes it easy to evaluate the dot product of two vectors expressed in unit vector notation. From what amounts to our definition of the dot product, equation 24-3:

$$\vec{A} \cdot \vec{B} = AB \cos \theta$$

we note that a vector dotted into itself is simply the square of the magnitude of the vector. This is true because the angle between a vector and itself is 0° and $\cos 0^\circ$ is 1.

$$\vec{A} \cdot \vec{A} = AA \cos 0^\circ = A^2$$

Since the unit vectors all have magnitude 1, any unit vector dotted into itself yields $(1)^2$ which is just 1.

$$\hat{i} \cdot \hat{i} = 1, \quad \hat{j} \cdot \hat{j} = 1, \quad \text{and} \quad \hat{k} \cdot \hat{k} = 1$$

Now the angle between any two different Cartesian coordinate axis unit vectors is 90° and the $\cos 90^\circ$ is 0. Thus, the dot product of any Cartesian coordinate axis unit vector into any other Cartesian coordinate axis unit vector is zero.

So, if

$$\vec{\mathbf{A}} = A_x \hat{\mathbf{i}} + A_y \hat{\mathbf{j}} + A_z \hat{\mathbf{k}}$$

and

$$\vec{\mathbf{B}} = B_x \hat{\mathbf{i}} + B_y \hat{\mathbf{j}} + B_z \hat{\mathbf{k}}$$

then $\vec{\mathbf{A}} \cdot \vec{\mathbf{B}}$ is just

$$\vec{\mathbf{A}} \cdot \vec{\mathbf{B}} = (A_x \hat{\mathbf{i}} + A_y \hat{\mathbf{j}} + A_z \hat{\mathbf{k}}) \cdot (B_x \hat{\mathbf{i}} + B_y \hat{\mathbf{j}} + B_z \hat{\mathbf{k}})$$

$$\begin{aligned} \vec{\mathbf{A}} \cdot \vec{\mathbf{B}} &= A_x \hat{\mathbf{i}} \cdot (B_x \hat{\mathbf{i}} + B_y \hat{\mathbf{j}} + B_z \hat{\mathbf{k}}) + \\ &A_y \hat{\mathbf{j}} \cdot (B_x \hat{\mathbf{i}} + B_y \hat{\mathbf{j}} + B_z \hat{\mathbf{k}}) + \\ &A_z \hat{\mathbf{k}} \cdot (B_x \hat{\mathbf{i}} + B_y \hat{\mathbf{j}} + B_z \hat{\mathbf{k}}) \end{aligned}$$

$$\begin{aligned} \vec{\mathbf{A}} \cdot \vec{\mathbf{B}} &= A_x \hat{\mathbf{i}} \cdot B_x \hat{\mathbf{i}} + A_x \hat{\mathbf{i}} \cdot B_y \hat{\mathbf{j}} + A_x \hat{\mathbf{i}} \cdot B_z \hat{\mathbf{k}} + \\ &A_y \hat{\mathbf{j}} \cdot B_x \hat{\mathbf{i}} + A_y \hat{\mathbf{j}} \cdot B_y \hat{\mathbf{j}} + A_y \hat{\mathbf{j}} \cdot B_z \hat{\mathbf{k}} + \\ &A_z \hat{\mathbf{k}} \cdot B_x \hat{\mathbf{i}} + A_z \hat{\mathbf{k}} \cdot B_y \hat{\mathbf{j}} + A_z \hat{\mathbf{k}} \cdot B_z \hat{\mathbf{k}} \end{aligned}$$

$$\begin{aligned} \vec{\mathbf{A}} \cdot \vec{\mathbf{B}} &= A_x B_x \hat{\mathbf{i}} \cdot \hat{\mathbf{i}} + A_x B_y \hat{\mathbf{i}} \cdot \hat{\mathbf{j}} + A_x B_z \hat{\mathbf{i}} \cdot \hat{\mathbf{k}} + \\ &A_y B_x \hat{\mathbf{j}} \cdot \hat{\mathbf{i}} + A_y B_y \hat{\mathbf{j}} \cdot \hat{\mathbf{j}} + A_y B_z \hat{\mathbf{j}} \cdot \hat{\mathbf{k}} + \\ &A_z B_x \hat{\mathbf{k}} \cdot \hat{\mathbf{i}} + A_z B_y \hat{\mathbf{k}} \cdot \hat{\mathbf{j}} + A_z B_z \hat{\mathbf{k}} \cdot \hat{\mathbf{k}} \end{aligned}$$

$$\vec{\mathbf{A}} \cdot \vec{\mathbf{B}} = A_x B_x + A_y B_y + A_z B_z$$

The end result is that the dot product of two vectors is simply the sum of: the product of the two vectors' x components, the product of their y components, and the product of their z components.

Energy Transfer Work vs. Center of Mass Pseudo-Work

I introduced the topic of work by stating that it represents one category of energy transfer to a system. As such, work is energy transfer work. There is a quantity that is calculated in much the same way as work, with one subtle difference. I'm going to call the quantity *center of mass pseudo-work* and I'm going to use a couple of specific processes involving a frictionless horizontal surface, a spring, and a block (and in one case, another block) to distinguish energy transfer work from center of mass pseudo-work. Suppose we attach the spring to the wall so that the spring sticks out horizontally and then push the block toward the wall in such a manner as to compress the spring. Then we release the block from rest and start our observations at the first instant subsequent to release. Let our system be the block. The spring pushes the block away from the wall. The spring transfers energy to the block while the spring is in contact with the block. The work done can be calculated as the integral of vector force dot vector infinitesimal displacement which I'll loosely state as the integral of force times distance. The distance in this case is the displacement (the infinite set of infinitesimal displacements) of the point of application of the force. This kind of work is energy transfer work. It is the amount of energy transferred to the block by the spring.

Now let's disconnect the spring from the wall and attach the spring to the block so that the spring sticks out horizontally from the block and again push the block up against the wall, compressing the spring, and release the block from rest. Let our system be the block plus spring. The block goes sliding off as before, this time with the spring attached. The wall does no energy-transfer work on the system because the part of the wall that is exerting the force on the system is not moving—there is no displacement. However, we find something useful if we calculate the integral of the vector force (exerted by the wall) dot vector infinitesimal displacement of the center of mass of the system—loosely stated, force times distance moved by center of mass. I'm calling that "something useful" the center of mass pseudo-work experienced by the system. It's useful because our Newton's Law derivation shows that quantity to be equal to the change in the center of mass kinetic energy of the system. In this case the system gained some center of mass kinetic energy even though no energy was transferred to it. How did that happen? Energy that was already part of the system, energy stored in the spring, was converted to center of mass kinetic energy.

So what is the subtle difference? In both cases we are, loosely speaking, calculating force times distance. But in the case of energy transfer work, the distance is the distance moved by that element of the agent of the force that is in contact with the victim at exactly that point where the force is being applied, whereas, in the case of center of mass work, the distance in "force times distance" is the distance moved by the center of mass. For a particle, there is no difference. For a truly rigid body undergoing purely translational motion (no rotation) there is no difference. But beware, a truly rigid body is an idealized object in which no bit of the body can move relative to any other bit of the body. Even for such a body, if there is rotation, there will be a difference between the energy transfer work and the center of mass pseudo-work done on the object. Consider for instance a block at rest on a horizontal frictionless surface. You apply an off-center horizontal force to the block for a short distance by pressing on the block with your finger. The work you do is the integrated force times distance over which you move the tip of your finger. It will be greater than the integrated force times the distance over which the center of mass moves. Some of the work you do goes into increasing the center of mass kinetic energy of the rigid body and some of it goes into increasing the rotational kinetic energy of the rigid body. In this case the energy transfer work is greater than the center of mass pseudo-work.

Concluding Remarks

At this point you have two ways of calculating the work done on an object. If you are given information about the force and the path you will use the "force times distance" definition of work. But if you are given information on the effect of the work (the change in kinetic energy) then you will determine the value of the change in kinetic energy and substitute that into the work energy relation, equation 24-2:

$$W = \Delta K$$

to determine the work (or center of mass pseudo-work as applicable). There is yet another method for calculating the work. Like the first method, it is good for cases in which you have information on the force and the path. It only works for certain kinds of forces, but when it does work, to use it, the only thing you need to know about the path is the positions of the endpoints. This third method for calculating the work involves the *potential energy*, the main topic of our next chapter.

25 Potential Energy, Conservation of Energy, Power

The work done on a particle by a force acting on it as that particle moves from point A to point B under the influence of that force, for *some* forces, does not depend on the path followed by the particle. For such a force there is an easy way to calculate the work done on the particle as it moves from point A to point B. One simply has to assign a value of potential energy (of the particle¹) to point A (call that value U_A) and a value of potential energy to point B (call that value U_B). One chooses the values such that the work done by the force in question is just the negative of the difference between the two values.

$$W = -(U_B - U_A)$$

$$W = -\Delta U \quad (25-1)$$

$\Delta U = U_B - U_A$ is the change in the potential energy experienced by the particle as it moves from point A to point B. The minus sign in equation 25-1 ensures that an increase in potential energy corresponds to negative work done by the corresponding force. For instance for the case of near-earth's-surface gravitational potential energy, the associated force is the gravitational force, a.k.a. the gravitational force. If we lift an object upward near the surface of the earth, the gravitational force does negative work on the object since the (downward) force is in the opposite direction to the (upward) displacement. At the same, time, we are increasing the capacity of the particle to do work so we are increasing the potential energy. Thus, we need the “-“ sign in $W = -\Delta U$ to ensure that the change in potential energy method of calculating the work gives the same algebraic sign for the value of the work that the force-along-the path times the length of the path gives.

Note that in order for this method of calculating the work to be useful in any case that might arise, one must assign a value of potential energy to every point in space where the force can act on a particle so that the method can be used to calculate the work done on a particle as the particle moves from any point A to any point B. In general, this means we need a value for each of an infinite set of points in space.

This assignment of a value of potential energy to each of an infinite set of points in space might seem daunting until you realize that it can be done by means of a simple algebraic expression. For instance, we have already written the assignment for a particle of mass m_2 for the case of the universal gravitational force due to a particle of mass m_1 . It was equation 17-5:

$$U = -\frac{G m_1 m_2}{r}$$

¹ The potential energy is actually the potential energy of the system consisting of the particle, whatever the particle is interacting with, and the relevant field. For instance, if we are talking about a particle in the gravitational field of the earth, the potential energy under discussion is the potential energy of the earth plus particle and gravitational field of the earth plus particle. For accounting purposes, it is convenient to ascribe the potential energy to the particle and that is what I do in this book.

in which G is the universal gravitational constant $G = 6.67 \times 10^{-11} \frac{\text{N} \cdot \text{m}^2}{\text{kg}^2}$ and r is the distance that particle 2 is from particle 1. Note that considering particle 1 to be at the origin of a coordinate system, this equation assigns a value of potential energy to every point in the universe! The value, for any point, simply depends on the distance that the point is from the origin. Suppose we want to find the work done by the gravitational force due to particle 1, on particle 2 as particle 2 moves from point A, a distance r_A from particle 1 to point B, a distance r_B from particle 1. The gravitational force exerted on it (particle 2) by the gravitational field of particle 1 does an amount of work, on particle 2, given by (starting with equation 25-1):

$$W = -\Delta U$$

$$W = -(U_B - U_A)$$

$$W = -\left[\left(-\frac{G m_1 m_2}{r_B} \right) - \left(-\frac{G m_1 m_2}{r_A} \right) \right]$$

$$W = G m_1 m_2 \left(\frac{1}{r_B} - \frac{1}{r_A} \right)$$

The Relation Between a Conservative Force and the Corresponding Potential

While this business of calculating the work done on a particle as the negative of the change in its potential energy does make it a lot easier to calculate the work, we do have to be careful to define the potential such that this method is equivalent to calculating the work as the force-along-the-path times the length of the path.

Rather than jump into the problem of finding the potential energy at all points in a three-dimensional region of space for a kind of force known to exist at all points in that three-dimensional region of space, let's look into the simpler problem of finding the potential along a line. We define a coordinate system consisting of a single axis, let's call it the x -axis, with an origin and a positive direction. We put a particle on the line, a particle that can move along the line. We assume that we have a force that acts on the particle wherever the particle is on the line and that the force is directed along the line. While we will also address the case of a force which has the same value at different points along the line, we assume that, in general, *the force varies with position*. ← Remember this fact so that you can find the flaw discussed below. Because we want to define a potential for it, it is important that the work done on the particle by the force being exerted on the particle, as the particle moves from point A to point B does not depend on how the particle gets from point A to point B. Our goal is to define a potential energy function for the force such that we get the same value for the work done on the particle by the force whether we use the force-along-the-path method to calculate it or the negative of the change of

potential energy method. Suppose the particle undergoes a displacement Δx along the line under the influence of the force. See if you can see the flaw in the following, before I point it out: We write $W = F \Delta x$ for the work done by the force, calculated using the force-along-the-path times the length of the path idea, and then $W = -\Delta U$ for the work done by the force calculated using the negative of the change in potential energy concept. Setting the two expressions equal to each other, we have, $F \Delta x = -\Delta U$ which we can write as $F = -\frac{\Delta U}{\Delta x}$ for the relation between the potential energy and the x -component of the force.

Do you see where we went wrong? While the method will work for the special case in which the force is a constant, we were supposed to come up with a relation that was good for the general case in which the force varies with position. That means that for each value of x in the range of values extending from the initial value, let's call it x_A , to the value at the end of the displacement $x_A + \Delta x$, there is a different value of force. So the expression $W = F \Delta x$ is inappropriate. Given a numerical problem, there is no one value to plug in for F , because F varies along the Δx .

To fix things, we can shrink Δx to infinitesimal size, so small that, x_A and $x_A + \Delta x$ are, for all practical purposes, one and the same point. That is to say, we take the limit as $\Delta x \rightarrow 0$. Then our relation becomes

$$F_x = \lim_{\Delta x \rightarrow 0} \left(-\frac{\Delta U}{\Delta x} \right)$$

which is the same thing as

$$F_x = -\lim_{\Delta x \rightarrow 0} \left(\frac{\Delta U}{\Delta x} \right)$$

The limit of $\frac{\Delta U}{\Delta x}$ that appears on the right is none other than the derivative $\frac{dU}{dx}$, so:

$$F_x = -\frac{dU}{dx} \quad (25-2)$$

To emphasize the fact that force is a vector, we write it in unit vector notation as:

$$\vec{\mathbf{F}} = -\frac{dU}{dx} \hat{\mathbf{i}} \quad (25-3)$$

Let's make this more concrete by using it to determine the potential energy due to a force with which you are familiar—the force due to a spring.

Consider a block on frictionless horizontal surface. The block is attached to one end of a spring. The other end of the spring is attached to a wall. The spring extends horizontally away from the wall, at right angles to the wall. Define an x -axis with the origin at the equilibrium position of that end of the spring which is attached to the block. Consider the away-from-the-wall direction to be the positive x direction. Experimentally, we find that the force exerted by the spring on the block is given by:

$$\vec{F} = -kx\hat{x} \quad (25-4)$$

where k is the force constant of the spring. (Note: A positive x , corresponding to the block having been pulled away from the wall, thus stretching the spring, results in a force in the negative x direction. A negative x , compressed spring, results in a force in the $+x$ direction, consistent with common sense.) By comparison with equation 25-3 (the one that reads $\vec{F} = -\frac{dU}{dx}\hat{x}$) we note that the potential energy function has to be defined so that

$$\frac{dU}{dx} = kx$$

This is such a simple case that we can pretty much guess what U has to be. U has to be defined such that when we take the derivative of it we get a constant (the k) times x to the power of 1. Now when you take the derivative of x to a power, you reduce the power by one. For that to result in a power of 1, the original power must be 2. Also, the derivative of a constant times something yields that same constant times the derivative, so, there must be a factor of k in the potential energy function. Let's try $U = kx^2$ and see where that gets us. The derivative of kx^2 is $2kx$. Except for that factor of 2 out front, that is exactly what we want. Let's amend our guess

by multiplying it by a factor of $\frac{1}{2}$, to eventually cancel out the 2 that comes down when we take the derivative. With $U = \frac{1}{2}kx^2$ we get $\frac{dU}{dx} = kx$ which is exactly what we needed. Thus

$$U = \frac{1}{2}kx^2 \quad (25-5)$$

is indeed the potential energy for the force due to a spring. You used this expression back in chapter 2. Now you know where it comes from.

We have considered two other conservative forces. For each, let's find the potential energy function U that meets the criterion that we have written as, $\vec{F} = -\frac{dU}{dx}\hat{x}$.

First, let's consider the near-earth's-surface gravitational force exerted on an object of mass m , by the earth. We choose our single axis to be directed vertically upward with the origin at an arbitrary but clearly specified and fixed *elevation* for the entire problem that one might solve using the concepts under consideration here. By convention, we call such an axis the y axis rather than the x axis. Now we know that the gravitational force is given simply (again, this is an experimental result) by

$$\vec{F} = -mg\hat{j}$$

where the mg is the known magnitude of the gravitational force and the $-\hat{j}$ is the downward direction.

Equation 25-3, written for the case at hand is:

$$\vec{F} = -\frac{dU}{dy}\hat{j}$$

For the last two equations to be consistent with each other, we need U to be defined such that

$$\frac{dU}{dy} = mg$$

For the derivative of U with respect to y to be the constant " mg ", U must be given by

$$U = mgy \quad (25-6)$$

and indeed this is the equation for the earth's near-surface gravitational potential energy. Please verify that when you take the derivative of it with respect to y , you do indeed get the magnitude of the gravitational force, mg .

Now let's turn our attention to the Universal Law of Gravitation. Particle number 1 of mass m_1 creates a gravitational field in the region of space around it. Let's define the position of particle number 1 to be the origin of a three-dimensional Cartesian coordinate system. Now let's assume that particle number 2 is at some position in space, a distance r away from particle 1. Let's define the direction that particle 2 is in, relative to particle 1, as the $+x$ direction. Then, the coordinates of particle 2 are $(r, 0, 0)$. r is then the x component of the position vector for particle 2, a quantity that we shall now call x . That is, x is defined such that $x=r$. In terms of the coordinate system thus defined, the force exerted by the gravitational field of particle 1, on particle 2, is given by:

$$\vec{F} = -\frac{Gm_1m_2}{x^2}\hat{i}$$

which I rewrite here:

$$\vec{F} = -\frac{Gm_1m_2}{x^2}\hat{x}$$

Compare this with equation 25-3:

$$\vec{F} = -\frac{dU}{dx}\hat{x}$$

Combining the two equations, we note that our expression for the potential energy U in terms of x must satisfy the equation

$$\frac{dU}{dx} = \frac{Gm_1m_2}{x^2}$$

It's easier to deduce what U must be if we write this as

$$\frac{dU}{dx} = Gm_1m_2x^{-2}$$

For the derivative of U with respect to x to be a constant (Gm_1m_2) times a power (-2) of x , U itself must be that same constant (Gm_1m_2) times x to the next higher power (-1), divided by the value of the latter power.

$$U = \frac{Gm_1m_2x^{-1}}{-1}$$

which can be written

$$U = -\frac{Gm_1m_2}{x}$$

Recalling that the x in the denominator is simply the distance from particle 1 to particle 2 which we have also defined to be r , we can write this in the form in which it is more commonly written:

$$U = -\frac{Gm_1m_2}{r} \quad (25-7)$$

This is indeed the expression for the gravitational potential that we gave you (without any justification for it) back in Chapter 17, the chapter on the Universal Law of Gravitation.

Conservation of Energy Revisited

Recall the work-energy relation, equation 24-2 from last chapter,

$$W = \Delta K ,$$

the statement that work causes a change in kinetic energy. Now consider a case in which all the work is done by conservative forces, so, the work can be expressed as the negative of the change in potential energy.

$$-\Delta U = \Delta K$$

Further suppose that we are dealing with a situation in which a particle moves from point A to point B under the influence of the force or forces corresponding to the potential energy U .

Then, the preceding expression can be written as:

$$-(U_B - U_A) = K_B - K_A$$

$$-U_B + U_A = K_B - K_A$$

$$K_A + U_A = K_B + U_B$$

Switching over to notation in which we use primed variables to characterize the particle when it is at point B and unprimed variables at A we have:

$$K + U = K' + U'$$

Interpreting $E = K + U$ as the energy of the system at the “before” instant, and $E' = K' + U'$ as the energy of the system at the “after” instant, we see that we have derived the conservation of mechanical energy statement for the special case of no net energy transfer to or from the surroundings and no conversion of energy within the system from mechanical energy to other forms or vice versa. In equation form, the statement is

$$E = E' \tag{25-8}$$

an equation to which you were introduced in chapter 2. Note that you would be well advised to review chapter 2 now, because for the current chapter, you are again responsible for solving any of the “chapter-2-type” problems (remembering to include, and correctly use, before and after diagrams) and answer any of the “chapter-2-type” questions.

Power

In this last section on energy we address a new topic. As a separate and important concept, it would deserve its own chapter except for the fact that it is such a simple, straightforward concept. *Power* is the rate of energy transfer, energy conversion, and in some cases, the rate at which transfer and conversion of energy are occurring simultaneously. When you do work on an object, you are transferring energy to that object. Suppose for instance that you are pushing a block across a horizontal frictionless surface. You are doing work on the object. The kinetic energy of the object is increasing. The rate at which the kinetic energy is increasing is referred to as power. The rate of change of any quantity (how fast that quantity is changing) can be calculated as the derivative of that quantity with respect to time. In the case at hand, the power P can be expressed as

$$P = \frac{dK}{dt} \quad (25-9)$$

the time derivative of the kinetic energy. Since $K = \frac{1}{2}mv^2$ we have

$$P = \frac{d}{dt} \frac{1}{2}mv^2$$

$$P = \frac{1}{2}m \frac{d}{dt}v^2$$

$$P = \frac{1}{2}m2v \frac{dv}{dt}$$

$$P = m \frac{dv}{dt}v$$

$$P = ma_{\parallel}v$$

$$P = F_{\parallel}v$$

$$P = \vec{\mathbf{F}} \cdot \vec{\mathbf{v}} \quad (25-10)$$

where a_{\parallel} is the acceleration component parallel to the velocity vector. The perpendicular component changes the direction of the velocity but not the magnitude.

Besides the rate at which the kinetic energy is changing, the power is the rate at which work is being done on the object. In an infinitesimal time interval dt , you do an infinitesimal amount of work

$$dW = \vec{\mathbf{F}} \cdot d\vec{\mathbf{x}}$$

on the object. Dividing both sides by dt , we have

$$\frac{dW}{dt} = \vec{\mathbf{F}} \cdot \frac{d\vec{\mathbf{x}}}{dt}$$

which again is

$$P = \vec{\mathbf{F}} \cdot \vec{\mathbf{v}}$$

as it must be since, in accord with the work-energy relation, the rate at which you do work on the object has to be the rate at which the kinetic energy of the object increases.

If you do work at a steady rate for a finite time interval, the power is constant and can simply be calculated as the amount of work done during the time interval divided by the time interval itself. For instance, when you climb stairs, you convert chemical energy stored in your body to gravitational potential energy. The rate at which you do this is power. If you climb at a steady rate for a total increase of gravitational potential energy of ΔU over a time interval Δt then the constant value of your power during that time interval is

$$P = \frac{\Delta U}{\Delta t} \quad (25-11)$$

If you know that the power is constant, you know the value of the power P , and you are asked to find the total amount of work done, the total amount of energy transferred, and/or the total amount of energy converted during a particular time interval Δt , you just have to multiply the power P by the time interval Δt .

$$\text{Energy} = P \Delta t \quad (25-12)$$

One could include at least a dozen formulas on your formula sheet for power, but they are all so simple that, if you understand what power is, you can come up with the specific formula you need for the case on which you are working. We include but one formula on the formula sheet,

$$P = \frac{dE}{dt} \quad (25-13)$$

which should remind you what power is. Since power is the rate of change of energy, the SI units of power must be $\frac{\text{J}}{\text{s}}$. This combination unit is given a name, the watt, abbreviated W.

$$1 \text{ W} \equiv 1 \frac{\text{J}}{\text{s}}$$

26 Impulse and Momentum

First, a Few More Words on Work and Energy, for Comparison Purposes

Imagine a gigantic air hockey table with a whole bunch of pucks of various masses, none of which experiences any friction with the horizontal surface of the table. Assume air resistance to be negligible. Now suppose that you come up and give each puck a shove, where the kind of shove that you give the first one is special in that the whole time you are pushing on that puck, the force has one and the same value; and the shove that you give each of the other pucks is similar in the following respect: To each puck you apply the same force that you applied to the first puck, over the same exact distance. Since you give each of the pucks a similar shove, you might expect the motion of the pucks (after the shove) to have something in common and indeed we find that, while the pucks (each of which, after the shove, moves at its own constant velocity) have speeds that differ from one another (because they have different masses), they all have the same value of the product mv^2 and indeed if you put a $\frac{1}{2}$ in front of that product and call it

kinetic energy K , the common value of $\frac{1}{2}mv^2$ is identical to the product of the magnitude of the force used during the shove, and the distance over which the force is applied. This latter product is what we have defined to be the work W and we recognize that we are dealing with a special case of the work energy principle $W = \Delta K$, a case in which, for each of the pucks, the initial kinetic energy is zero. We can modify our experiment to obtain more general results, e.g. a smaller constant force over a greater distance results in the same kinetic energy as long as the product of the magnitude of the force and the distance over which it is applied is the same as it was for the other pucks, but it is interesting to consider how different it would seem to us, in the original experiment, as we move from a high-mass puck to a low mass puck. Imagine doing that. You push on the high-mass puck with a certain force, for a certain distance. Now you move on to a low-mass puck. As you push on it from behind, with the same force that you used on the high-mass puck, you notice that the low-mass puck speeds up much more rapidly. You probably find it much more difficult to maintain a steady force because it is simply more difficult to “keep up” with the low mass puck. And of course, it covers the specified distance in a much shorter amount of time. So, although you push it for the same distance, you must push the low-mass puck for a shorter amount of time in order to make it so that both pucks have one and the same kinetic energy. Pondering on it you recognize that if you were to push the low-mass puck for the same amount of *time* as you did the high-mass puck (with the same force), that the low-mass puck would have a greater kinetic energy after the shove, because you would have to push on it over a greater distance, meaning you would have done more work on it. Still, you imagine that if you were to push on each of the pucks for the same amount of time (rather than distance), that their respective motions would have to have something in common, because again, there is something similar about their respective shoves.

Now we Move on to Impulse and Momentum

You decide to do the experiment you have been thinking about. You place each of the pucks at rest on the frictionless surface. You apply one and the same constant force to each of the pucks for one and the same amount of time. Once again, you find this more difficult with the lower mass pucks. While you are pushing on it, a low-mass puck speeds up faster than a high-mass puck does. As a result you have to keep pushing on a low-mass puck over a greater distance and

it is going faster when you let it go. Having given all the pucks a similar shove, you expect there to be something about the motion of each of the pucks that is the same as the corresponding characteristic of the motion of all the other pucks. We have already established that the smaller the mass of the puck, the greater the speed, and the greater the kinetic energy of the puck. Experimentally, we find that all the pucks have one and the same value of the product $m\bar{v}$, where \bar{v} is the post-shove puck velocity. Further, we find that the value of $m\bar{v}$ is equal to the product of the constant force \bar{F} and the time interval Δt for which it was applied.

That is,

$$\bar{F}\Delta t = m\bar{v}$$

The product of the force and the time interval for which it is applied is such an important quantity that we give it a name, *impulse*, and a symbol \bar{J} .

$$\bar{J} = \bar{F}\Delta t \quad (26-1)$$

Also, as you probably recall from chapter 4, by definition, the product of the mass of an object, and its velocity, is the momentum \bar{p} of the object.

Thus, the results of the experiment described above can be expressed as

$$\bar{J} = \bar{p}$$

The experiment dealt with a special case, the case in which each object was initially at rest. If we do a similar experiment in which, rather than being initially at rest, each object has some known initial velocity, we find, experimentally, that the impulse is actually equal to the change in momentum.

$$\bar{J} = \Delta\bar{p} \quad (26-2)$$

Of course if we start with zero momentum, then the change in momentum *is* the final momentum.

Equation 26-2, $\bar{J} = \Delta\bar{p}$, is referred to as the *Impulse-Momentum Relation*. It is a cause and effect relationship. You apply some impulse (force times time) to an object, and the effect is a change in the momentum of the object. The result, which we have presented as an experimental result, can be derived from Newton's second law of motion. Here we do so for the case in which the force acting on the object is constant during the time interval under consideration. Note that the force which appears in the definition of impulse is the net external force acting on the object. Consider the case of a particle, of mass m , which has but one, constant force (which could actually be the vector sum of all the forces) acting on it.

As always, in applying Newton's second law of motion, we start by drawing a free body diagram:

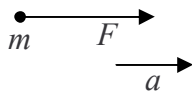

In order to keep track of the vector nature of the quantities involved we apply Newton's 2nd Law in vector form (equation 14-1):

$$\vec{a} = \frac{1}{m} \sum \vec{F}$$

In the case at hand the sum of the forces is just the one force \vec{F} , so:

$$\vec{a} = \frac{1}{m} \vec{F}$$

Solving for F , we arrive at:

$$\vec{F} = m\vec{a}$$

multiplying both sides by Δt we obtain

$$\vec{F}\Delta t = m\vec{a}\Delta t$$

Given that the force is constant, the resulting acceleration is constant. In the case of a constant acceleration, the acceleration can be written as the ratio of the change in v that occurs during the time interval Δt , to the time interval Δt itself.

$$\vec{a} = \frac{\vec{\Delta v}}{\Delta t}$$

Substituting this into the preceding expression yields:

$$\vec{F}\Delta t = m \frac{\vec{\Delta v}}{\Delta t} \Delta t$$

$$\vec{F}\Delta t = m\vec{\Delta v}$$

The change in velocity can be expressed as the final velocity \vec{v}' (the velocity at the end of the time interval during which the force acts) minus the initial velocity \vec{v} (the velocity at the start of the time interval): $\vec{\Delta v} = \vec{v}' - \vec{v}$. Substituting this into $\vec{F}\Delta t = m\vec{\Delta v}$ yields

$$\vec{F}\Delta t = m(\vec{v}' - \vec{v})$$

which can be written as

$$\vec{F}\Delta t = m\vec{v}' - m\vec{v}$$

Recognizing that $m\vec{v}'$ is the final momentum and that $m\vec{v}$ is the initial momentum we realize that we have

$$\vec{F}\Delta t = \vec{p}' - \vec{p}$$

On the left, we have what is defined to be the impulse, and on the right we have the change in momentum (equation 26-2):

$$\vec{J} = \Delta\vec{p}$$

This completes our derivation of the impulse momentum relation from Newton's 2nd Law.

Conservation of Momentum Revisited

Regarding the conservation of momentum, we first note that, for a particle, if the net external force on the particle is zero, then the impulse, defined by $\vec{J} = \vec{F}\Delta t$, delivered to that particle during any time interval Δt , is 0. If the impulse is zero then from $\vec{J} = \Delta\vec{p}$, the change in momentum must be 0. This means that the momentum \vec{p} is a constant, and since $\vec{p} = m\vec{v}$, if the momentum is constant, the velocity must be constant. This result simply confirms that, in the absence of a force, our impulse momentum relation is consistent with Newton's 1st Law of Motion, the one that states that if there is no force on a particle, then the velocity of that particle does not change.

Now consider the case of two particles in which no external forces are exerted on either of the particles. (For a system of two particles, an internal force would be a force exerted by one particle on the other. An external force is a force exerted by something outside the system on something inside the system.) The total momentum of the pair of particles is the vector sum of the momentum of one of the particles and the momentum of the other particle. Suppose that the particles are indeed exerting forces on each other during a time interval Δt . To keep things simple we will assume that the force that either exerts on the other is constant during the time interval. Let's identify the two particles as particle #1 and particle #2 and designate the force exerted by 1 on 2 as \vec{F}_{12} . Because this force is exerted on particle #2, it will affect the motion of particle #2 and we can write the impulse momentum relation as

$$\vec{F}_{12}\Delta t = \Delta\vec{p}_2 \quad (26-3)$$

Now particle #1 can't exert a force on particle 2 without particle #2 exerting an equal and opposite force back on particle 1. That is, the force \vec{F}_{21} exerted by particle #2 on particle #1 is the negative of \vec{F}_{12} .

$$\vec{F}_{21} = -\vec{F}_{12}$$

Of course \vec{F}_{21} ("eff of 2 on 1") affects the motion of particle 1 only, and the impulse-momentum relation for particle 1 reads

$$\vec{F}_{21}\Delta t = \Delta\vec{p}_1$$

Replacing \vec{F}_{21} with $-\vec{F}_{12}$ we obtain

$$-\vec{F}_{12}\Delta t = \Delta\vec{p}_1 \quad (26-4)$$

Now add equation 26-3 ($\vec{F}_{12}\Delta t = \Delta\vec{p}_2$) and equation 26-4 together. The result is:

$$\begin{aligned} \vec{F}_{12}\Delta t - \vec{F}_{12}\Delta t &= \Delta\vec{p}_1 + \Delta\vec{p}_2 \\ 0 &= \Delta\vec{p}_1 + \Delta\vec{p}_2 \end{aligned}$$

On the right is the total change in momentum for the pair of particles $\Delta\vec{p}_{\text{TOTAL}} = \Delta\vec{p}_1 + \Delta\vec{p}_2$ so what we have found is that

$$0 = \Delta\vec{p}_{\text{TOTAL}}$$

which can be written as

$$\Delta\vec{p}_{\text{TOTAL}} = 0 \quad (26-5)$$

Recapping: If the net external force acting on a pair of particles is zero, the total momentum of the pair of particles does not change. Add a third particle to the mix and any momentum change that it might experience because of forces exerted on it by the original two particles would be canceled by the momentum changes experienced by the other two particles as a result of the interaction forces exerted on them by the third particle. We can extend this to any number of particles, and since objects are made of particles, the concept applies to objects. That is, if, during some time interval, the net external force exerted on a system of objects is zero, then the momentum of that system of objects will not change.

As you should recall from Chapter 4, the concept is referred to as conservation of momentum for the special case in which there is no net transfer of momentum to the system from the surroundings, and you apply it in the case of some physical process such as a collision, by picking a before instant and an after instant, drawing a sketch of the situation at each instant, and writing the fact that, the momentum in the before picture has to be equal to the momentum in the after picture, in equation form: $\vec{p} = \vec{p}'$. When you read this chapter, you should again consider yourself responsible for solving any of the problems, and answering any of the questions, that you were responsible for back in Chapter 4.

27 Oscillations: Introduction, Mass on a Spring

If a simple harmonic oscillation problem does not involve the time, you should probably be using conservation of energy to solve it. A common “tactical error” in problems involving oscillations is to manipulate the equations giving the position and velocity as a function of time, $x = x_{\max} \cos(2\pi f t)$ and

$v = -v_{\max} \sin(2\pi f t)$ rather than applying the principle of conservation of energy.

This turns an easy five-minute problem into a difficult fifteen-minute problem.

When something goes back and forth we say it vibrates or oscillates. In many cases oscillations involve an object whose position as a function of time is well characterized by the sine or cosine function of the product of a constant and elapsed time. Such motion is referred to as sinusoidal oscillation. It is also referred to as simple harmonic motion.

Math Aside: The Cosine Function

By now, you have had a great deal of experience with the cosine function of an angle as the ratio of the adjacent to the hypotenuse of a right triangle. This definition covers angles from 0 radians to $\frac{\pi}{2}$ radians (0° to 90°). In applying the cosine function to simple harmonic motion, we use the

extended definition which covers all angles. The extended definition of the cosine of the angle θ is that the cosine of an angle is the x component of a unit vector, the tail of which is on the origin of an x - y coordinate system; a unit vector that originally pointed in the $+x$ direction but has since been rotated counterclockwise from our viewpoint, through the angle θ , about the origin.

Here we show that the extended definition is consistent with the “adjacent over hypotenuse” definition, for angles between 0 radians and $\frac{\pi}{2}$ radians.

For such angles, we have:

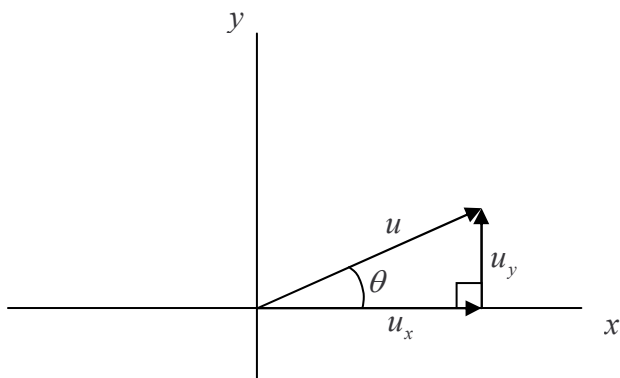

in which, u , being the magnitude of a unit vector, is of course equal to 1, the pure number 1 with no units. Now, according to the ordinary definition of the cosine of θ as the adjacent over the hypotenuse:

$$\cos \theta = \frac{u_x}{u}$$

Solving this for u_x we see that

$$u_x = u \cos \theta$$

Recalling that $u = 1$, this means that

$$u_x = \cos \theta$$

Recalling that our extended definition of $\cos \theta$ is, that it is the x component of the unit vector $\hat{\mathbf{u}}$ when $\hat{\mathbf{u}}$ makes an angle θ with the x -axis, this last equation is just saying that, for the case at hand (θ between 0 and $\frac{\pi}{2}$ radians) our extended definition of $\cos \theta$ is equivalent to our ordinary definition.

At angles between $\frac{\pi}{2}$ and $\frac{3\pi}{2}$ radians (90° and 270°) we see that u_x takes on negative values (when the x component *vector* is pointing in the negative x direction, the x component *value* is, by definition, negative). According to our extended definition, $\cos \theta$ takes on negative values at such angles as well.

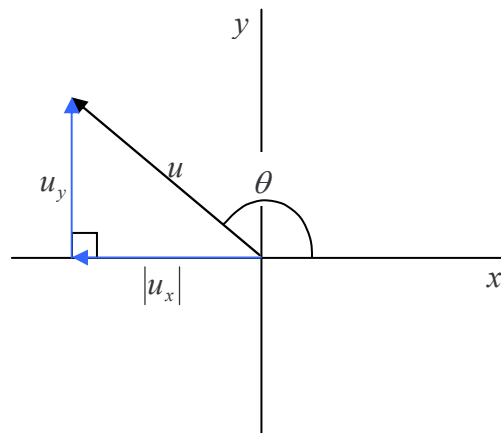

With our extended definition, valid for any angle θ , a graph of the $\cos \theta$ vs. θ appears as:

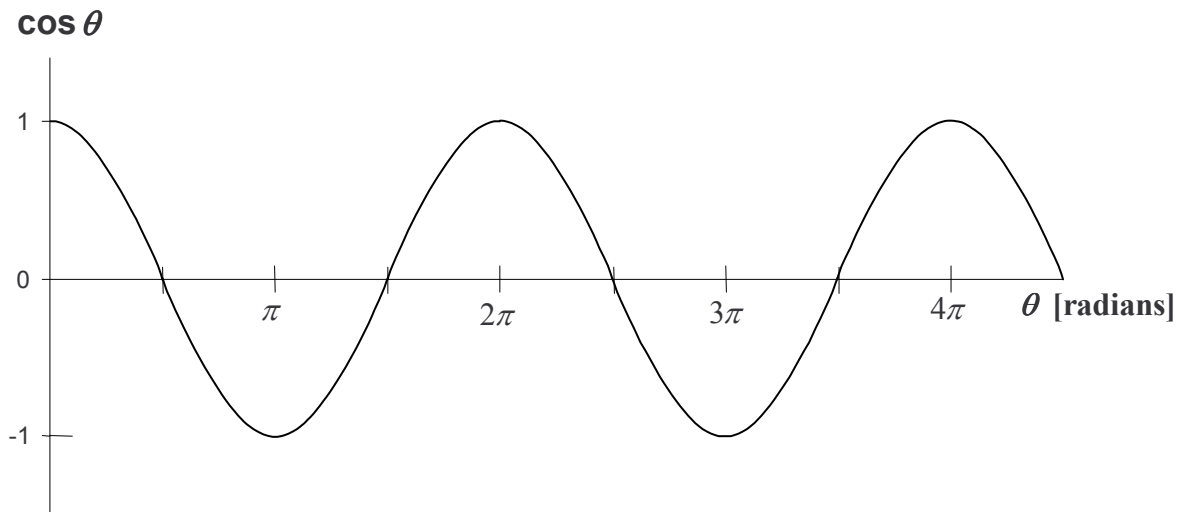

Some Calculus Relations Involving the Cosine

The derivative of the cosine of θ , with respect to θ :

$$\frac{d}{d\theta} \cos \theta = -\sin \theta$$

The derivative of the sine of θ , with respect to θ :

$$\frac{d}{d\theta} \sin \theta = \cos \theta$$

Some Jargon Involving The Sine And Cosine Functions

When you express, define, or evaluate the function of something, that something is called the argument of the function. For instance, suppose the function is the square root function and the expression in question is $\sqrt{3x}$. The expression is the square root of $3x$, so, in that expression, $3x$ is the argument of the square root function. Now when you take the cosine of something, that something is called the argument of the cosine, but in the case of the sine and cosine functions, we give it another name as well, namely, the phase. So, when you write $\cos \theta$, the variable θ is the argument of the cosine function, but it is also referred to as the *phase* of the cosine function.

In order for an expression involving the cosine function to be at all meaningful, the phase of the cosine must have units of angle (for instance, radians or degrees).

A Block Attached to the End of a Spring

Consider a block of mass m on a frictionless horizontal surface. The block is attached, by means of an ideal massless horizontal spring having force constant k , to a wall. A person has pulled the block out, directly away from the wall, and released it from rest. The block oscillates back and forth (toward and away from the wall), on the end of the spring. We would like to find equations that give the block's position, velocity, and acceleration as functions of time. We start by applying Newton's 2nd Law to the block. Before drawing the free body diagram we draw a sketch to help identify our one-dimensional coordinate system. We will call the horizontal position of the point at which the spring is attached, the position x of the block. The origin of our coordinate system will be the position at which the spring is neither stretched nor compressed. When the position x is positive, the spring is stretched and exerts a force, on the block, in the $-x$ direction. When the position of x is negative, the spring is compressed and exerts a force, on the block, in the $+x$ direction.

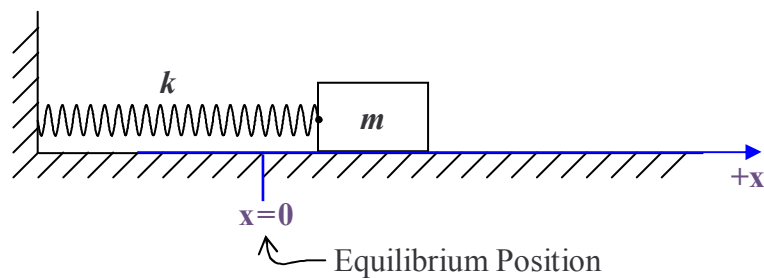

Now we draw the free body diagram of the block:

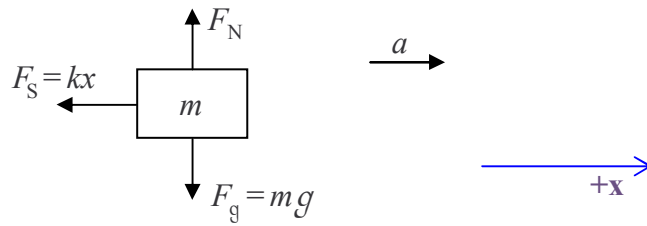

and apply Newton's 2nd Law:

$$a_{\rightarrow} = \frac{1}{m} \sum F_{\rightarrow}$$

$$a = \frac{1}{m} (-kx)$$

$$a = -\frac{k}{m} x$$

This equation, relating the acceleration of the block to its position x , can be considered to be an equation relating the position of the block to time if we substitute for a using:

$$a = \frac{dv}{dt}$$

and

$$v = \frac{dx}{dt}$$

so

$$a = \frac{d}{dt} \frac{dx}{dt}$$

which is usually written

$$a = \frac{d^2x}{dt^2} \quad (27-1)$$

and read "d squared x by dt squared" or "the second derivative of x with respect to t ."

Substituting this expression for a into $a = -\frac{k}{m} x$ (the result we derived from Newton's 2nd Law above) yields

$$\frac{d^2x}{dt^2} = -\frac{k}{m}x \quad (27-2)$$

We know in advance that the position of the block depends on time. That is to say, x is a function of time. This equation, equation 27-2, tells us that if you take the second derivative of x with respect to time you get x itself, times a negative constant ($-k/m$).

We can find the an expression for x in terms of t that solves 27-2 by the method of “guess and check.” Grossly, we’re looking for a function whose second derivative is essentially the negative of itself. Two functions meet this criterion, the sine and the cosine. Either will work. We arbitrarily choose to use the cosine function. We include some constants in our trial solution (our guess) to be determined during the “check” part of our procedure. Here’s our trial solution:

$$x = x_{\max} \cos\left(\frac{2\pi \text{ rad}}{T} t\right)$$

Here’s how we have arrived at this trial solution: Having established that x , depends on the cosine of a multiple of the time variable, we let the units be our guide. We need the time t to be part of the argument of the cosine, but we can’t take the cosine of something unless that something has units of angle. The constant $\frac{2\pi \text{ rad}}{T}$, with the constant T having units of time (we’ll use seconds), makes it so that the argument of the cosine has units of radians. It is, however, more than just the units that motivates us to choose the ratio $\frac{2\pi \text{ rad}}{T}$ as the constant.

To make the argument of the cosine have units of radians, all we need is a constant with units of radians per second. So why write it as $\frac{2\pi \text{ rad}}{T}$? Here’s the explanation: The block goes back and forth. That is, it repeats its motion over and over again as time goes by. Starting with the block at its maximum distance from the wall, the block moves toward the wall, reaches its closest point of approach to the wall and then comes back out to its maximum distance from the wall. At that point, it’s right back where it started from. We define the constant value of time T to be the amount of time that it takes for one iteration of the motion.

Now consider the cosine function. We chose it because its second derivative is the negative of itself, but it is looking better and better as a function that gives the position of the block as a function of time because it too repeats itself as its phase (the argument of the cosine) continually increases. Suppose the phase starts out as 0 at time 0. The cosine of 0 radians is 1, the biggest the cosine ever gets. We can make this correspond to the block being at its maximum distance from the wall. As the phase increases, the cosine gets smaller, then goes negative, eventually reaching the value -1 when the phase is π radians. This could correspond to the block being closest to the wall. Then, as the phase continues to increase, the cosine increases until, when the phase is 2π , the cosine is back up to 1 corresponding to the block being right back where it started from. From here, as the phase of the cosine continues to increase from 2π to 4π , the

cosine again takes on all the values that it took on from 0 to 2π . The same thing happens again as the phase increases from 4π to 6π , from 8π to 10π , etc.

Getting back to that constant $\frac{2\pi \text{ rad}}{T}$ that we “guessed” should be in the phase of the cosine in our trial solution for $x(t)$:

$$x = x_{\max} \cos\left(\frac{2\pi \text{ rad}}{T} t\right)$$

With T being defined as the time it takes for the block to go back and forth once, look what happens to the phase of the cosine as the stopwatch reading continually increases. Starting from 0, as t increases from 0 to T , the phase of the cosine, $\frac{2\pi \text{ rad}}{T} t$, increases from 0 to 2π radians.

So, just as the block, from time 0 to time T , goes through one cycle of its motion, the cosine, from time 0 to time T , goes through one cycle of its pattern. As the stopwatch reading increases from T to $2T$, the phase of the cosine increases from 2π rad to 4π rad. The block undergoes the second cycle of its motion and the cosine function used to determine the position of the block goes through the second cycle of its pattern. The idea holds true for any time t —as the stopwatch reading continues to increase, the cosine function keeps repeating its cycle in exact synchronization with the block, as it must if its value is to accurately represent the position of the block as a function of time. Again, it is no coincidence. We chose the constant $\frac{2\pi \text{ rad}}{T}$ in the phase of the cosine so that things would work out this way.

A few words on jargon are in order before we move on. The time T that it takes for the block to complete one full cycle of its motion is referred to as the *period* of the oscillations of the block.

Now how about that other constant, the “ x_{\max} ” in our educated guess $x = x_{\max} \cos\left(\frac{2\pi \text{ rad}}{T} t\right)$?

Again, the units were our guide. When you take the cosine of an angle, you get a pure number, a value with no units. So, we need the x_{\max} there to give our function units of distance (we’ll use meters). We can further relate x_{\max} to the motion of the block. The biggest the cosine of the phase can ever get is 1, thus, the biggest x_{\max} times the cosine of the phase can ever get is x_{\max} .

So, in the expression $x = x_{\max} \cos\left(\frac{2\pi \text{ rad}}{T} t\right)$, with x being the position of the block at any time t , x_{\max} must be the maximum position of the block, the position of the block, relative to its equilibrium position, when it is as far from the wall as it ever gets.

Okay, we’ve given a lot of reasons why $x = x_{\max} \cos\left(\frac{2\pi \text{ rad}}{T} t\right)$ should well describe the motion of the block, but unless it is consistent with Newton’s 2nd Law, that is, unless it satisfies equation 27-2:

$$\frac{d^2x}{dt^2} = -\frac{k}{m}x$$

which we derived from Newton's 2nd Law, it is no good. So, let's plug it into equation 27-2 and see if it works. First, let's take the second derivative $\frac{d^2x}{dt^2}$ of our trial solution with respect to t (so we can plug it and x itself directly into equation 27-2):

Given

$$x = x_{\max} \cos\left(\frac{2\pi \text{ rad}}{T}t\right),$$

the first derivative is

$$\frac{dx}{dt} = x_{\max} \left[-\sin\left(\frac{2\pi \text{ rad}}{T}t\right) \right] \frac{2\pi \text{ rad}}{T}$$

$$\frac{dx}{dt} = -\frac{2\pi \text{ rad}}{T} x_{\max} \sin\left(\frac{2\pi \text{ rad}}{T}t\right)$$

The second derivative is then

$$\frac{d^2x}{dt^2} = -\frac{2\pi \text{ rad}}{T} x_{\max} \cos\left(\frac{2\pi \text{ rad}}{T}t\right) \frac{2\pi \text{ rad}}{T}$$

$$\frac{d^2x}{dt^2} = -\left(\frac{2\pi \text{ rad}}{T}\right)^2 x_{\max} \cos\left(\frac{2\pi \text{ rad}}{T}t\right)$$

Now we are ready to substitute this and x itself, $x = x_{\max} \cos\left(\frac{2\pi \text{ rad}}{T}t\right)$, into the differential

equation $\frac{d^2x}{dt^2} = -\frac{k}{m}x$ (equation 27-2) stemming from Newton's 2nd Law of Motion. The substitution yields:

$$-\left(\frac{2\pi \text{ rad}}{T}\right)^2 x_{\max} \cos\left(\frac{2\pi \text{ rad}}{T}t\right) = -\frac{k}{m} x_{\max} \cos\left(\frac{2\pi \text{ rad}}{T}t\right)$$

which we copy here for your convenience.

$$-\left(\frac{2\pi \text{ rad}}{T}\right)^2 x_{\max} \cos\left(\frac{2\pi \text{ rad}}{T}t\right) = -\frac{k}{m}x_{\max} \cos\left(\frac{2\pi \text{ rad}}{T}t\right)$$

The two sides are the same, by inspection, except that where $\left(\frac{2\pi \text{ rad}}{T}\right)^2$ appears on the left, we have $\frac{k}{m}$ on the right. Thus, substituting our guess, $x = x_{\max} \cos\left(\frac{2\pi \text{ rad}}{T}t\right)$, into the differential equation that we are trying to solve, $\frac{d^2x}{dt^2} = -\frac{k}{m}x$ (equation 27-2) leads to an identity if and only

if $\left(\frac{2\pi \text{ rad}}{T}\right)^2 = \frac{k}{m}$. This means that the period T is determined by the characteristics of the spring and the block, more specifically by the force constant (the “stiffness factor”) k of the spring, and the mass (the inertia) of the block. Let’s solve for T in terms of these quantities.

From $\left(\frac{2\pi \text{ rad}}{T}\right)^2 = \frac{k}{m}$ we find:

$$\frac{2\pi \text{ rad}}{T} = \sqrt{\frac{k}{m}}$$

$$T = 2\pi \text{ rad} \sqrt{\frac{m}{k}}$$

$$T = 2\pi \sqrt{\frac{m}{k}} \quad (27-3)$$

where we have taken advantage of the fact that a radian is, by definition, 1 m/m by simply deleting the “rad” from our result.

The presence of the m in the numerator means that the greater the mass, the longer the period. That makes sense: we would expect the block to be more “sluggish” when it has more mass. On the other hand, the presence of the k in the *denominator* means that the stiffer the spring, the shorter the period. This makes sense too in that we would expect a stiff spring to result in quicker oscillations. Note the absence of x_{\max} in the result for the period T . Many folks would expect that the bigger the oscillations, the longer it would take the block to complete each oscillation, but the absence of x_{\max} in our result for T shows that it just isn’t so. The period T does not depend on the size of the oscillations.

So, our end result is that a block of mass m , on a frictionless horizontal surface, a block that is attached to a wall by an ideal massless horizontal spring, and released, at time $t=0$, from rest, from a position $x = x_{\max}$, a distance x_{\max} from its equilibrium position; will oscillate about the

equilibrium position with a period $T = 2\pi\sqrt{\frac{m}{k}}$. Furthermore, the block's position as a function of time will be given by

$$x = x_{\max} \cos\left(\frac{2\pi \text{ rad}}{T}t\right) \quad (27-4)$$

From this expression for $x(t)$ we can derive an expression for the velocity $v(t)$ as follows:

$$\begin{aligned} v &= \frac{dx}{dt} \\ v &= \frac{d}{dt} \left[x_{\max} \cos\left(\frac{2\pi \text{ rad}}{T}t\right) \right] \\ v &= x_{\max} \left[-\sin\left(\frac{2\pi \text{ rad}}{T}t\right) \right] \frac{2\pi \text{ rad}}{T} \\ v &= -x_{\max} \frac{2\pi \text{ rad}}{T} \sin\left(\frac{2\pi \text{ rad}}{T}t\right) \end{aligned} \quad (27-5)$$

And from this expression for $v(t)$ we can get the acceleration $a(t)$ as follows:

$$\begin{aligned} a &= \frac{dv}{dt} \\ a &= \frac{d}{dt} \left[-x_{\max} \frac{2\pi \text{ rad}}{T} \sin\left(\frac{2\pi \text{ rad}}{T}t\right) \right] \\ a &= -x_{\max} \frac{2\pi \text{ rad}}{T} \left[\cos\left(\frac{2\pi \text{ rad}}{T}t\right) \right] \frac{2\pi \text{ rad}}{T} \\ a &= -x_{\max} \left(\frac{2\pi \text{ rad}}{T}\right)^2 \cos\left(\frac{2\pi \text{ rad}}{T}t\right) \end{aligned} \quad (27-6)$$

Note that this latter result is consistent with the relation $a = -\frac{k}{m}x$ between a and x that we derived from Newton's 2nd Law near the start of this chapter. Recognizing that the $x_{\max} \cos\left(\frac{2\pi \text{ rad}}{T}t\right)$ is x and that the $\left(\frac{2\pi \text{ rad}}{T}\right)^2$ is $\frac{k}{m}$, it is clear that equation 27-6 is the same thing as

$$a = -\frac{k}{m}x \quad (27-7)$$

Frequency

The period T has been defined to be the time that it takes for one complete oscillation. In SI units we can think of it as the number of seconds per oscillation. The reciprocal of T is thus the number of oscillations per second. This is the rate at which oscillations occur. We give it a name, frequency, and a symbol, f .

$$f = \frac{1}{T} \quad (27-8)$$

The units work out to be $\frac{1}{\text{s}}$ which we can think of as $\frac{\text{oscillations}}{\text{s}}$ as the oscillation, much like the radian is a marker rather than a true unit. A special name has been assigned to the SI unit of frequency, $1 \frac{\text{oscillation}}{\text{s}}$ is defined to be 1 hertz, abbreviated 1 Hz. You can think of 1 Hz as either $1 \frac{\text{oscillation}}{\text{s}}$ or simply $1 \frac{1}{\text{s}}$.

In terms of frequency, rather than period, we can use $f = \frac{1}{T}$ to express all our previous results in terms of f rather than t .

$$f = \frac{1}{2\pi} \sqrt{\frac{k}{m}}$$

$$x = x_{\max} \cos(2\pi \text{ rad } f t)$$

$$v = -2\pi f x_{\max} \sin(2\pi \text{ rad } f t)$$

$$a = -(2\pi f)^2 x_{\max} \cos(2\pi \text{ rad } f t)$$

By inspection of the expressions for the velocity and acceleration above we see that the greatest possible value for the velocity is $2\pi f x_{\max}$ and the greatest possible value for the acceleration is $(2\pi f)^2 x_{\max}$. Defining

$$v_{\max} = x_{\max} (2\pi f) \quad (27-9)$$

and

$$a_{\max} = x_{\max} (2\pi f)^2 \quad (27-10)$$

and, omitting the units “rad” from the phase (thus burdening the user with remembering that the units of the phase are radians while making the expressions a bit more concise) we have:

$$x = x_{\max} \cos(2\pi f t) \quad (27-11)$$

$$v = -v_{\max} \sin(2\pi f t) \quad (27-12)$$

$$a = -a_{\max} \cos(2\pi f t) \quad (27-13)$$

The Simple Harmonic Equation

When the motion of an object is sinusoidal as in $x = x_{\max} \cos(2\pi f t)$, we refer to the motion as simple harmonic motion. In the case of a block on a spring we found that

$$a = -|\text{constant}| x \quad (27-14)$$

where the |constant| was $\frac{k}{m}$ and was shown to be equal to $(2\pi f)^2$. Written as

$$\frac{d^2 x}{dt^2} = -(2\pi f)^2 x \quad (27-15)$$

the equation is a completely general equation, not specific to a block on a spring. Indeed, any time you find that, for any system, the second derivative of the position variable, with respect to time, is equal to a negative constant times the position variable itself, you are dealing with a case of simple harmonic motion, and you can equate the absolute value of the constant to $(2\pi f)^2$.

28 Oscillations: The Simple Pendulum, Energy in Simple Harmonic Motion

*Starting with the pendulum bob at its highest position on one side, the period of oscillations is the time it takes for the bob to swing all the way to its highest position on the other side **and** back again. Don't forget that part about "and back again."*

By definition, a simple pendulum consists of a particle of mass m suspended by a massless unstretchable string of length L in a region of space in which there is a uniform constant gravitational field, e.g. near the surface of the earth. The suspended particle is called the pendulum bob. Here we discuss the motion of the bob. While the results to be revealed here are most precise for the case of a point particle, they are good as long as the length of the pendulum (from the fixed top end of the string to the center of mass of the bob) is large compared to a characteristic dimension (such as the diameter if the bob is a sphere or the edge length if it is a cube) of the bob. (Using a pendulum bob whose diameter is 10% of the length of the pendulum (as opposed to a point particle) introduces a 0.05% error. You have to make the diameter of the bob 45% of the pendulum length to get the error up to 1%.)

If you pull the pendulum bob to one side and release it, you find that it swings back and forth. It oscillates. At this point, you don't know whether or not the bob undergoes simple harmonic motion, but you certainly know that it oscillates. To find out if it undergoes simple harmonic motion, all we have to do is to determine whether its acceleration is a negative constant times its position. Because the bob moves on an arc rather than a line, it is easier to analyze the motion using angular variables.

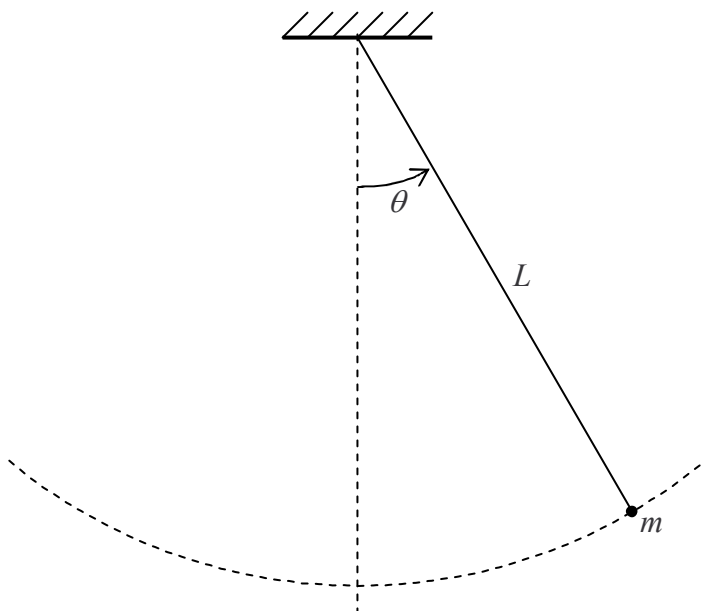

The bob moves on the lower part of a vertical circle that is centered at the fixed upper end of the string. We'll position ourselves such that we are viewing the circle, face on, and adopt a coordinate system, based on our point of view, which has the reference direction straight

downward, and for which positive angles are measured counterclockwise from the reference direction. Referring to the diagram above, we now draw a pseudo free-body diagram (the kind we use when dealing with torque) for the string-plus-bob system.

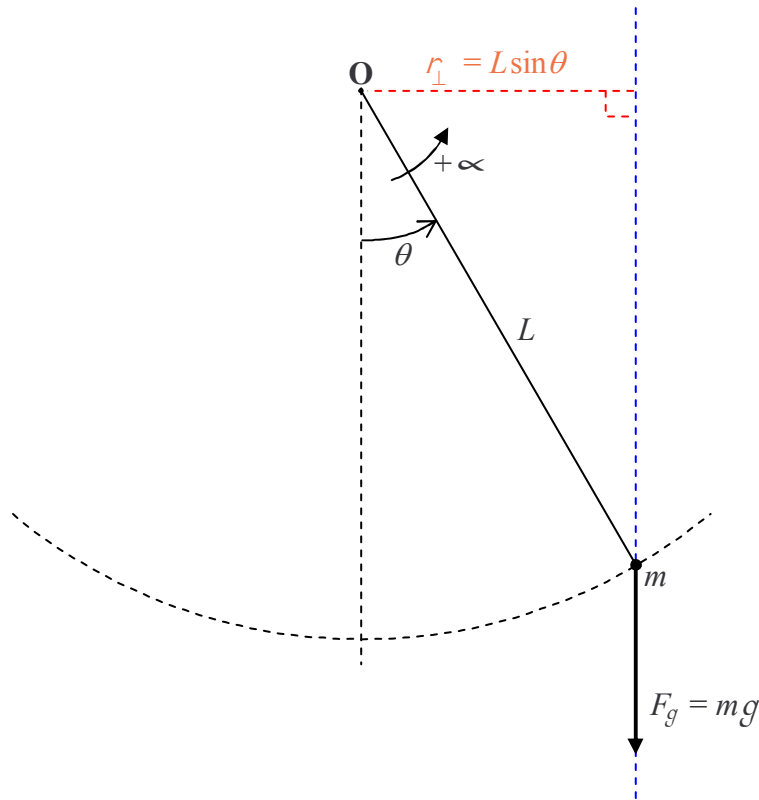

We consider the counterclockwise direction to be the positive direction for all the rotational motion variables. Applying Newton's 2nd Law for Rotational Motion, yields:

$$\alpha_{o5} = \frac{\sum \tau_{o5}}{I}$$

$$\alpha = \frac{-mgL \sin\theta}{I}$$

Next we implement the small angle approximation. Doing so means our result is approximate and that the smaller the maximum angle achieved during the oscillations, the better the approximation. According to the small angle approximation, with it understood that θ must be in radians, $\sin\theta \approx \theta$. Substituting this into our expression for α , we obtain:

$$\alpha = \frac{-mgL\theta}{I}$$

Here comes the part where we treat the bob as a point particle. The moment of inertia of a point particle, with respect to an axis that is a distance L away, is given by $I = mL^2$. Substituting this into our expression for α we arrive at:

$$\propto = \frac{-mgL}{mL^2}\theta$$

Something profound occurs in our simplification of this equation. The masses cancel out. The mass that determines the driving force behind the motion of the pendulum (the gravitational force $F_g = mg$) in the numerator, is exactly canceled by the inertial mass of the bob in the denominator. The motion of the bob does not depend on the mass of the bob! Simplifying the expression for \propto yields:

$$\propto = -\frac{g}{L}\theta$$

Recalling that $\propto \equiv \frac{d^2\theta}{dt^2}$, we have:

$$\frac{d^2\theta}{dt^2} = -\frac{g}{L}\theta \quad (28-1)$$

Hey, this is the simple harmonic motion equation, which, in generic form, appears as

$\frac{d^2x}{dt^2} = -|\text{constant}|x$ (equation 27-14) in which the $|\text{constant}|$ can be equated to $(2\pi f)^2$ where f is the frequency of oscillations. The position variable in our equation may not be x , but we still have the second derivative of the position variable being equal to the negative of a constant times the position variable itself. That being the case, number 1: we do have simple harmonic motion, and number 2: the constant $\frac{g}{L}$ must be equal to $(2\pi f)^2$.

$$\frac{g}{L} = (2\pi f)^2$$

Solving this for f , we find that the frequency of oscillations of a simple pendulum is given by

$$f = \frac{1}{2\pi} \sqrt{\frac{g}{L}} \quad (28-2)$$

Again we call your attention to the fact that the frequency does not depend on the mass of the bob!

$T = \frac{1}{f}$ as in the case of the block on a spring. This relation between T and f is a definition that applies to any oscillatory motion (even if the motion is not simple harmonic motion).

All the other formulas for the simple pendulum can be transcribed from the results for the block on a spring by writing

θ in place of x ,
 ω in place of v , and
 α in place of a .

Thus,

$$\theta = \theta_{\max} \cos(2\pi f t) \quad (28-3)$$

$$\omega = -\omega_{\max} \sin(2\pi f t) \quad (28-4)$$

$$\alpha = -\alpha_{\max} \cos(2\pi f t) \quad (28-5)$$

$$\omega_{\max} = (2\pi f) \theta_{\max} \quad (28-6)$$

$$\alpha_{\max} = (2\pi f)^2 \theta_{\max} \quad (28-7)$$

Energy Considerations in Simple Harmonic Motion

Let's return our attention to the block on a spring. A person pulls the block out away from the wall a distance x_{\max} from the equilibrium position, and releases the block from rest. At that instant, before the block picks up any speed at all, (but when the person is no longer affecting the motion of the block) the block has a certain amount of energy E . And since we are dealing with an ideal system (no friction, no air resistance) the system has that same amount of energy from then on. In general, while the block is oscillating, the energy

$$E = K + U$$

is partly kinetic energy $K = \frac{1}{2} m v^2$ and partly spring potential energy $U = \frac{1}{2} k x^2$. The amount of each varies, but the total remains the same. At time 0, the K in $E = K + U$ is zero since the velocity of the block is zero. So, at time 0:

$$E = U$$

$$E = \frac{1}{2} k x_{\max}^2$$

An endpoint in the motion of the block is a particularly easy position at which to calculate the total energy since all of it is potential energy.

As the spring contracts, pulling the block toward the wall, the speed of the block increases so, the kinetic energy increases while the potential energy $U = \frac{1}{2} k x^2$ decreases because the spring becomes less and less stretched. On its way toward the equilibrium position, the system has both kinetic and potential energy

$$E = K + U$$

with the kinetic energy K increasing and the potential energy U decreasing. Eventually the block reaches the equilibrium position. For an instant, the spring is neither stretched nor compressed and hence it has no potential energy stored in it. All the energy (the same total that we started with) is in the form of kinetic energy, $K = \frac{1}{2} m v^2$.

$$E = K + \cancel{U} \quad 0$$

$$E = K$$

The block keeps on moving. It overshoots the equilibrium position and starts compressing the spring. As it compresses the spring, it slows down. Kinetic energy is being converted into spring potential energy. As the block continues to move toward the wall, the ever-the-same value of total energy represents a combination of kinetic energy and potential energy with the kinetic energy decreasing and the potential energy increasing. Eventually, at its closest point of approach to the wall, its maximum displacement in the $-x$ direction from its equilibrium position, at its turning point, the block, just for an instant has a velocity of zero. At that instant, the kinetic energy is zero and the potential energy is at its maximum value:

$$E = \cancel{K} + U \quad 0$$

$$E = U$$

Then the block starts moving out away from the wall. Its kinetic energy increases as its potential energy decreases until it again arrives at the equilibrium position. At that point, by definition, the spring is neither stretched nor compressed so the potential energy is zero. All the energy is in the form of kinetic energy. Because of its inertia, the block continues past the equilibrium position, stretching the spring and slowing down as the kinetic energy decreases while, at the same rate, the potential energy increases. Eventually, the block is at its starting point, again just for an instant, at rest, with no kinetic energy. The total energy is the same total as it has been throughout the oscillatory motion. At that instant, the total energy is all in the form of potential energy. The conversion of energy, back and forth between the kinetic energy of the block and the potential energy stored in the spring, repeats itself over and over again as long as the block continues to oscillate (with—and this is indeed an idealization—no loss of mechanical energy).

A similar description, in terms of energy, can be given for the motion of an ideal (no air resistance, completely unstretchable string) simple pendulum. The potential energy, in the case of the simple pendulum, is in the form of gravitational potential energy $U = mgy$ rather than spring potential energy. The one value of total energy that the pendulum has throughout its oscillations is all potential energy at the endpoints of the oscillations, all kinetic energy at the midpoint, and a mix of potential and kinetic energy at locations in between.

29 Waves: Characteristics, Types, Energy

Consider a long taut horizontal string of great length. Suppose one end is in the hand of a person and the other is fixed to an immobile object. Now suppose that the person moves her hand up and down. The person causes her hand, and her end of the string, to oscillate up and down. To discuss what happens, we, in our mind, consider the string to consist of a large number of very short string segments. It is important to keep in mind that the force of tension of a string segment exerted on any object, including another segment of the string, is directed away from the object *along the string segment* that is exerting the force. (The following discussion and diagrams are intentionally oversimplified. The discussion *does* correctly give the gross idea of how oscillations at one end of a taut string can cause a pattern to move along the length of the string despite the fact that the individual bits of string are essentially doing nothing more than moving up and down.

The person is holding one end of the first segment. She first moves her hand upward.



This tilts the first segment so that the force of tension that it is exerting on the second segment has an upward component.



This, in turn, tilts the second segment so that its force of tension on the third segment now has an upward component. The process continues with the 3rd segment, the 4th segment, etc.



After reaching the top of the oscillation, the person starts moving her hand downward. She moves the left end of the first segment downward, but by this time, the first four segments have an upward velocity. Due to their inertia, they continue to move upward. The downward pull of the first segment on the left end of the second segment causes it to slow down, come to rest,



and eventually start moving downward. Inertia plays a huge role in wave propagation. “To propagate” means “to go” or “to travel.” Waves propagate through a medium.

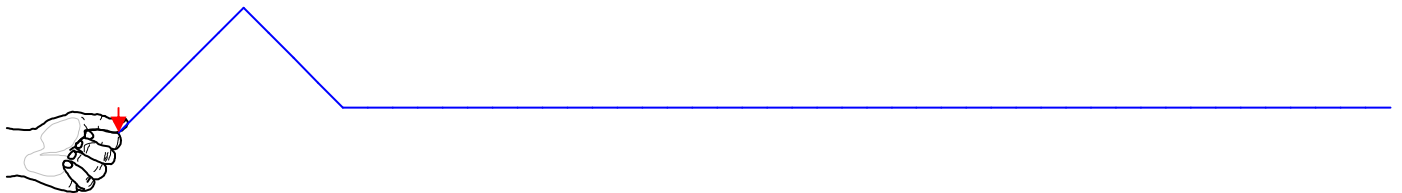
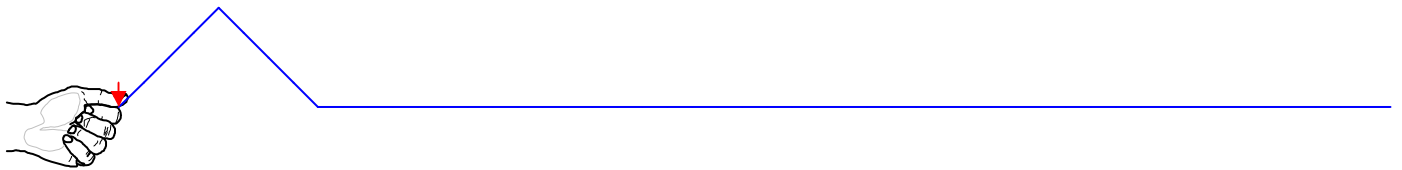
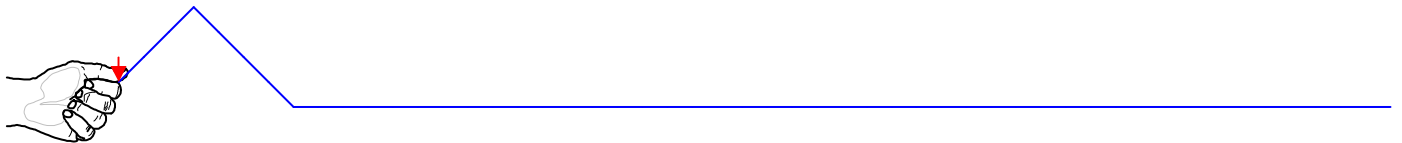

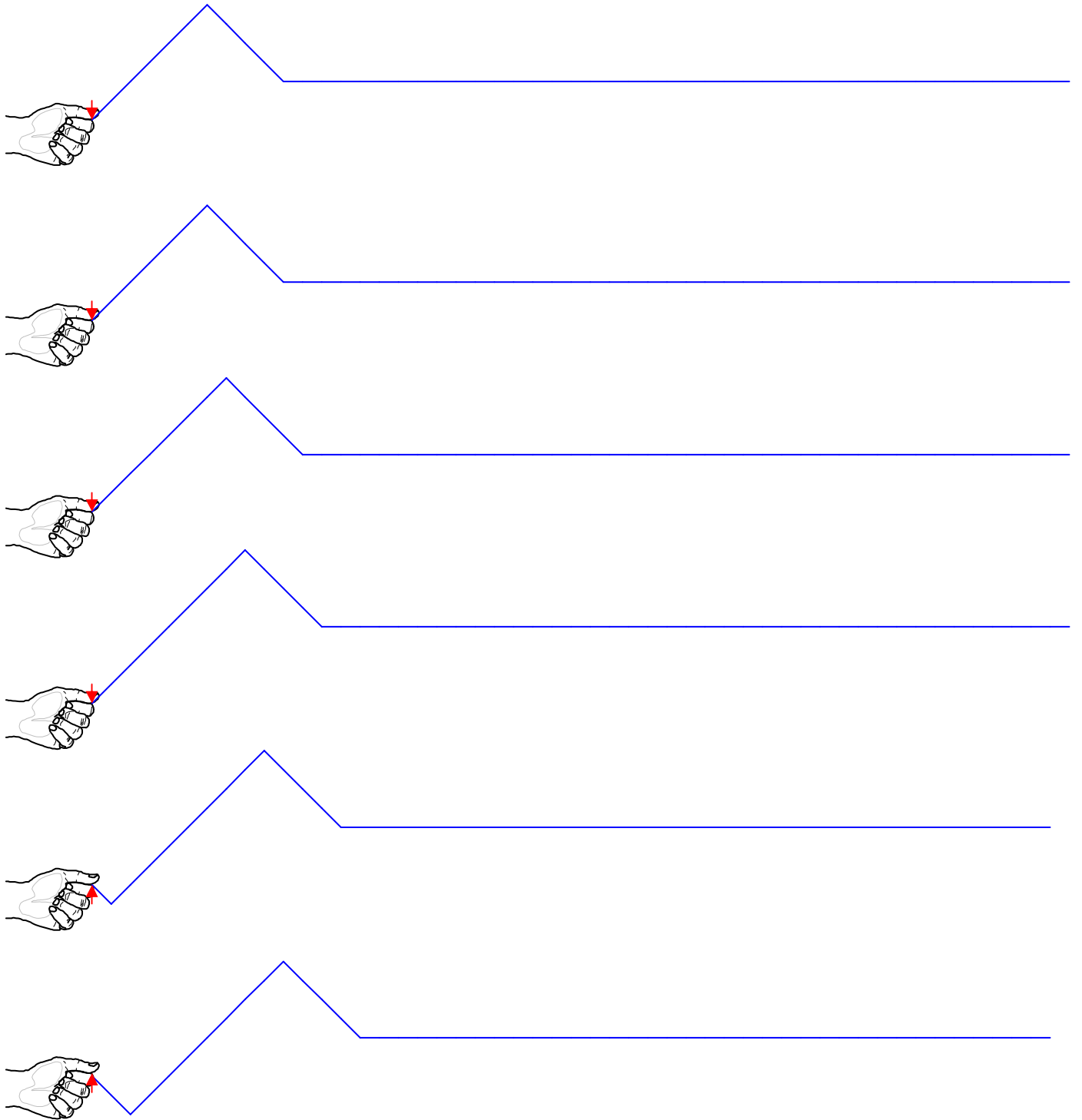

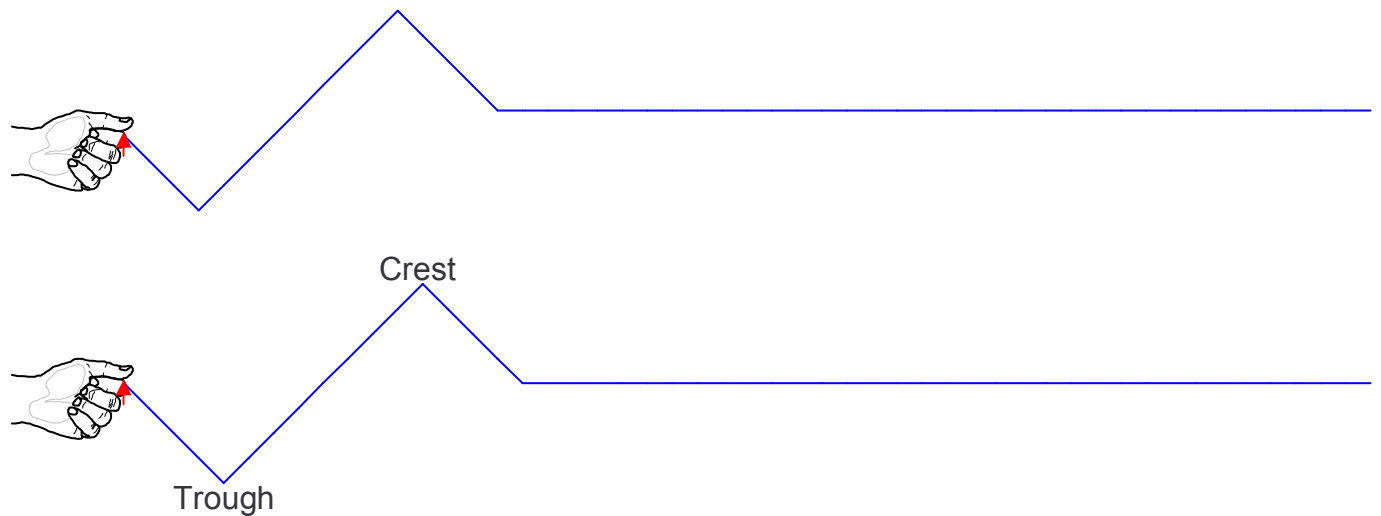

Each very short segment of the string undergoes oscillatory motion like that of the hand, but for any given section, the motion is delayed relative to the motion of the neighboring segment that is closer to the hand. The net effect of all these string segments oscillating up and down, each with the same frequency but slightly out of synchronization with its nearest neighbor, is to create a disturbance in the string. Without the disturbance, the string would just remain on the original horizontal line. The disturbance moves along the length of the string, away from the hand. The disturbance is called a wave. An observer, looking at the string from the side sees crests and troughs of the disturbance, moving along the length of the string, away from the hand. Despite appearances, no material is moving along the length of the string, just a disturbance. The illusion that actual material is moving along the string can be explained by the timing with which the individual segments move up and down, each about its own equilibrium position, the position it was in before the person started making waves.

Wave Characteristics

In our pictorial model above, we depicted a hand that was oscillating but not undergoing simple harmonic motion. If the oscillations that are causing the wave do conform to simple harmonic motion, then each string segment making up the string will experience simple harmonic motion (up and down). When individual segments making up the string are each undergoing simple harmonic motion, the wave pattern is said to vary sinusoidally in both time and space. We can tell that it varies sinusoidally in space because a graph of the displacement y , the distance that a given point on the string is above its equilibrium position, versus x , how far from the end of the string the point on the string is; is sinusoidal.

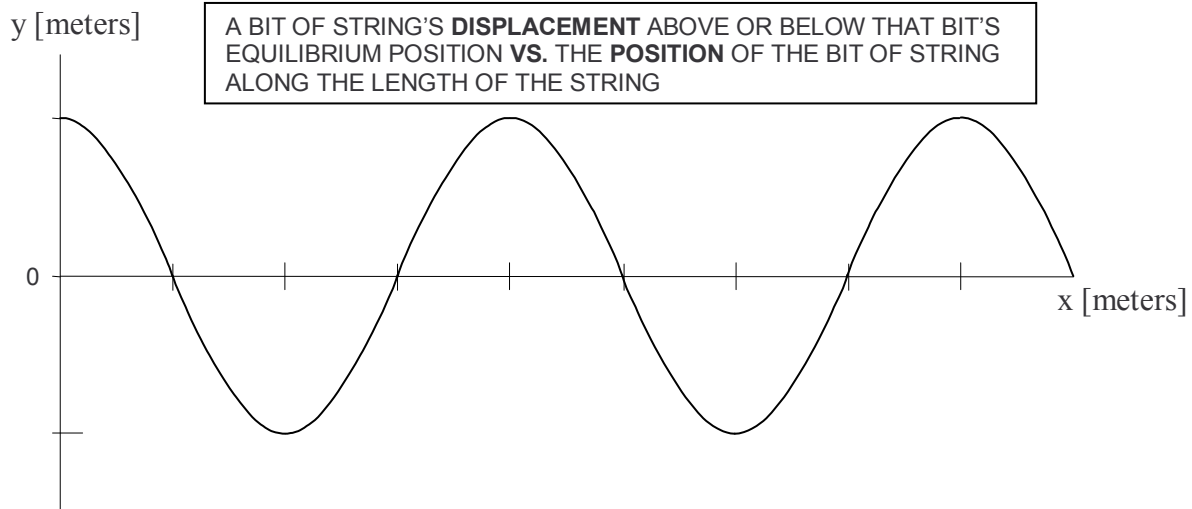

We say that the wave varies sinusoidally with time because, for any point along the length of the string, a graph of the displacement of that point from its equilibrium position vs. time is sinusoidal:

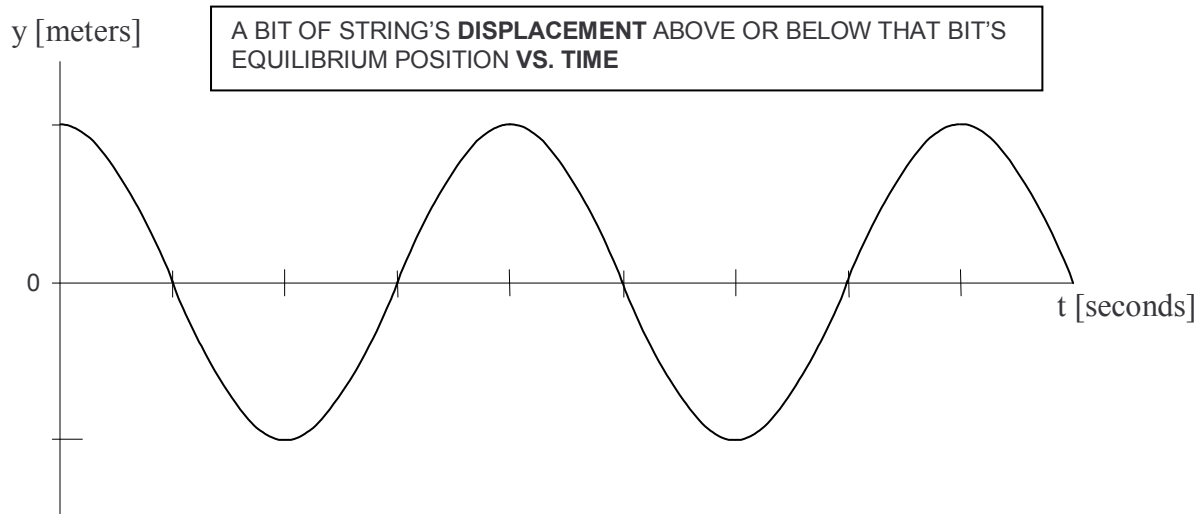

There are a number of ways of characterizing the wave-on-a-string system. You could probably come up with a rather complete list yourself: the rate at which the oscillations are occurring, how long it takes for a given tiny segment of the string to complete one oscillation, how big the oscillations are, the smallest length of the unique pattern which repeats itself in space, and the speed at which the wave pattern travels along the length of the string. Physicists have, of course, given names to the various quantities, in accordance with that important lowest level of scientific activity—naming and categorizing the various characteristics of that aspect of the natural world which is under study. Here are the names:

Amplitude

Any particle of a string with waves traveling through it undergoes oscillations. Such a particle goes away from its equilibrium position until it reaches its maximum displacement from its equilibrium position. Then it heads back toward its equilibrium position and then passes right through the equilibrium position on its way to its maximum displacement from equilibrium on the other side of its equilibrium position. Then it heads back toward the equilibrium position and passes through it again. This motion repeats itself continually as long as the waves are traveling through the location of the particle of the string in question. The maximum displacement of any particle along the length of the string, from that point's equilibrium position, is called the *amplitude* y_{\max} of the wave.

The amplitude can be annotated on both of the two kinds of graphs given above (Displacement vs. Position, and Displacement vs. Time). Here we annotate it on the Displacement vs. Position graph:

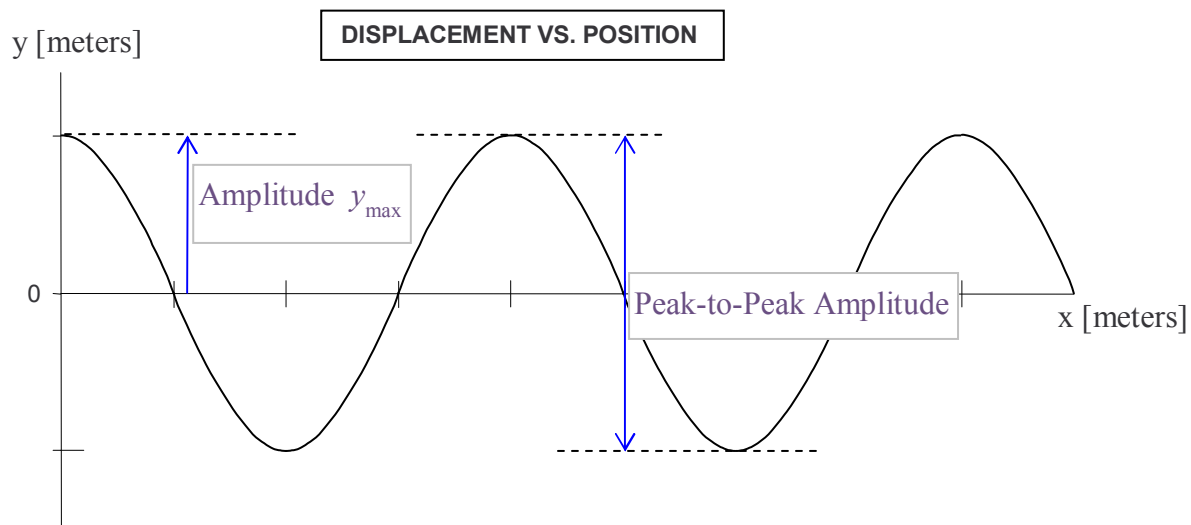

The peak-to-peak amplitude, a quantity that is often easier to measure than the amplitude itself, has also been annotated on the graph. It should be obvious that the peak-to-peak amplitude is twice the amplitude.

Period

The amount of time that it takes any one particle along the length of the string to complete one oscillation is called the period T . Note that the period is completely determined by the source of the waves. The time it takes for the source of the waves to complete one oscillation is equal to the time it takes for any particle of the string to complete one oscillation. That time is the period of the wave. The period, being an amount of time, can only be annotated on the Displacement vs. Time graph (not on the Displacement vs. Position Along the String graph).

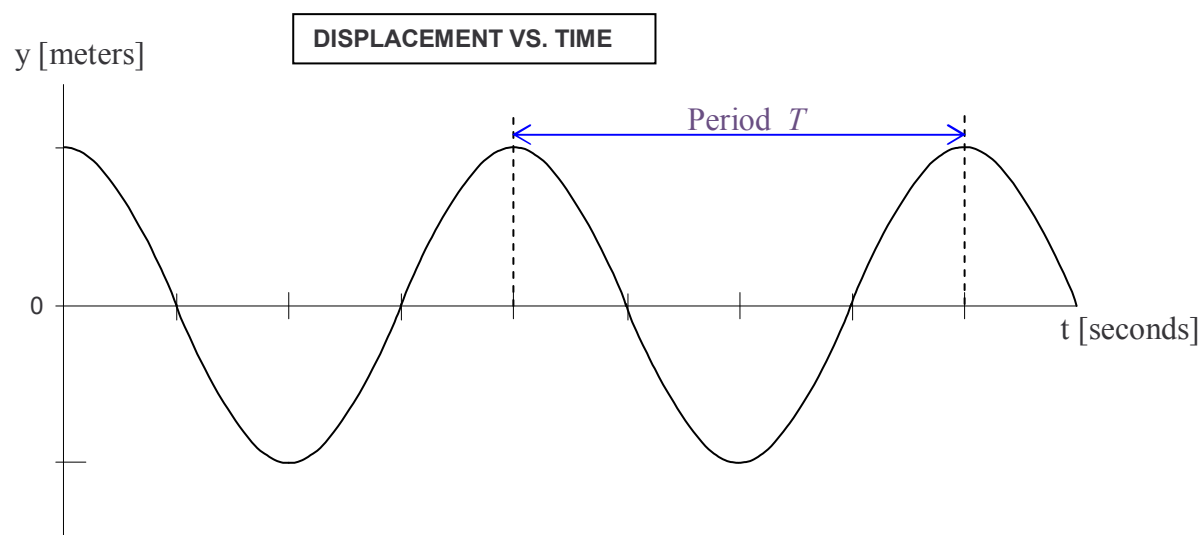

Frequency

The frequency f is the number-of-oscillations-per-second that any particle along the length of the string undergoes. It is the oscillation rate. Since it is the number-of-oscillations-per-second and the period is the number-of-seconds-per-oscillation, the frequency f is simply the reciprocal of the period T : $f = \frac{1}{T}$.

Amplitude, period, and frequency are quantities that you learned about in your study of oscillations. Here, they characterize the oscillations of a point on a string. Despite the fact that the string as a whole is undergoing wave motion, the fact that the point itself, any point along the length of the string, is simply oscillating, means that the definitions of amplitude, period, and frequency are the same as the definitions given in the chapter on oscillations. Thus, our discussion of amplitude, period, and frequency represents a review. Now, however, it is time to move on to something new, a quantity that does not apply to simple harmonic motion but does apply to waves.

Wavelength

The distance over which the wave pattern repeats itself once, is called the wavelength λ of the wave. Because the wavelength is a distance measured along the length of the string, it can be annotated on the Displacement vs. Position Along the String graph (but not on the Displacement vs. Time graph):

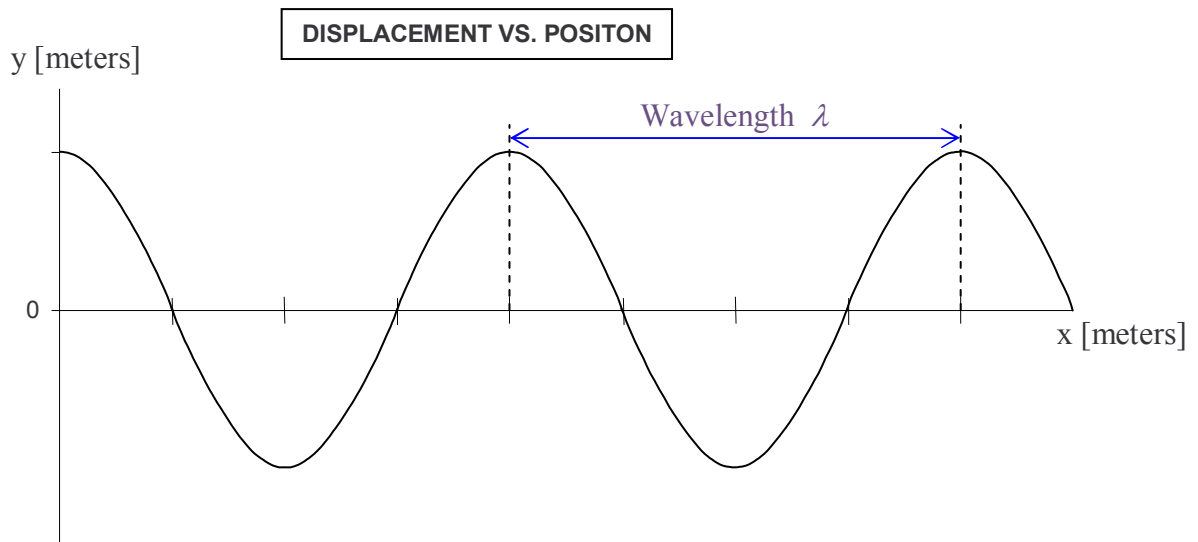

Wave Velocity

The wave velocity is the speed and direction with which the wave pattern is traveling. (It is NOT the speed with which the particles making up the string are traveling in their up and down motion.) The direction part is straightforward, the wave propagates along the length of the string, away from the cause (something oscillating) of the wave. The wave speed (the constant speed with which the wave propagates) can be expressed in terms of other quantities that we have just discussed.

To get at the wave speed, what we need to do is to correlate the up-and-down motion of a point on the string, with the motion of the wave pattern moving along the string. Consider the following Displacement vs. Position graph for a wave traveling to the right. In the diagram, I have shaded in one cycle of the wave, marked off a distance of one wavelength, and drawn a dot at a point on the string whose motion we shall keep track of.

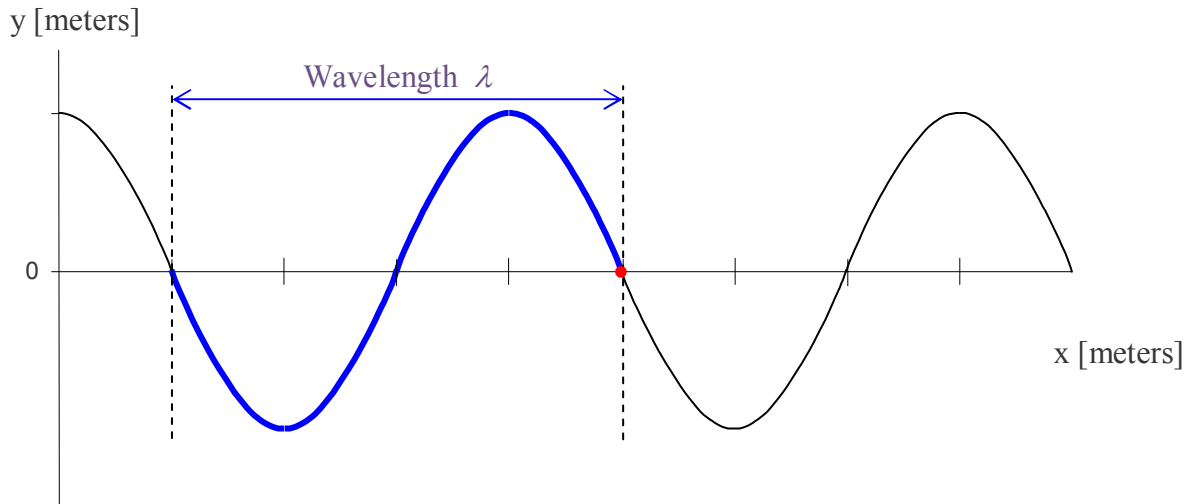

Now, let's allow some time to elapse, just enough time for the wave to move over one quarter of a wavelength.

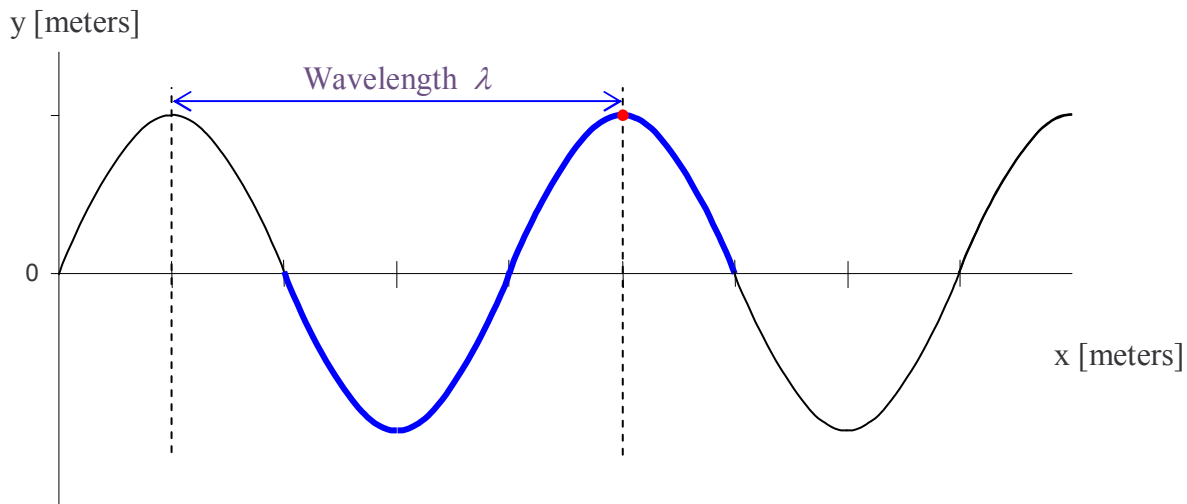

In that time we note that the point on the string marked by the dot has moved from its equilibrium position to its maximum displacement from equilibrium position. As the wave has moved over one quarter of a wavelength, the point on the string has completed one quarter of an oscillation.

Let's allow the same amount of time to elapse again, the time it takes for the wave to move over one quarter of a wavelength.

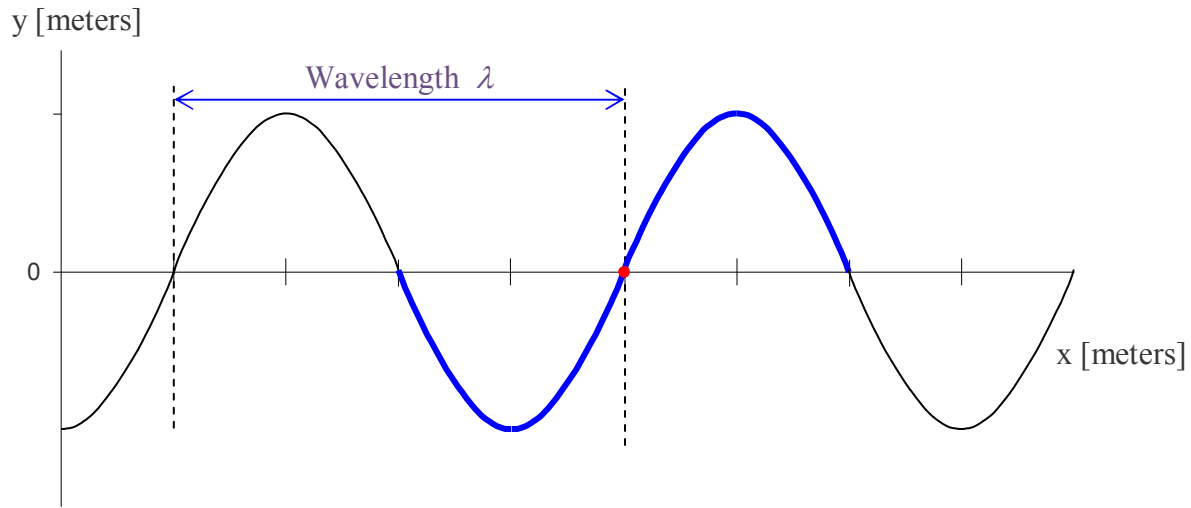

At this point, the wave has moved a total of a half a wavelength over to the right, and the point on the string marked by the dot has moved from its equilibrium position up to its position of maximum positive displacement and back to its equilibrium position; that is to say, it has completed half of an oscillation.

Let's let the same amount of time elapse again, enough time for the wave pattern to move over another quarter of a wavelength.

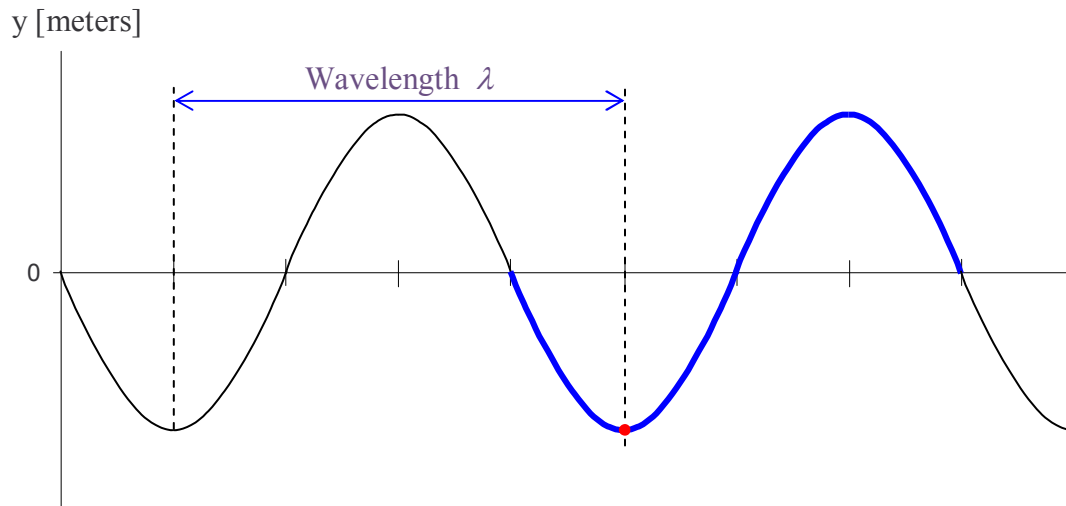

The wave has moved over a total distance of three quarters of a wavelength and the point on the string that is marked with a dot has moved on to its maximum negative (downward) displacement from equilibrium meaning that it has completed three quarters of an oscillation.

Now we let the same amount of time elapse once more, the time it takes for the wave to move over one quarter of a wavelength.

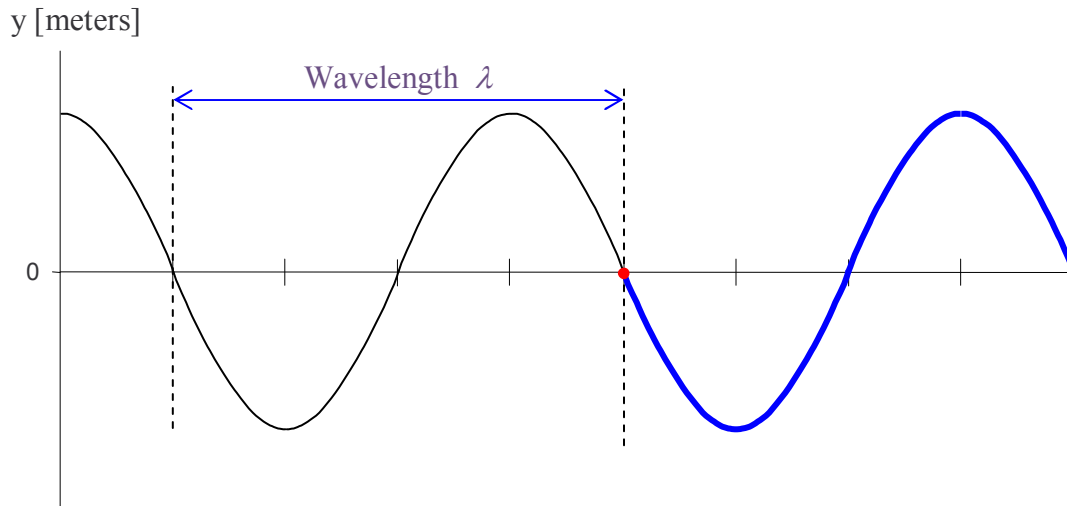

At this point, the wave has moved over a distance equal to one wavelength and the point on the string marked by a dot has completed one oscillation. It is that point of the string whose motion we have been keeping track of that gives us a handle on the time. The amount of time that it takes for the point on the string to complete one oscillation is, by definition, the period of the wave. Now we know that the wave moves a distance of one wavelength λ in a time interval equal to one period T . For something moving with a constant speed (zero acceleration), the speed is simply the distance traveled during a specified time interval divided by the duration of that time interval. So, we have, for the wave speed v :

$$v = \frac{\lambda}{T} \quad (29-1)$$

One typically sees the formula for the wave speed expressed as

$$v = \lambda f \quad (29-2)$$

where the relation $f = \frac{1}{T}$ between frequency and period has been used to eliminate the period.

Equation 29-2 ($v = \lambda f$) suggests that the wave speed depends on the frequency and the wavelength. This is not at all the case. Indeed, as far as the wavelength is concerned, it is the other way round—the oscillator that is causing the waves determines the frequency, and the corresponding wavelength depends on the wave speed. The wave speed is predetermined by the characteristics of the string—how taut it is, and how much mass is packed into each millimeter of it. Looking back on our discussion of how oscillations at one end of a taut string result in waves propagating through it, you can probably deduce that the greater the tension in the string, the faster the wave will move along the string. When the hand moves the end of the first segment up, the force exerted on the second segment of the string by the first segment will be greater, the greater the tension in the string. Hence the second segment will experience a greater

acceleration. This goes for all the segments down the line. The greater the acceleration, the faster the segments pick up speed and the faster the disturbance, the wave, propagates along the string—that is, the greater the wave speed. We said that the wave speed also depends on the amount of mass packed into each millimeter of the string. This refers to the linear density μ , the mass-per-length, of the string. The greater the mass-per-length, the greater the mass of each segment of the string and the less rapidly the velocity will be changing for a given force. Here we provide, with no proof, the formula for the speed of a wave in a string as a function of the string characteristics, tension F_T and linear mass density μ :

$$v = \sqrt{\frac{F_T}{\mu}} \quad (29-3)$$

Note that this expression agrees with the conclusions that the greater the tension, the greater the wave speed; but the greater the linear mass density, the smaller the wave speed.

Kinds of Waves

We've been talking about a wave in a string. Lots of other media, besides strings, support waves as well. You have probably heard, and probably heard *of*, sound waves in air. Sound waves travel through other gases and they travel through liquids and solids as well. Perhaps you have heard of seismic waves as well, the waves that travel through the earth when earthquakes occur. All of these waves fall into one of two categories. Which category is determined by the orientation of the lines along which the oscillations of the particles making up the medium occur relative to the direction of propagation of the waves. If the particles oscillate along lines that are perpendicular to the direction in which the wave travels, the wave is said to be a transverse wave (because transverse means perpendicular to). If the particles oscillate along a line that is along the direction in which the wave travels, the wave is said to be longitudinal. The wave in a horizontal string that we discussed at such length is an example of a transverse wave. Calling the direction in which the string extends away from the oscillator the forward direction, we discussed the case in which the particles making up the string were oscillating up and down. The wave travels along the string and the up and down directions are indeed perpendicular to the forward direction making it clear that we were dealing with transverse waves. It should be noted that the oscillations could have been from side to side or at any angle relative to the vertical as long as they were perpendicular to the string. Also, there is no stipulation that the string be horizontal in order for transverse waves to propagate in it. The string was said to be horizontal in our introduction to waves in order to simplify the discussion.

Wave Power

Consider a very long stationary string extending from left to right. Consider a very short segment of the string, call it segment A, at an arbitrary distance along the string from the left end. Now suppose that someone is holding the left end of the long string in her hand and that she starts oscillating the left end of the string up and down. As you know, a wave will travel through the string from left to right. Before it gets to segment A, segment A is at rest. After the front end of the wave gets to segment A, segment A will be oscillating up and down like a mass on a spring. Segment A has mass and it has velocity throughout most of its motion, so clearly it has energy. It had none before the wave got there, so waves must have energy. By oscillating the end of the string the person has given energy to the string and that energy travels along the string in the form of a wave. Here we give an expression for the rate at which energy propagates along the string in terms of the string and wave properties. That rate is the energy-per-time passing through any point (through which the wave is traveling) in the string. It is the power of the wave.

The analysis that yields the expression for the rate at which the energy of waves in a string passes a point on the string, that is, the power of the wave, is straightforward but too lengthy to include here. The result is:

$$P = 2\pi\sqrt{\mu F_T} f^2 y_{\max}^2$$

As regards waves in a string with a given tension and linear mass density, we note that

$$P \propto f^2 y_{\max}^2 \quad (29-4)$$

This relation applies to all kinds of waves. The constant of proportionality depends on the kind of wave that you are dealing with, but the proportionality itself applies to all kinds of waves. I was reminded of this relation by a physical therapist who was using ultrasound waves to deposit energy into my back muscles. She mentioned that a doubling of the frequency of the ultrasonic waves would provide deeper penetration of the sound waves, but that it would also result in a quadrupling of the rate at which energy would be deposited in the tissue. Hence, to deposit the same total amount of energy that she deposited at a given frequency on one occasion; a treatment at double the frequency would either last one fourth as long (at the same amplitude) or would be carried out for the same amount of time at half the amplitude.

Intensity

Consider a tiny buzzer, suspended in air by a string. Sound waves, caused by the buzzer, travel outward in all away-from-the-buzzer directions:

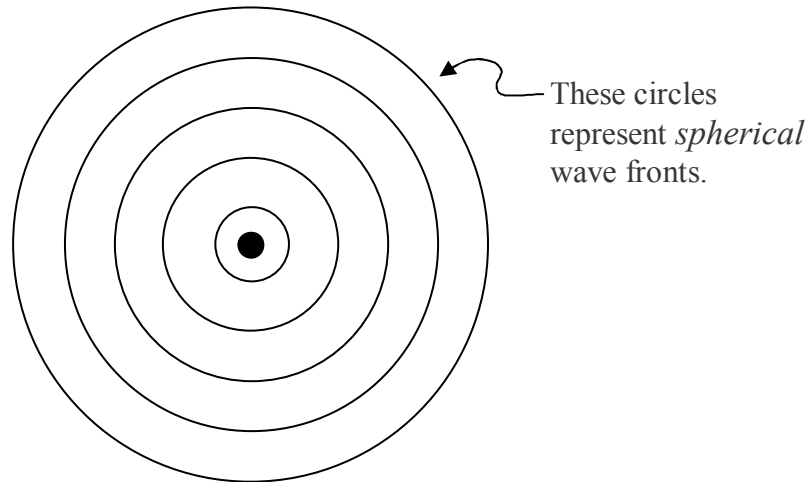

In the diagram above, the black dot represents the buzzer, and the circles represent wavefronts—collections of points in space at which the air molecules are at their maximum displacement away from the buzzer. The wavefronts are actually spherical shells. In a 3D model of them, they would be well represented by soap bubbles, one inside the other, all sharing the same center. Note that subsequent to the instant depicted, the air molecules at the location of the wavefront will start moving back toward the buzzer, in their toward and away from the buzzer oscillations, whereas the wavefront itself will move steadily outward from the buzzer as the next layer of air molecules achieves its maximum displacement position and then the next, etc.

Now consider a fixed imaginary spherical shell centered on the buzzer. The power of the wave is the rate at which energy passes through that shell. As mentioned, the power obeys the relation

$$P \propto f^2 y_{\max}^2$$

Note that the power does not depend on the size of the spherical shell; all the energy delivered to the air by the buzzer must pass through any spherical shell centered on the buzzer. But the surface of a larger spherical shell is farther from the buzzer and our experience tells us that the further you are from the buzzer the less loud it sounds suggesting that the power delivered to our ear is smaller. So how can the power for a large spherical shell (with its surface far from the source) be the same as it is for a small spherical shell? We can say that as the energy moves away from the source, it spreads out. So by the time it reaches the larger spherical shell, the power passing through, say, any square millimeter of the larger spherical shell is relatively small, but the larger spherical shell has enough more square millimeters for the total power through it to be the same.

Now imagine somebody near the source with their eardrum facing the source.

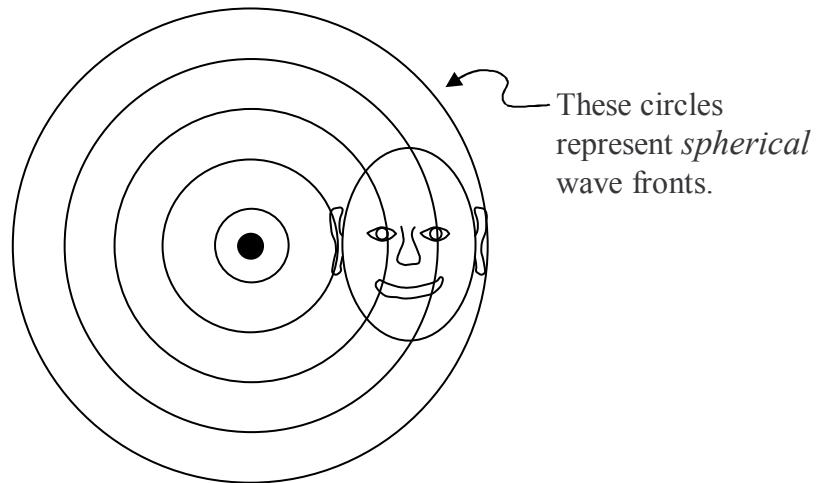

The amount of energy delivered to the ear is the power-per-area passing through the imaginary source-centered spherical shell whose surface the ear is on, times the area of the eardrum. Since the spherical shell is small, meaning it has relatively little surface area, and all the power from the source must pass through that spherical shell, the power-per-area at the location of the ear must be relatively large. Multiply that by the fixed area of the eardrum and the power delivered to the eardrum is relatively large.

If the person is farther from the source,

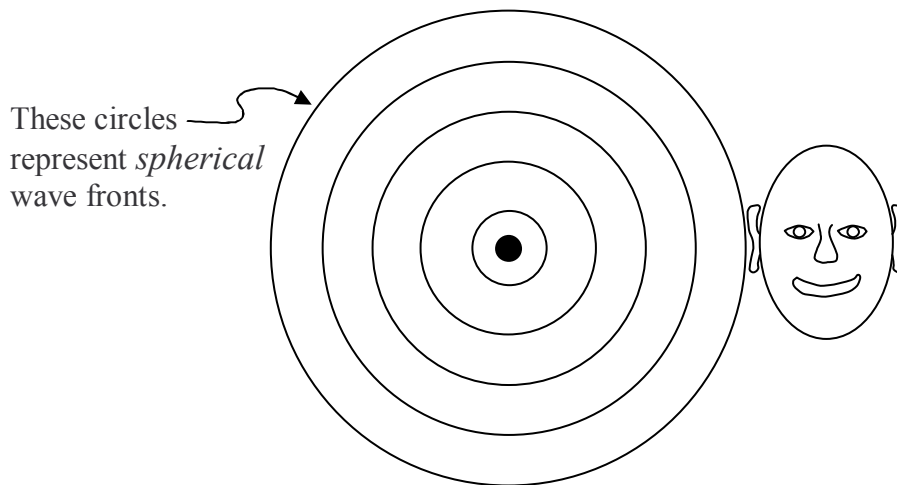

the total power from the source is distributed over the surface of a larger spherical shell so the power-per-area is smaller. Multiply that by the fixed area of the eardrum to get the power delivered to the ear. It is clear that the power delivered to the ear will be smaller. The farther the ear is from the source; the smaller is the fraction of the total power of the source, received by the eardrum.

How loud the buzzer sounds to the person is determined by the power delivered to the ear, which, we have noted, depends on the power-per-area at the location of the ear.

The power-per-area of sound waves is given a name. It is called the *intensity* of the sound. For waves in general (rather than just sound waves) we simply call it the intensity of the wave. While the concept of intensity applies to waves from any kind of source, it is particularly easy to calculate in the case of the small buzzer delivering energy uniformly in all directions. For any point in space, we create an imaginary spherical shell, through that point, centered on the buzzer. Then the intensity I at the point (and at any other point on the spherical shell) is simply the power of the source divided by the area of the spherical shell:

$$I = \frac{P}{4\pi r^2} \quad (29-5)$$

where the r is the radius of the imaginary spherical shell, but more importantly, it is the distance of the point at which we wish to know the intensity, from the source. Since $P \propto f^2 y_{\max}^2$, we have

$$I \propto \frac{f^2 y_{\max}^2}{r^2} \quad (29-6)$$

At a fixed distance from a source of a fixed frequency, recognizing that y_{\max} is the amplitude of the waves we have

$$I \propto (\text{Amplitude})^2 \quad (29-7)$$

30 Wave Function, Interference, Standing Waves

In that two of our five senses (sight and sound) depend on our ability to sense and interpret waves, and in that waves are ubiquitous, waves are of immense importance to human beings. Waves in physical media conform to a wave equation that can be derived from Newton's Second Law of motion. The wave equation reads:

$$\frac{\partial^2 y}{\partial x^2} = \frac{1}{v^2} \frac{\partial^2 y}{\partial t^2} \quad (30-1)$$

where:

- y is the displacement of a point on the medium from its equilibrium position,
- x is the position along the length of the medium,
- t is time, and
- v is the wave velocity.

Take a good look at this important equation. Because it involves derivatives, the wave equation is a differential equation. The wave equation says that the second derivative of the displacement with respect to position (treating the time t as a constant) is directly proportional to the second derivative of the displacement with respect to time (treating the position x as a constant). When you see an equation for which this is the case, you should recognize it as the wave equation.

In general, when the analysis of a continuous medium, e.g. the application of Newton's second law to the elements making up that medium, leads to an equation of the form

$$\frac{\partial^2 y}{\partial x^2} = |constant| \frac{\partial^2 y}{\partial t^2} ,$$

the constant will be an algebraic combination of physical quantities representing properties of the medium. That combination can be related to the wave velocity by

$$|constant| = \frac{1}{v^2}$$

For instance, application of Newton's Second Law to the case of a string results in a wave equation in which the constant of proportionality depends on the linear mass density μ and the string tension F_T :

$$\frac{\partial^2 y}{\partial x^2} = \frac{\mu}{F_T} \frac{\partial^2 y}{\partial t^2}$$

Recognizing that the constant of proportionality $\frac{\mu}{F_T}$ has to be equal to the reciprocal of the square of the wave velocity, we have

$$\frac{\mu}{F_T} = \frac{1}{v^2}$$

$$v = \sqrt{\frac{F_T}{\mu}} \quad (30-2)$$

relating the wave velocity to the properties of the string. The solution of the wave equation

$\frac{\partial^2 y}{\partial x^2} = \frac{1}{v^2} \frac{\partial^2 y}{\partial t^2}$ can be expressed as

$$y = y_{\max} \cos\left(\frac{2\pi}{\lambda} x \pm \frac{2\pi}{T} t + \phi\right) \quad (30-3)$$

where:

y is the displacement of a point in the medium from its equilibrium position,

y_{\max} is the amplitude of the wave,

x is the position along the length of the medium,

λ is the wavelength,

t is time,

T is the period, and

ϕ is a constant having units of radians. ϕ is called the phase constant.

A “-“ in the location of the “ \pm ” is used in the case of a wave traveling in the + x direction and a “+” for one traveling in the - x direction. Equation 30-3, the solution to the wave equation

$\frac{\partial^2 y}{\partial x^2} = \frac{1}{v^2} \frac{\partial^2 y}{\partial t^2}$, is known as the wave function. Substitute the wave function into the wave equation and verify that you arrive at

$$v = \frac{\lambda}{T},$$

a necessary condition for the wave function to actually solve the wave equation. $v = \frac{\lambda}{T}$ is the statement that the wave speed is equal to the ratio of the wavelength to the period, a relation that we derived in a conceptual fashion in the last chapter.

At position $x=0$ in the medium, at time $t=0$, the wave function, equation 30-3, evaluates to

$$y = y_{\max} \cos(\phi).$$

The phase of the cosine boils down to the phase constant ϕ whose value thus determines the value of y at $x=0$, $t=0$. (Note that the “phase” of the cosine is the argument of the cosine—that which you are taking the cosine of.) The value of the phase constant ϕ is of no relevance to our

present discussion so we arbitrarily set $\phi = 0$. Also, on your formula sheet, we write the wave function only for the case of a wave traveling in the $+x$ direction, that is, we replace the “ \pm ” with a “ $-$ ”. The wave function becomes

$$y = y_{\max} \cos\left(\frac{2\pi}{\lambda}x - \frac{2\pi}{T}t\right) \quad (30-4)$$

This is the way it appears on your formula sheet. You are supposed to know that this corresponds to a wave traveling in the $+x$ direction and that the expression for a wave traveling in the $-x$ direction can be arrived at by replacing the “ $-$ ” with a “ $+$ ”.

Interference

Consider a case in which two waveforms arrive at the same point in a medium at the same time. We'll use idealized waveforms in a string to make our points here. In the case of a string, the only way two waveforms can arrive at the same point in the medium at the same time is for the waveforms to be traveling in opposite directions:

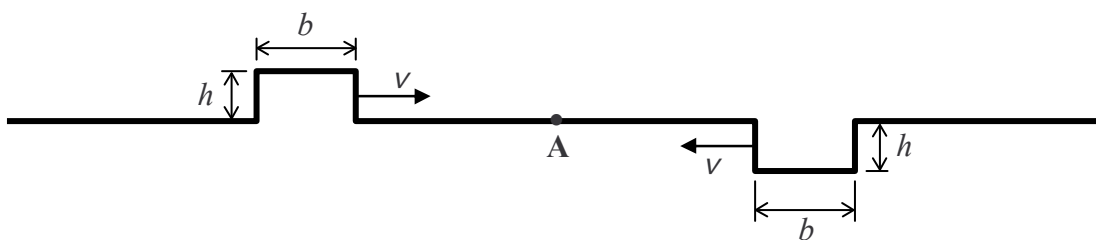

The two waveforms depicted in the diagram above are “scheduled” to arrive at point A at the same time. At that time, based on the waveform on the left alone, point A would have a displacement $+h$, and based on the waveform on the right alone, point A would have the displacement $-h$. So, what is the actual displacement of point A when both waveforms are at point A at the same time? To answer that, you simply add the would-be single-waveform displacements together algebraically (taking the sign into account). One does this point for point over the entire length of the string for any given instant in time. In the following series of diagrams we show the point-for-point addition of displacements for several instants in time.

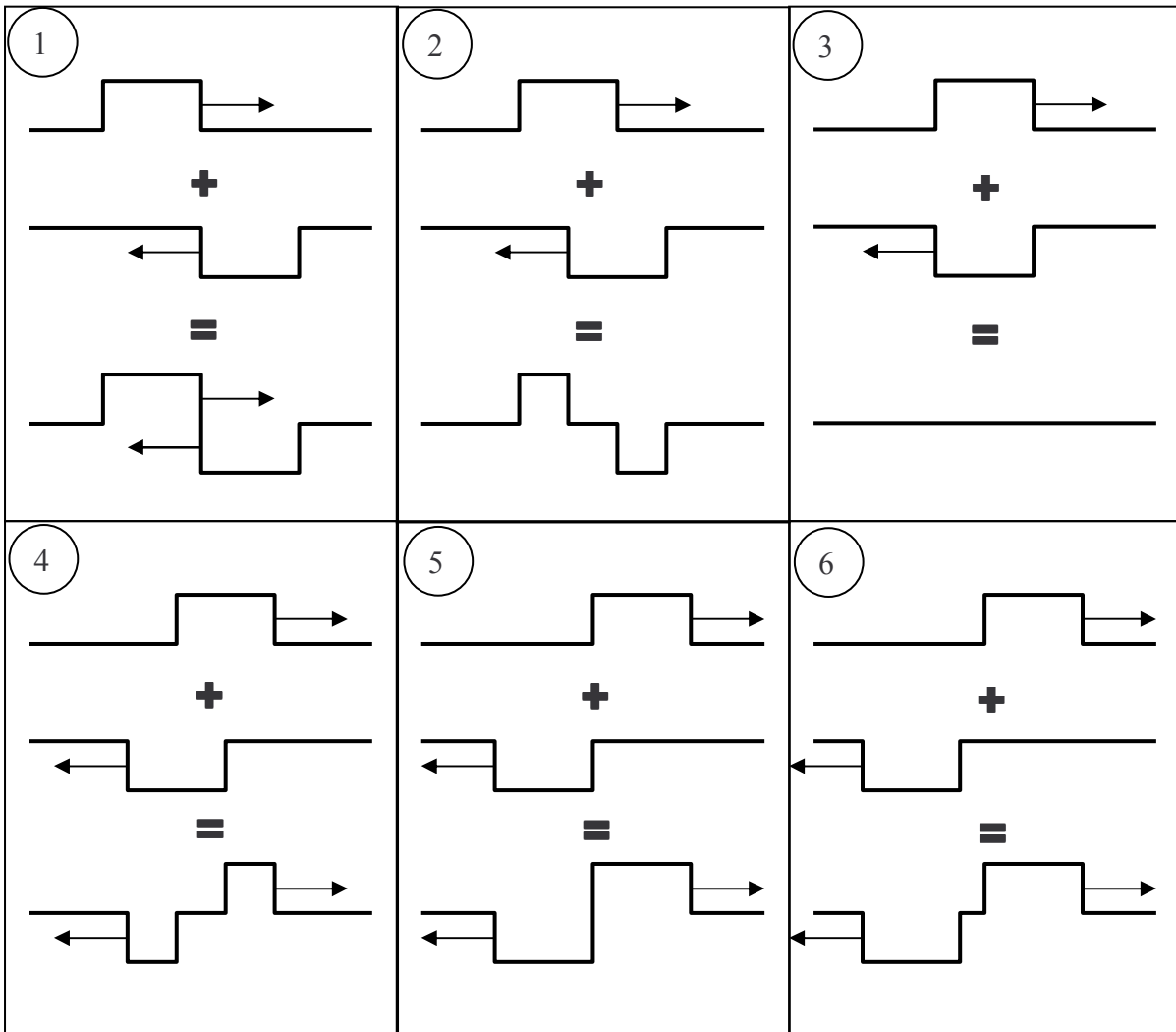

The phenomenon in which waves traveling in different directions simultaneously arrive at one and the same point in the wave medium is referred to as *interference*. When the waveforms add together to yield a bigger waveform,

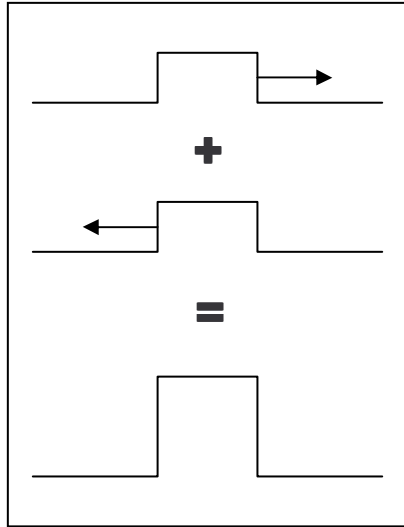

the interference is referred to as *constructive* interference. When the two waveforms tend to cancel each other out,

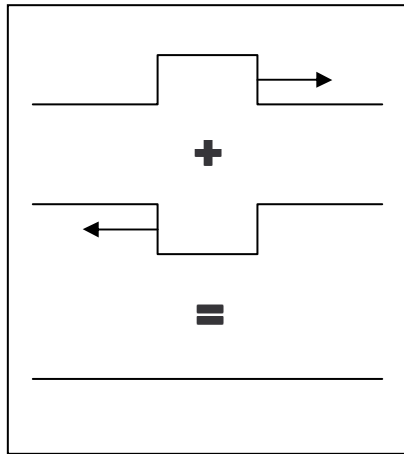

the interference is referred to as *destructive* interference.

Reflection of a Wave from the End of a Medium

Upon reflection from the fixed end of a string, the displacement of the points on a traveling waveform is reversed.

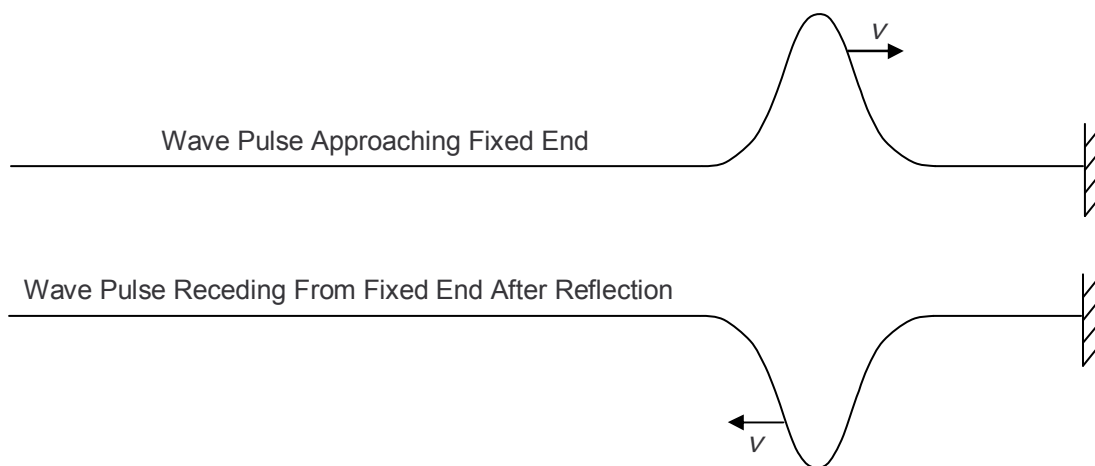

The fixed end, by definition, never undergoes any displacement.

Now we consider a free end. A fixed end is a natural feature of a taut string. A free end, on the other hand, an idealization, is at best an approximation in the case of a taut string. We approximate a free end in a physical string by means of a drastic and abrupt change in linear density. Consider a rope, one of which is attached to the wave source, and the other end of which is attached to one end of a piece of thin, but strong, fishing line. Assume that the fishing line extends through some large distance to a fixed point so that the whole system of rope plus fishing line is taut. A wave traveling along the rope, upon encountering the end of the rope attached to the thin fishing line, behaves approximately as if it has encountered a free end of a taut rope.

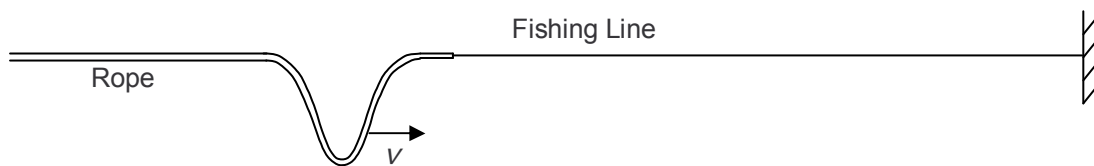

In the case of sound waves in a pipe, a free end can be approximated by an open end of the pipe.

Enough said about how one might set up a physical free end of a wave medium, what happens when a wave pulse encounters a free end? The answer is, as in the case of the fixed end, the waveform is reflected, but this time, there is no reversal of displacements.

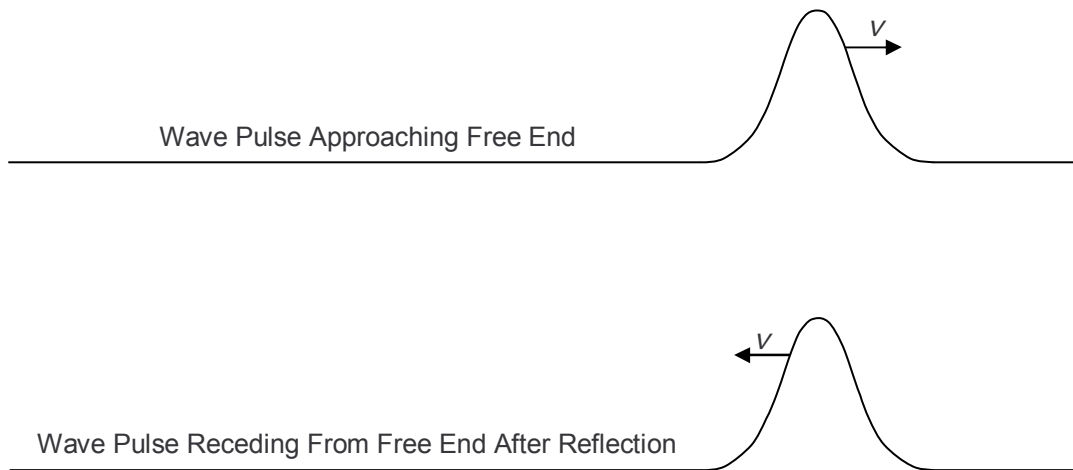

Standing Waves

Consider a piece of string, fixed at both ends, into which waves have been introduced. The configuration is rich with interference. A wave traveling toward one end of the string reflects off the fixed end and interferes with the waves that were trailing it. Then it reflects off the other end and interferes with them again. This is true for every wave and it repeats itself continuously. For any given length, linear density, and tension of the string, there are certain frequencies for which, at, at least one point on the string, the interference is always constructive. When this is the case, the oscillations at that point (or those points) on the string are maximal and the string is said to have *standing waves* in it. Again, standing waves result from the interference of the reflected waves with the transmitted waves and with each other. A point on the string at which the interference is always constructive is called an *antinode*. Any string in which standing waves exist also has at least one point at which the interference is always destructive. Such a point on the string does not move from its equilibrium position. Such a point on the string is called a *node*.

It might seem that it would be a daunting task to determine the frequencies that result in standing waves. Suppose you want to investigate whether a point on a string could be an antinode. Consider an instant in time when a wave crest is at that position. You need to find the conditions that would make it so that in the time it takes for the crest to travel to one fixed end of the string, reflect back as a trough and arrive back at the location in question; a trough, e.g. one that was trailing the original crest, propagates just the right distance so that it arrives at the location in question at the same time. As illustrated in the next chapter, the analysis that yields the frequencies of standing waves is easier than these timing considerations would suggest.

31 Strings, Air Columns

Be careful not to jump to any conclusions about the wavelength of a standing wave. Folks will do a nice job drawing a graph of Displacement vs. Position Along the Medium and then interpret it incorrectly. For instance, look at the diagram on this page. Folks see that a half wavelength fits in the string segment and quickly write the wavelength as $\lambda = \frac{1}{2}L$. But this equation says that a whole wavelength fits in half the length of the string. This is not at all the case. Rather than recognizing that the fraction $\frac{1}{2}$ is relevant and quickly using that fraction in an expression for the wavelength, one needs to be more systematic. First write what you see, in the form of an equation, and then solve that equation for the wavelength. For instance, in the diagram below we see that one half a wavelength λ fits in the length L of the string. Writing this in equation form yields $\frac{1}{2}\lambda = L$. Solving this for λ yields $\lambda = 2L$.

One can determine the wavelengths of standing waves in a straightforward manner and obtain the frequencies from

$$v = \lambda f$$

where the wave speed v is determined by the tension and linear mass density of the string. The method depends on the boundary conditions—the conditions at the ends of the wave medium. (The wave medium is the substance [string, air, water, etc.] through which the wave is traveling. The wave medium is what is “waving.”) Consider the case of waves in a string. A fixed end forces there to be a node at that end because the end of the string cannot move. (A node is a point on the string at which the interference is always destructive, resulting in no oscillations. An antinode is a point at which the interference is always constructive, resulting in maximal oscillations.) A free end forces there to be an antinode at that end because at a free end the wave reflects back on itself without phase reversal (a crest reflects as a crest and a trough reflects as a trough) so at a free end you have one and the same part of the wave traveling in both directions along the string. The wavelength condition for standing waves is that the wave must “fit” in the string segment in a manner consistent with the boundary conditions. For a string of length L fixed at both ends, we can meet the boundary conditions if half a wavelength is equal to the length of the string.

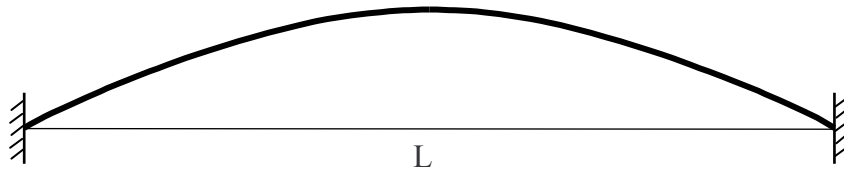

Such a wave “fits” the string in the sense that whenever a zero-displacement part of the wave is aligned with one fixed end of the string another zero-displacement part of the wave is aligned with the other fixed end of the string.

Since half a wavelength fits in the string segment we have:

$$\frac{1}{2}\lambda = L$$

$$\lambda = 2L$$

Given the wave speed v , the frequency can be solved for as follows:

$$v = \lambda f$$

$$f = \frac{v}{\lambda}$$

$$f = \frac{v}{2L}$$

It should be noted that despite the fact that the wave is called a standing wave and the fact that it is typically depicted at an instant in time when an antinode on the string is at its maximum displacement from its equilibrium position, all parts of the string (except the nodes) do oscillate about their equilibrium position.

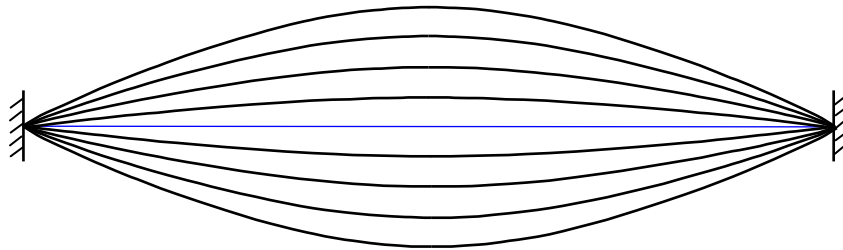

Note that, while the interference at the antinode, the point in the middle of the string in the case at hand, is always as constructive as possible, that does not mean that the string at that point is always at maximum displacement. At times, at that location, there is indeed a crest interfering with a crest, but at other times, there is a zero displacement part of the wave interfering with a zero-displacement part of the wave, at times a trough interfering with a trough, and at times, an intermediate-displacement part of the wave interfering with the same intermediate-displacement part of the wave traveling in the opposite direction. All of this corresponds to the antinode oscillating about its equilibrium position.

The $\lambda = 2L$ wave is not the only wave that will fit in the string. It is, however, the longest wavelength standing wave possible and hence is referred to as *the fundamental*. There is an entire sequence of standing waves. They are named: the fundamental, the first overtone, the second overtone, the third overtone, etc, in order of decreasing wavelength, and hence, increasing frequency.

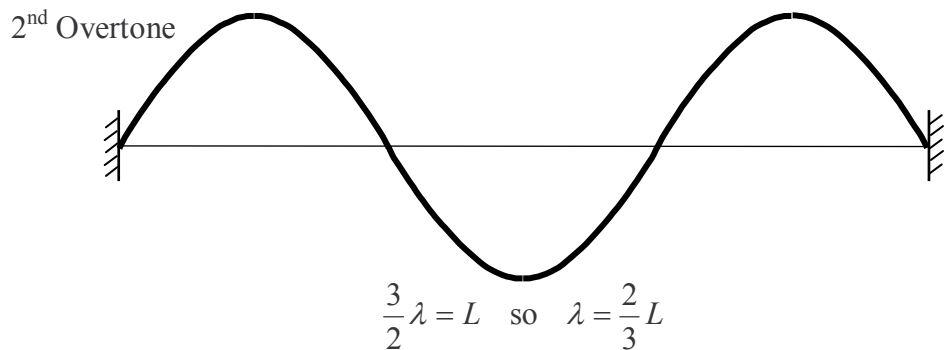
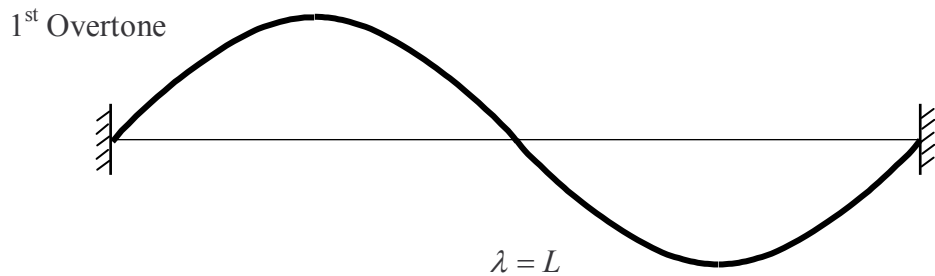
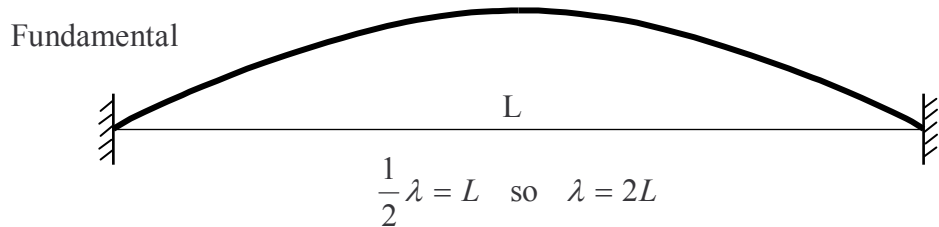

Each successive waveform can be obtained from the preceding one by including one more node.

A wave in the series is said to be a harmonic if its frequency can be expressed as an integer times the fundamental frequency. The value of the integer determines which harmonic (1st, 2nd, 3rd, etc.) the wave is. The frequency of the fundamental wave is, of course, 1 times itself. The number 1 is an integer so the fundamental is a harmonic. It is the 1st harmonic.

Starting with the wavelengths in the series of diagrams above, we have, for the frequencies, using $v = \lambda f$ which can be rearranged to read

$$f = \frac{v}{\lambda}$$

The Fundamental

$$\lambda_{\text{FUND}} = 2L$$

$$f_{\text{FUND}} = \frac{v}{\lambda_{\text{FUND}}}$$

$$f_{\text{FUND}} = \frac{v}{2L}$$

The 1st Overtone

$$\lambda_{\text{1st O.T.}} = L$$

$$f_{\text{1st O.T.}} = \frac{v}{\lambda_{\text{1st O.T.}}}$$

$$f_{\text{1st O.T.}} = \frac{v}{L}$$

The 2nd Overtone

$$\lambda_{\text{2nd O.T.}} = \frac{2}{3}L$$

$$f_{\text{2nd O.T.}} = \frac{v}{\lambda_{\text{2nd O.T.}}}$$

$$f_{\text{2nd O.T.}} = \frac{v}{\frac{2}{3}L}$$

$$f_{\text{2nd O.T.}} = \frac{3}{2} \frac{v}{L}$$

Expressing the frequencies in terms of the fundamental frequency $f_{\text{FUND}} = \frac{v}{2L}$ we have

$$f_{\text{FUND}} = \frac{v}{2L} = 1 \left(\frac{v}{2L} \right) = 1 f_{\text{FUND}}$$

$$f_{1^{\text{st}} \text{ O.T.}} = \frac{v}{L} = 2 \left(\frac{v}{2L} \right) = 2 f_{\text{FUND}}$$

$$f_{2^{\text{nd}} \text{ O.T.}} = \frac{3v}{2L} = 3 \left(\frac{v}{2L} \right) = 3 f_{\text{FUND}}$$

Note that the fundamental is (as always) the 1st harmonic; the 1st overtone is the 2nd harmonic; and the 2nd overtone is the 3rd harmonic. While it is true for the case of a string that is fixed at both ends (the system we have been analyzing), it is *not always* true that the set of all overtones plus fundamental includes all the harmonics. For instance, consider the following example:

Example 31-1

An organ pipe of length L is closed at one end and open at the other. Given that the speed of sound in air is v_s , find the frequencies of the fundamental and the first three overtones.

Solution

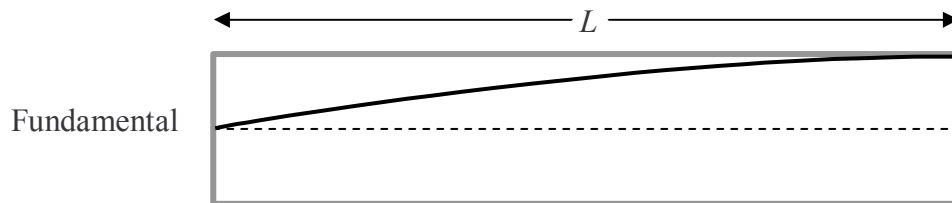

$$\frac{1}{4}\lambda = L \quad \text{so} \quad \lambda = 4L$$

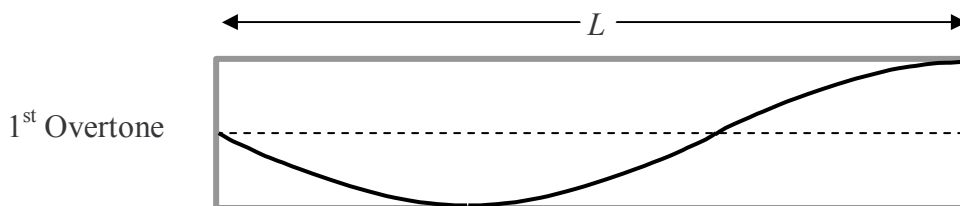

$$\frac{3}{4}\lambda = L \quad \text{so} \quad \lambda = \frac{4}{3}L$$

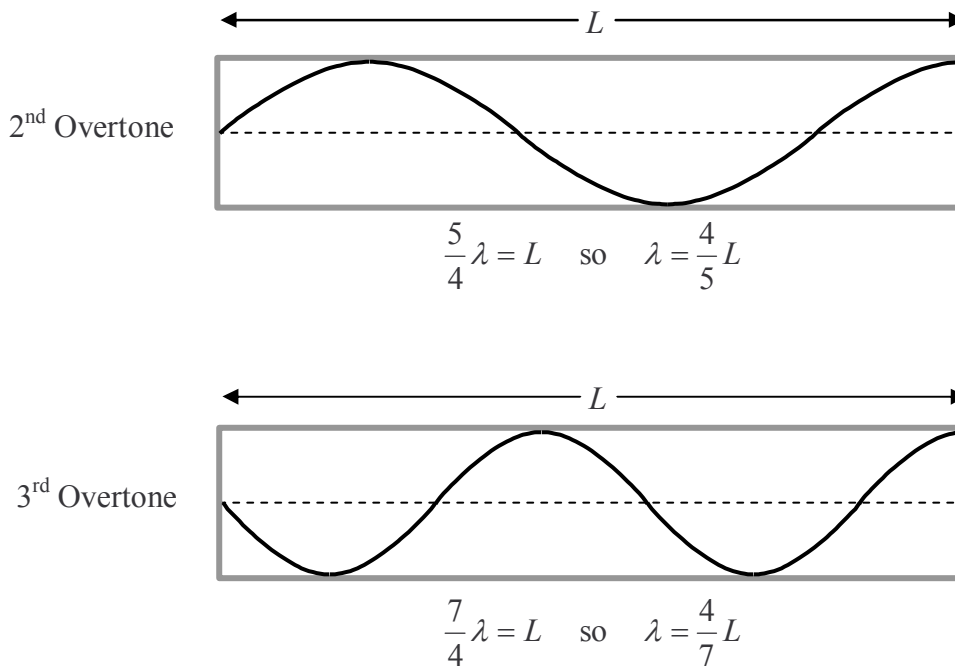

In the preceding sequence of diagrams, a graph of displacement vs. position along the pipe, for an instant in time when the air molecules at an antinode are at their maximum displacement from equilibrium, is a more abstract representation than the corresponding graph for a string. The sound wave in air is a longitudinal wave, so, as the sound waves travel back and forth along the length of the pipe, the air molecules oscillate back and forth (rather than up and down as in the case of the string) about their equilibrium positions. Thus, how high up on the graph a point on the graph is, corresponds to how far to the right (using the viewpoint from which the pipe is depicted in the diagrams) of its equilibrium position the thin layer of air molecules, at the corresponding position in the pipe, is. It is conventional to draw the waveform right inside the outline of the pipe. The boundary conditions are that a closed end is a node and an open end is an antinode.

Starting with the wavelengths in the series of diagrams above, we have, for the frequencies, using $v_s = \lambda f$ which can be rearranged to read

$$f = \frac{v_s}{\lambda}$$

The Fundamental

$$\lambda_{\text{FUND}} = 4L$$

$$f_{\text{FUND}} = \frac{v_s}{\lambda_{\text{FUND}}}$$

$$f_{\text{FUND}} = \frac{v_s}{4L}$$

The 1st Overtone

$$\lambda_{1\text{st O.T.}} = \frac{4}{3}L$$

$$f_{1\text{st O.T.}} = \frac{V_s}{\lambda_{1\text{st O.T.}}}$$

$$f_{1\text{st O.T.}} = \frac{V_s}{\frac{4}{3}L}$$

$$f_{1\text{st O.T.}} = \frac{3}{4} \frac{V_s}{L}$$

The 2nd Overtone

$$\lambda_{2\text{nd O.T.}} = \frac{4}{5}L$$

$$f_{2\text{nd O.T.}} = \frac{V_s}{\lambda_{2\text{nd O.T.}}}$$

$$f_{2\text{nd O.T.}} = \frac{V_s}{\frac{4}{5}L}$$

$$f_{2\text{nd O.T.}} = \frac{5}{4} \frac{V_s}{L}$$

The 3rd Overtone

$$\lambda_{3\text{rd O.T.}} = \frac{4}{7}L$$

$$f_{3\text{rd O.T.}} = \frac{V_s}{\lambda_{3\text{rd O.T.}}}$$

$$f_{3\text{rd O.T.}} = \frac{V_s}{\frac{4}{7}L}$$

$$f_{3\text{rd O.T.}} = \frac{7}{4} \frac{V_s}{L}$$

Expressing the frequencies in terms of the fundamental frequency $f_{\text{FUND}} = \frac{v_s}{4L}$ we have

$$f_{\text{FUND}} = \frac{v_s}{4L} = 1 \left(\frac{v_s}{4L} \right) = 1 f_{\text{FUND}}$$

$$f_{\text{1st O.T.}} = \frac{3 v_s}{4 L} = 3 \left(\frac{v_s}{4L} \right) = 3 f_{\text{FUND}}$$

$$f_{\text{2nd O.T.}} = \frac{5 v_s}{4 L} = 5 \left(\frac{v_s}{4L} \right) = 5 f_{\text{FUND}}$$

$$f_{\text{3rd O.T.}} = \frac{7 v_s}{4 L} = 7 \left(\frac{v_s}{4L} \right) = 7 f_{\text{FUND}}$$

Note that the frequencies of the standing waves are odd integer multiples of the fundamental frequency. That is to say that only odd harmonics, the 1st, 3rd, 5th, etc. occur in the case of a pipe closed at one end and open at the other.

Regarding, Waves, in a Medium that is in Contact with a 2nd Medium

Consider a violin string oscillating at its fundamental frequency, in air. For convenience of discussion, assume the violin to be oriented so that the oscillations are up and down.

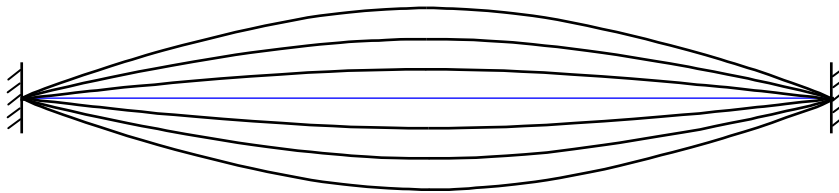

Each time the string goes up it pushes air molecules up. This results in sound waves in air. The violin with the standing wave in it can be considered to be the “something oscillating” that is the cause of the waves in air. Recall that the frequency of the waves is identical to the frequency of the source. Thus, the frequency of the sound waves in air will be identical to the frequency of the waves in the string. In general, the speed of the waves in air is different from the speed of waves in the string. From $v = \lambda f$, this means that the wavelengths will be different as well.

32 Beats, The Doppler Effect

*Some people get mixed up about the Doppler Effect. They think it's about position rather than about velocity. (It is really about velocity.) If a single frequency sound source is coming at you at constant speed, the pitch (frequency) you hear **is** higher than the frequency of the source. How much higher depends on how fast the source is coming at you. Folks make the mistake of thinking that the pitch gets higher as the source approaches the receiver. No. That would be the case if the frequency depended on how close the source was to the receiver. It doesn't. The frequency stays the same. The Doppler Effect is about velocity, **not** position. The whole time the source is moving straight at you, it will sound like it has one single unchanging pitch that is higher than the frequency of the source. **Now duck!** Once the object passes your position and it is heading away from you it will have one single unchanging pitch that is lower than the frequency of the source.*

Beats

Consider two sound sources, in the vicinity of each other, each producing sound waves at its own single frequency. Any point in the air-filled region of space around the sources will receive sound waves from both the sources. The amplitude of the sound at any position in space will be the amplitude of the sum of the displacements of the two waves at that point. This amplitude will vary because the interference will alternate between constructive interference and destructive interference. Suppose the two frequencies do not differ by much. Consider the displacements at a particular point in space. Let's start at an instant when two sound wave crests are arriving at that point, one from each source. At that instant the waves are interfering constructively, resulting in a large total amplitude. If your ear were at that location, you would find the sound relatively loud. Let's mark the passage of time by means of the shorter period, the period of the higher-frequency waves. One period after the instant just discussed, the next crest (call it the second crest) from the higher-frequency source is at the point in question, but the peak of the next crest from the lower-frequency source is not there yet. Rather than a crest interfering with a crest, we have a crest interfering with an intermediate-displacement part of the wave. The interference is still constructive but not to the degree that it was. When the third crest from the higher-frequency source arrives, the corresponding crest from the lower-frequency source is even farther behind. Eventually, a crest from the higher-frequency source is arriving at the point in question at the same time as a trough from the lower-frequency source. At that instant in time, the interference is as destructive as it gets. If your ear were at the point in question, you would find the sound to be inaudible or of very low volume. Then the trough from the lower-frequency source starts "falling behind" until, eventually a crest from the higher-frequency source is interfering with the crest preceding the corresponding crest from the lower-frequency source and the interference is again as constructive as possible.

To a person whose ear is at a location at which waves from both sources exist, the sound gets loud, soft, loud, soft, etc. The frequency with which the loudness pattern repeats itself is called the beat frequency. Experimentally, we can determine the beat frequency by timing how long it takes for the sound to get loud N times and then dividing that time by N (where N is an arbitrary

integer chosen by the experimenter—the bigger the N the more precise the result). This gives the beat period. Taking the reciprocal of the beat period yields the beat frequency.

The beat frequency is to be contrasted with the ordinary frequency of the waves. In sound, we hear the beat frequency as the rate at which the loudness of the sound varies whereas we hear the ordinary frequency of the waves as the pitch of the sound.

Derivation of the Beat Frequency Formula

Consider sound from two different sources impinging on one point, call it point P, in air-occupied space. Assume that one source has a shorter period T_{SHORT} and hence a higher frequency f_{HIGH} than the other (which has period and frequency T_{LONG} and f_{LOW} respectively). The plan here is to express the beat frequency in terms of the frequencies of the sources—we get there by relating the periods to each other. As in our conceptual discussion, let's start at an instant when a crest from each source is at point P. When, after an amount of time T_{SHORT} passes, the next crest from the shorter-period source arrives, the corresponding crest from the longer-period source won't arrive for an amount of time $\Delta T = T_{\text{LONG}} - T_{\text{SHORT}}$. In fact, with the arrival of each successive short-period crest, the corresponding long-period crest is another ΔT behind. Eventually, after some number n of short periods, the long-period crest will arrive a full long period T_{LONG} after the corresponding short-period crest arrives.

$$n \Delta T = T_{\text{LONG}} \quad (32-1)$$

This means that as the short-period crest arrives, the long-period crest that precedes the corresponding long-period crest is arriving. This results in constructive interference (loud sound). The time it takes, starting when the interference is maximally constructive, for the interference to again become maximally constructive is the beat period

$$T_{\text{BEAT}} = n T_{\text{SHORT}} \quad (32-2)$$

Let's use equation 32-1 to eliminate the n in this expression. Solving equation 32-1 for n we find that

$$n = \frac{T_{\text{LONG}}}{\Delta T}$$

Substituting this into equation 32-2 yields

$$T_{\text{BEAT}} = \frac{T_{\text{LONG}}}{\Delta T} T_{\text{SHORT}}$$

ΔT is just $T_{\text{LONG}} - T_{\text{SHORT}}$ so

$$T_{\text{BEAT}} = \frac{T_{\text{LONG}}}{T_{\text{LONG}} - T_{\text{SHORT}}} T_{\text{SHORT}}$$

$$T_{\text{BEAT}} = \frac{T_{\text{LONG}} T_{\text{SHORT}}}{T_{\text{LONG}} - T_{\text{SHORT}}}$$

Dividing top and bottom by the product $T_{\text{LONG}} T_{\text{SHORT}}$ yields

$$T_{\text{BEAT}} = \frac{1}{\frac{1}{T_{\text{SHORT}}} - \frac{1}{T_{\text{LONG}}}}$$

Taking the reciprocal of both sides results in

$$\frac{1}{T_{\text{BEAT}}} = \frac{1}{T_{\text{SHORT}}} - \frac{1}{T_{\text{LONG}}}$$

Now we use the frequency-period relation $f = \frac{1}{T}$ to replace each reciprocal period with its corresponding frequency. This yields:

$$f_{\text{BEAT}} = f_{\text{HIGH}} - f_{\text{LOW}} \quad (32-3)$$

for the beat frequency in terms of the frequencies of the two sources.

The Doppler Effect

Consider a single-frequency sound source and a receiver. The source is something oscillating. It produces sound waves. They travel through air, at speed v , the speed of sound in air, to the receiver and cause some part of the receiver to oscillate. (For instance, if the receiver is your ear, the sound waves cause your eardrum to oscillate.) If the receiver and the source are at rest relative to the air, then the received frequency is the same as the source frequency.

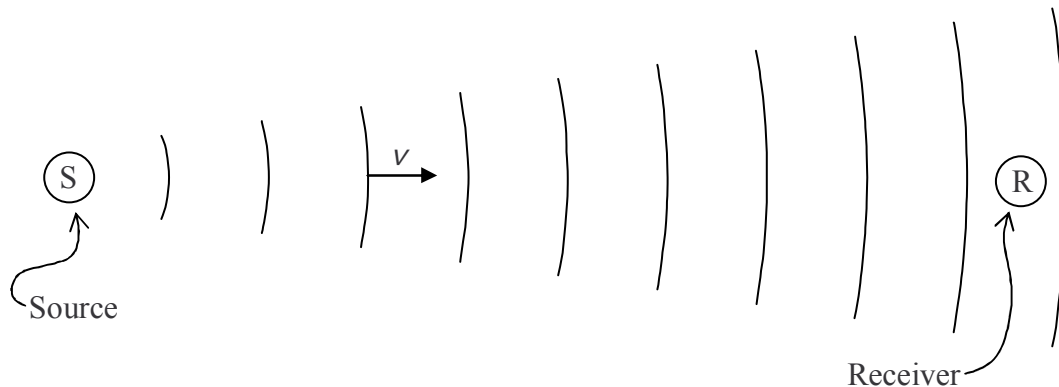

But if the source is moving toward or away from the receiver, and/or the receiver is moving toward or away from the source, the received frequency will be different from the source frequency. Suppose for instance, the receiver is moving toward the source with speed v_R .

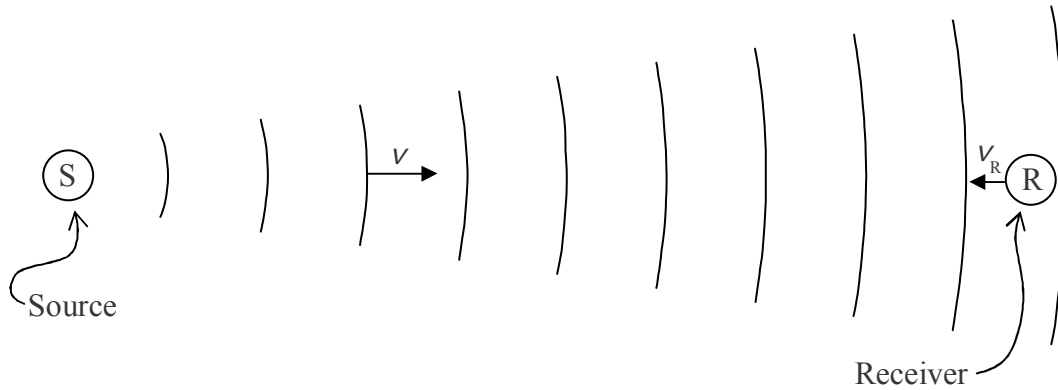

The receiver meets wave crests more frequently than it would if it were still. Starting at an instant when a wavefront is at the receiver, the receiver and the next wavefront are coming together at the rate $v + v_R$ (where v is the speed of sound in air). The distance between the wavefronts is just the wavelength λ which is related to the source frequency f by $v = \lambda f$ meaning that $\lambda = \frac{v}{f}$. From the fact that, in the case of constant velocity, distance is just speed times time, we have:

$$\lambda = (v + v_R) T'$$

$$T' = \frac{\lambda}{v + v_R} \tag{32-4}$$

for the period of the received oscillations. Using $T' = \frac{1}{f'}$ and $\lambda = \frac{v}{f}$ equation 32-4 can be written as:

$$\frac{1}{f'} = \frac{v/f}{v + v_R}$$

$$\frac{1}{f'} = \frac{v}{v + v_R} \frac{1}{f}$$

$$f' = \frac{v + v_R}{v} f \tag{Receiver Approaching Source}$$

This equation states that the received frequency f' is a factor times the source frequency. The expression $v + v_R$ is the speed at which the sound wave in air and the receiver are approaching each other. If the receiver is moving away from the source at speed v_R , the speed at which the

sound waves are “catching up with” the receiver is $v - v_R$ and our expression for the received frequency becomes

$$f' = \frac{v - v_R}{v} f \quad (\text{Receiver Receding from Source})$$

Now consider the case in which the source is moving toward the receiver.

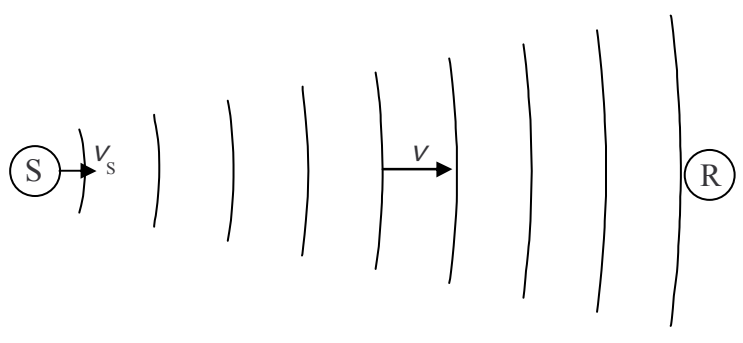

The source produces a crest which moves toward the receiver at the speed of sound. But the source moves along behind that crest so the next crest it produces is closer to the first crest than it would be if the source was at rest. This is true of all the subsequent crests as well. They are all closer together than they would be if the source was at rest. This means that the wavelength of the sound waves traveling in the direction of the source is reduced relative to what the wavelength would be if the source was at rest.

The distance d that the source travels toward the receiver in the time from the emission of one crest to the emission of the next crest, that is in period T of the source oscillations, is

$$d = v_s T$$

where v_s is the speed of the source. The wavelength is what the wavelength would be (λ) if the source was at rest, minus the distance $d = v_s T$ that the source travels in one period

$$\lambda' = \lambda - d$$

$$\lambda' = \lambda - v_s T \quad (32-5)$$

Now we'll use $v = \lambda f$ solved for wavelength $\lambda = \frac{v}{f}$ to eliminate the wavelengths and $f = \frac{1}{T}$

solved for the period $T = \frac{1}{f}$ to eliminate the period. With these substitutions, equation 32-5 becomes

$$\frac{v}{f'} = \frac{v}{f} - v_s \frac{1}{f}$$

$$\frac{v}{f'} = \frac{1}{f}(v - v_s)$$

$$\frac{f'}{v} = f \frac{1}{v - v_s}$$

$$f' = \frac{v}{v - v_s} f \quad (\text{Source Approaching Receiver})$$

If the source is moving away from the receiver, the sign in front of the speed of the source is reversed meaning that

$$f' = \frac{v}{v + v_s} f \quad (\text{Source Receding from Receiver})$$

The four expressions for the received frequency as a function of the source frequency are combined on your formula sheet where they are written as:

$$f' = \frac{v \pm v_R}{v \mp v_s} f \quad (32-6)$$

In solving a Doppler Effect problem, rather than copying this expression directly from your formula sheet, you need to be able to pick out the actual formula that you need. For instance, if the receiver is not moving relative to the air you should omit the $\pm v_R$. If the source is not moving relative to the air, you need to omit the $\mp v_s$.

To get the formula just right you need to recognize that when either the source is moving toward the receiver or the receiver is moving toward the source, the Doppler-shifted received frequency is higher (and you need to recognize that when either is moving away from the other, the Doppler-shifted received frequency is lower). You also need enough mathematical savvy to know which sign to choose to make the received frequency f' come out right.

33 Fluids: Pressure, Density, Archimedes' Principle

One mistake you see in solutions to submerged-object static fluid problems, is the inclusion, in the free body diagram for the problem, in addition to the buoyant force, of a pressure-times-area force typically expressed as $F_p = PA$. This is double counting.

Folks that include such a force, in addition to the buoyant force, don't realize that the buoyant force is the net sum of all the pressure-times-area forces exerted, on the submerged object by the fluid in which it is submerged.

Gases and liquids are fluids. Unlike solids, they flow. A fluid is a liquid or a gas.

Pressure

A fluid exerts pressure on the surface of any substance with which the fluid is in contact. Pressure is force-per-area. In the case of a fluid in contact with a flat surface over which the pressure of the fluid is constant, the magnitude of the force on that surface is the pressure times the area of the surface. Pressure has units of N/m^2 .

Never say that pressure is the amount of force exerted on a certain amount of area. Pressure is not an amount of force. Even in the special case in which the pressure over the "certain amount of area" is constant, the pressure is not the amount of force. In such a case, the pressure is what you have to multiply the area by to determine the amount of force.

The fact that the pressure in a fluid is 5 N/m^2 in no way implies that there is a force of 5 N acting on a square meter of surface (any more than the fact that the speedometer in your car reads 35 mph implies that you are traveling 35 miles or that you have been traveling for an hour). In fact, if you say that the pressure at a particular point underwater in a swimming pool is $15,000 \text{ N/m}^2$ (fifteen thousand newtons per square meter), you are not specifying any area whatsoever. What you are saying is that any infinitesimal surface element that may be exposed to the fluid at that point will experience an infinitesimal force of magnitude dF that is equal to $15,000 \text{ N/m}^2$ times the area dA of the surface. When we specify a pressure, we're talking about a would-be effect on a would-be surface element.

We talk about an infinitesimal area element because it is entirely possible that the pressure varies with position. If the pressure at one point in a liquid is $15,000 \text{ N/m}^2$ it could very well be $16,000 \text{ N/m}^2$ at a point that's less than a millimeter away in one direction and $14,000 \text{ N/m}^2$ at a point that's less than a millimeter away in another direction.

Let's talk about direction. Pressure itself has no direction. But the force that a fluid exerts on a surface element, because of the pressure of the fluid, does have direction. The force is perpendicular to, and toward, the surface. Isn't that interesting? The direction of the force resulting from some pressure (let's call that the pressure-times-area force) on a surface element is determined by the victim (the surface element) rather than the agent (the fluid).

Pressure Dependence on Depth

For a fluid near the surface of the earth, the pressure in the fluid increases with depth. You may have noticed this, if you have ever gone deep under water, because you can feel the effect of the pressure on your ear drums. Before we investigate this phenomenon in depth, I need to point out that in the case of a gas, this pressure dependence on depth is, for many practical purposes, negligible. In discussing a container of a gas for instance, we typically state a single value for the pressure of the gas in the container, neglecting the fact that the pressure is greater at the bottom of the container. We neglect this fact because the difference in the pressure at the bottom and the pressure at the top is so very small compared to the pressure itself at the top. We do this when the pressure difference is too small to be relevant, but it should be noted that even a very small pressure difference can be significant. For instance, a helium-filled balloon, released from rest near the surface of the earth would fall to the ground if it weren't for the fact that the air pressure in the vicinity of the lower part of the balloon is greater (albeit only slightly greater) than the air pressure in the vicinity of the upper part of the balloon.

Let's do a thought experiment. (Einstein was fond of thought experiments. They are also called Gedanken experiments. Gedanken is the German word for thought.) Imagine that we construct a pressure gauge as follows: We cap one end of a piece of thin pipe and put a spring completely inside the pipe with one end in contact with the end cap. Now we put a disk whose diameter is equal to the inside diameter of the pipe, in the pipe and bring it into contact with the other end of the spring. We grease the inside walls of the pipe so that the disk can slide freely along the length of the pipe, but we make the fit exact so that no fluid can get past the disk. Now we drill a hole in the end cap, remove all the air from the region of the pipe between the disk and the end cap, and seal up the hole. The position of the disk in the pipe, relative to its position when the spring is neither stretched nor compressed, is directly proportional to the pressure on the outer surface, the side facing away from the spring, of the disk. We calibrate (mark a scale on) the pressure gauge that we have just manufactured, and use it to investigate the pressure in the water of a swimming pool. First we note that, as soon as we removed the air, the gauge started to indicate a significant pressure (around $1.013 \times 10^5 \text{ N/m}^2$), namely the air pressure in the atmosphere. Now we move the gauge around and watch the gauge reading. Wherever we put the gauge (we define the location of the gauge to be the position of the center point on the outer surface of the disk) on the surface of the water, we get one and the same reading, (the air pressure reading). Next we verify that the pressure reading does indeed increase as we lower the gauge deeper and deeper into the water. Then we find, the point I wrote this paragraph to make, that if we move the gauge around horizontally at one particular depth, the pressure reading does not change. That's the experimental result I want to use in the following development, the experimental fact that the pressure has one and the same value at all points that are at one and the same depth in a fluid.

Here we derive a formula that gives the pressure in an incompressible static fluid as a function of the depth in the fluid. Let's get back into the swimming pool. Now imagine a closed surface enclosing a volume, a region in space, that is full of water. I'm going to call the water in such a volume, "a volume of water," and I'm going to give it another name as well. If it were ice, I would call it a chunk of ice, but since it is liquid water, I'll call it a "slug" of water. We're going

to derive the pressure vs. depth relation by investigating the equilibrium of an “object” which is a slug of water.

Consider a cylindrical slug of water whose top is part of the surface of the swimming pool and whose bottom is at some arbitrary depth h below the surface. I'm going to draw the slug here, isolated from its surroundings. The slug itself is, of course, surrounded by the rest of the water in the pool.

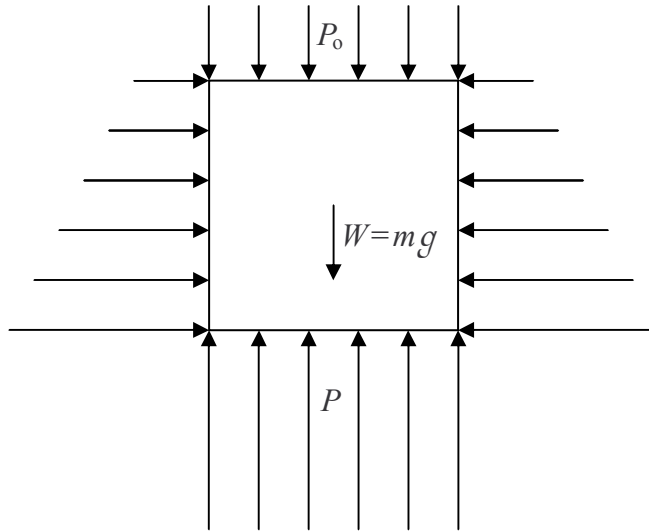

In the diagram, we use arrows to convey the fact that there is pressure-times-area force on every element of the surface of the slug. Now the downward pressure-times-area force on the top of the slug is easy to express in terms of the pressure because the pressure on every infinitesimal area element making up the top of the slug has one and the same value. In terms of the determination of the pressure-times-area, this is the easy case. The magnitude of the force, F_0 , is just the pressure P_0 times the area A of the top of the cylinder.

$$F_0 = P_0 A$$

A similar argument can be made for the bottom of the cylinder. All points on the bottom of the cylinder are at the same depth in the water so all points are at one and the same pressure P . The bottom of the cylinder has the same area A as the top so the magnitude of the upward force F on the bottom of the cylinder is given by

$$F = PA$$

As to the sides, if we divide the sidewalls of the cylinder up into an infinite set of equal-sized infinitesimal area elements, for every sidewall area element, there is a corresponding area element on the opposite side of the cylinder. The pressure is the same on both elements because they are at the same depth. The two forces then have the same magnitude, but because the elements face in opposite directions, the forces have opposite directions. Two opposite but equal

forces add up to zero. In such a manner, all the forces on the sidewall area elements cancel each other out.

Now we are in a position to draw a free body diagram of the cylindrical slug of water.

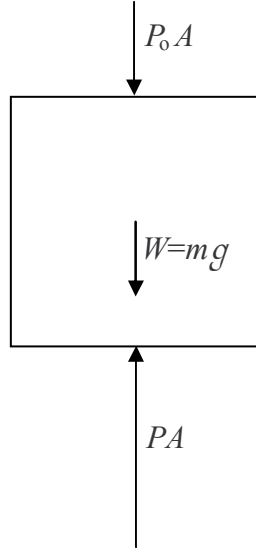

Applying the equilibrium condition

$$\sum F_{\uparrow} = 0$$

yields

$$PA - mg - P_0 A = 0 \quad (33-1)$$

At this point in our derivation of the relation between pressure and depth, the depth does not explicitly appear in the equation. The mass of the slug of water, however, does depend on the length of the slug which is indeed the depth h . First we note that

$$m = \rho V \quad (33-2)$$

where ρ is the density, the mass-per-volume, of the water making up the slug and V is the volume of the slug. The volume of a cylinder is its height times its face area so we can write

$$m = \rho h A$$

Substituting this expression for the mass of the slug into equation 33-1 yields

$$PA - \rho h A g - P_0 A = 0$$

$$P - \rho h g - P_0 = 0$$

$$P = P_0 + \rho g h \quad (33-3)$$

While we have been writing specifically about water, the only thing in the analysis that depends on the identity of the incompressible fluid is the density ρ . Hence, as long as we use the density of the fluid in question, equation 33-3 ($P = P_0 + \rho gh$) applies to any incompressible fluid. It says that the pressure at any depth h is the pressure at the surface plus ρgh .

A few words on the units of pressure are in order. We have stated that the units of pressure are N/m^2 . This combination of units is given a name. It is called the *pascal*, abbreviated Pa.

$$1 \text{ Pa} = 1 \frac{\text{N}}{\text{m}^2}$$

Pressures are often quoted in terms of the non-SI unit of pressure, the *atmosphere*, abbreviated atm and defined such that, on the average, the pressure of the earth's atmosphere at sea level is 1 atm. In terms of the pascal,

$$1 \text{ atm} = 1.013 \times 10^5 \text{ Pa}$$

The big mistake that folks make in applying equation 33-3 ($P = P_0 + \rho gh$) is to ignore the units. They'll use 1 atm for P_0 and without converting that to pascals, they'll add the product ρgh to it. Of course, if one uses SI units for ρ , g , and h , the product ρgh comes out in N/m^2 which is a pascal which is definitely not an atmosphere (but rather, about a hundred-thousandth of an atmosphere). Of course one can't add a value in pascals to a value in atmospheres. The way to go is to convert the value of P_0 that was given to you in units of atmospheres, to pascals, and then add the product ρgh (in SI units) to your result so that your final answer comes out in pascals.

Gauge Pressure

Remember the gauge we constructed for our thought experiment? That part about evacuating the inside of the pipe presents quite the manufacturing challenge. The gauge would become inaccurate as air leaked in by the disk. As regards function, the description is fairly realistic in terms of actual pressure gauges in use, except for the pumping of the air out the pipe. To make it more like an actual gauge that one might purchase, we would have to leave the interior open to the atmosphere. In use then, the gauge reads zero when the pressure on the sensor end is 1 atmosphere, and in general, indicates the amount by which the pressure being measured exceeds atmospheric pressure. This quantity, the amount by which a pressure exceeds atmospheric pressure, is called gauge pressure (since it is the value registered by a typical pressure gauge.) When it needs to be contrasted with gauge pressure, the actual pressure that we

have been discussing up to this point is called *absolute pressure*. The absolute pressure and the gauge pressure are related by:

$$P = P_G + P_O \quad (33-4)$$

where:

P is the absolute pressure,
 P_G is the gauge pressure, and
 P_O is atmospheric pressure.

When you hear a value of pressure (other than the so-called barometric pressure of the earth's atmosphere) in your everyday life, it is typically a gauge pressure (even though one does not use the adjective "gauge" in discussing it.) For instance, if you hear that the recommended tire pressure for your tires is 32 psi (pounds per square inch) what is being quoted is a gauge pressure. Folks that work on ventilation systems often speak of negative air pressure. Again, they are actually talking about gauge pressure, and a negative value of gauge pressure in a ventilation line just means that the absolute pressure is less than atmospheric pressure.

Archimedes' Principle

The net pressure-times-area force on an object submerged in a fluid, the vector sum of the forces on all the infinite number of infinitesimal surface area elements making up the surface of an object, is *upward* because of the fact that pressure increases with depth. The upward pressure-times-area force on the bottom of an object is greater than the downward pressure-times-area force on the top of the object. The result is a net upward force on any object that is either partly or totally submerged in a fluid. The force is called the buoyant force on the object. The agent of the buoyant force is the fluid.

If you take an object in your hand, submerge the object in still water, and release the object from rest, one of three things will happen: The object will experience an upward acceleration and bob to the surface, the object will remain at rest, or the object will experience a downward acceleration and sink. We have emphasized that the buoyant force is always upward. So why on earth would the object ever sink? The reason is, of course, that after you release the object, the buoyant force is not the only force acting on the object. The gravitational force still acts on the object when the object is submerged. Recall that the earth's gravitational field permeates everything. For an object that is touching nothing of substance but the fluid it is in, the free body diagram (without the acceleration vector being included) is always the same (except for the relative lengths of the arrows):

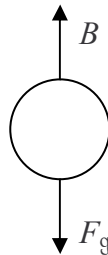

and the whole question as to whether the object (released from rest in the fluid) sinks, stays put, or bobs to the surface, is determined by how the magnitude of the buoyant force compares with

that of the gravitational force. If the buoyant force is greater, the net force is upward and the object bobs toward the surface. If the buoyant force and the gravitational force are equal in magnitude, the object stays put. And if the gravitational force is greater, the object sinks.

So how does one determine how big the buoyant force on an object is? First, the trivial case: If the only forces on the object are the buoyant force and the gravitational force, and the object remains at rest, then the buoyant force must be equal in magnitude to the gravitational force. This is the case for an object such as a boat or a log which is floating on the surface of the fluid it is in.

But suppose the object is not freely floating at rest. Consider an object that is submerged in a fluid. We have no information on the acceleration of the object, but we cannot assume it to be zero. Assume that a person has, while maintaining a firm grasp on the object, submerged the object in fluid, and then, released it from rest. We don't know which way it is going from there, but we can *not* assume that it is going to stay put.

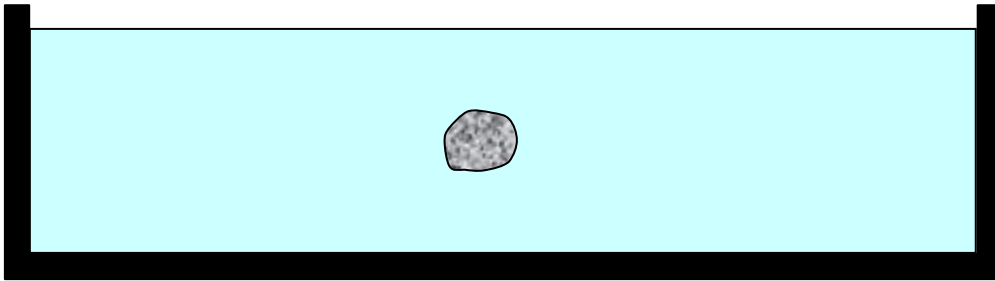

To derive our expression for the buoyant force, we do a little thought experiment. Imagine replacing the object with a slug of fluid (the same kind of fluid as that in which the object is submerged), where the slug of fluid has the exact same size and shape as the object.

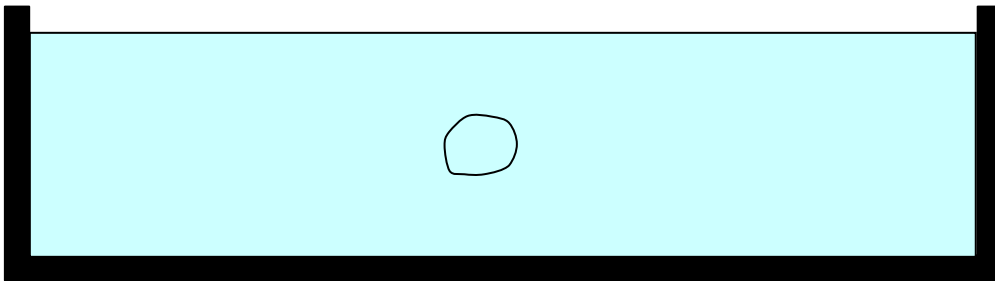

From our experience with still water we know that the slug of fluid would indeed stay put, meaning that *it* is in equilibrium.

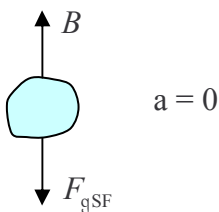

Table of Forces			
<i>Symbol=?</i>	<i>Name</i>	<i>Agent</i>	<i>Victim</i>
B	Buoyant Force	The Surrounding Fluid	The Slug of Fluid
$F_{gSF} = m_{SF}g$	Gravitational Force on the Slug of Fluid	The Earth's Gravitational Field	The Slug of Fluid

Applying the equilibrium equation $\sum F_{\uparrow} = 0$ to the slug of fluid yields:

$$\sum F_{\uparrow} = 0$$

$$B - F_{\text{gSF}} = 0$$

$$B = F_{\text{gSF}}$$

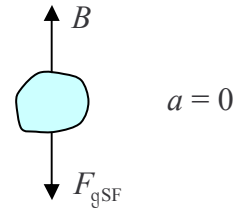

The last equation states that the buoyant force on the slug of fluid is equal to the gravitational force on the slug of fluid. Now get this; this is the crux of the derivation: Because the slug of fluid has the exact same size and shape as the original object, it presents the exact same surface to the surrounding fluid, and hence, the surrounding fluid exerts the same buoyant force on the slug of fluid as it does on the original object. Since the buoyant force on the slug of fluid is equal in magnitude to the gravitational force acting on the slug of fluid, the buoyant force on the original object is equal in magnitude to the gravitational force acting on the slug of fluid. This is Archimedes' principle.

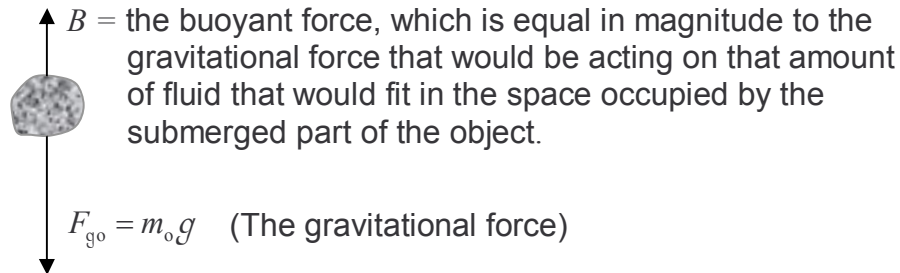

Archimedes' Principle states that: The buoyant force on an object that is either partly or totally submerged in a fluid is upward, and is equal in magnitude to the gravitational force that would be acting on that amount of fluid that would be where the object is if the object wasn't there. For an object that is totally submerged, the *volume* of that amount of fluid that would be where the object is if the object wasn't there is equal to the volume of the object itself. But for an object that is only partly submerged, the volume of that amount of fluid that would be where the object is if the object wasn't there is equal to the (typically unknown) volume of the *submerged part* of the object. However, if the object is freely floating at rest, the equilibrium equation (instead of Archimedes' Principle) can be used to quickly establish that the buoyant force (of a freely floating object such as a boat) is equal in magnitude to the gravitational force acting on the object itself.

34 Pascal's Principle, the Continuity Equation, and Bernoulli's Principle

There are a couple of mistakes that tend to crop up with some regularity in the application of the Bernoulli equation $P + \frac{1}{2}\rho v^2 + \rho gh = \text{constant}$. Firstly, folks tend to forget to create a diagram in order to identify point 1 and point 2 in the diagram so that they can write the Bernoulli equation in its useful form: $P_1 + \frac{1}{2}\rho v_1^2 + \rho gh_1 = P_2 + \frac{1}{2}\rho v_2^2 + \rho gh_2$. Secondly, when both the velocities in Bernoulli's equation are unknown, they forget that there is another equation that relates the velocities, namely, the continuity equation in the form $A_1 v_1 = A_2 v_2$ which states that the flow rate at position 1 is equal to the flow rate at position 2.

Pascal's Principle

Experimentally, we find that if you increase the pressure by some given amount at one location in a fluid, the pressure increases by that same amount everywhere in the fluid. This experimental result is known as Pascal's Principle.

We take advantage of Pascal's principle every time we step on the brakes of our cars and trucks. The brake system is a hydraulic system. The fluid is oil that is called hydraulic fluid. When you depress the brake pedal you increase the pressure everywhere in the fluid in the hydraulic line. At the wheels, the increased pressure acting on pistons attached to the brake pads pushes them against disks or drums connected to the wheels.

Example 34-1

A simple hydraulic lift consists of two pistons, one larger than the other, in cylinders connected by a pipe. The cylinders and pipe are filled with water. In use, a person pushes down upon the smaller piston and the water pushes upward on the larger piston. The diameter of the smaller piston is 2.20 centimeters. The diameter of the larger piston is 21.0 centimeters. On top of the larger piston is a metal support and on top of that is a car. The combined mass of the support-plus-car is 998 kg. Find the force that the person must exert on the smaller piston to raise the car at a constant velocity. Neglect the masses of the pistons.

Solution

We start our solution with a sketch.

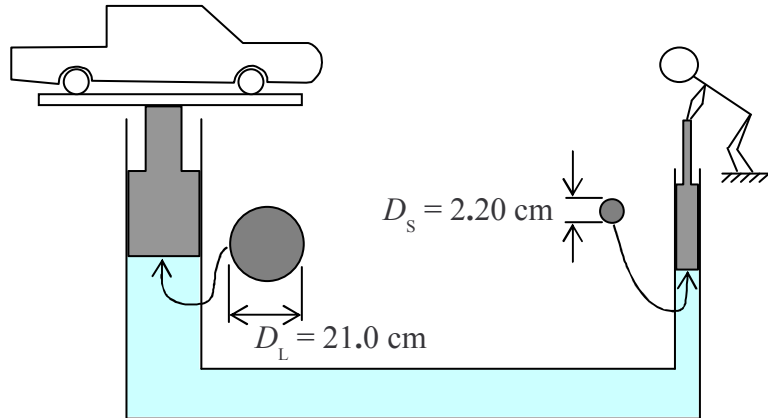

Now, let's find the force R_N exerted on the larger piston by the car support. By Newton's 3rd Law, it is the same as the normal force F_N exerted by the larger piston on the car support. We'll draw and analyze the free body diagram of the car-plus-support to get that.

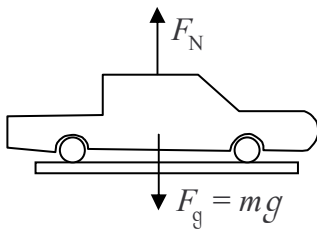

$$\sum F_{\uparrow} = 0$$

$$F_N - mg = 0$$

$$F_N = mg$$

$$F_N = 998 \text{ kg} \left(9.80 \frac{\text{newtons}}{\text{kg}} \right)$$

$$F_N = 9780 \text{ newtons}$$

Table of Forces			
<i>Symbol</i>	<i>Name</i>	<i>Agent</i>	<i>Victim</i>
$F_g = mg$	Gravitational Force on Support-Plus-Car	The Earth's Gravitational Field	The Support-Plus-Car
F_N	Normal Force	The Large Piston	The Support-Plus-Car

Now we analyze the equilibrium of the larger piston to determine what the pressure in the fluid must be in order for the fluid to exert enough force on the piston (with the car-plus-support on it) to keep it moving at constant velocity.

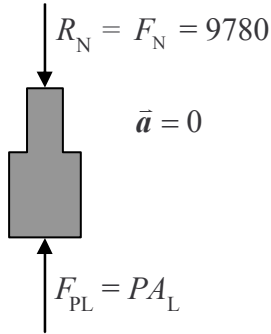

$$\sum F_{\uparrow} = 0$$

$$F_{PL} - R_N = 0$$

$$PA_L - R_N = 0$$

$$P = \frac{R_N}{A_L} \tag{34-1}$$

A_L is the area of the face of the larger piston. We can use the given larger piston diameter $D_L = 0.210$ m to determine the area of the face of the larger piston as follows:

$$A_L = \pi r_L^2 \quad \text{where } r_L = \frac{D_L}{2} \text{ is the radius of the larger piston.}$$

$$A_L = \pi \left(\frac{D_L}{2} \right)^2$$

$$A_L = \pi \left(\frac{0.210 \text{ m}}{2} \right)^2$$

$$A_L = 0.03464 \text{ m}^2$$

Substituting this and the value $R_N = F_N = 9780$ newtons into equation 34-1 above yields

$$P = \frac{9780 \text{ newtons}}{0.03464 \text{ m}^2}$$

$$P = 282333 \frac{\text{N}}{\text{m}^2} \quad \text{(We intentionally keep 3 too many significant figures in this } \textit{intermediate} \text{ result.)}$$

Table of Forces			
Symbol	Name	Agent	Victim
$R_N = F_N = 9780$ newtons	Interaction Partner to Normal Force (see above)	Support (That part, of the hydraulic lift, that the car is on.)	Large Piston
F_{PL}	Pressure-Related Force on Large Piston	The Water	Large Piston

Now we just have to analyze the equilibrium of the smaller piston to determine the force that the person must exert on the smaller piston.

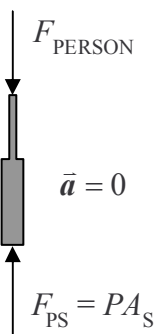

$$\sum F_{\uparrow} = 0$$

$$F_{\text{PS}} - F_{\text{PERSON}} = 0$$

$$PA_{\text{S}} - F_{\text{PERSON}} = 0$$

$$F_{\text{PERSON}} = PA_{\text{S}}$$

The area A_{S} of the face of the smaller piston is just pi times the square of the radius of the smaller piston where the radius is $\frac{D_{\text{S}}}{2}$, half the diameter of the smaller piston. So:

$$F_{\text{PERSON}} = P\pi\left(\frac{D_{\text{S}}}{2}\right)^2$$

$$F_{\text{PERSON}} = 282333 \frac{\text{N}}{\text{m}^2} \pi \left(\frac{0.0220 \text{ m}}{2}\right)^2$$

$$F_{\text{PERSON}} = 107 \text{ N}$$

Fluid in Motion—the Continuity Principle

The Continuity Principle is a fancy name for something that common sense will tell you has to be the case. It is simply a statement of the fact that for any section of a single pipe, filled with an incompressible fluid (an idealization approached by liquids), through which the fluid with which the pipe is filled is flowing, the amount of fluid that goes in one end in any specified amount of time is equal to the amount that comes out the other end in the same amount of time. If we quantify the amount of fluid in terms of the mass, this is a statement of the conservation of mass. Having stipulated that the segment is filled with fluid, the incoming fluid has no room to expand in the segment. Having stipulated that the fluid is incompressible, the molecules making up the fluid cannot be packed closer together; that is, the density of the fluid cannot change. With these stipulations, the total mass of the fluid in the segment of pipe cannot change, so, any time a certain mass of the fluid flows in one end of the segment, the same mass of the fluid must flow out the other end.

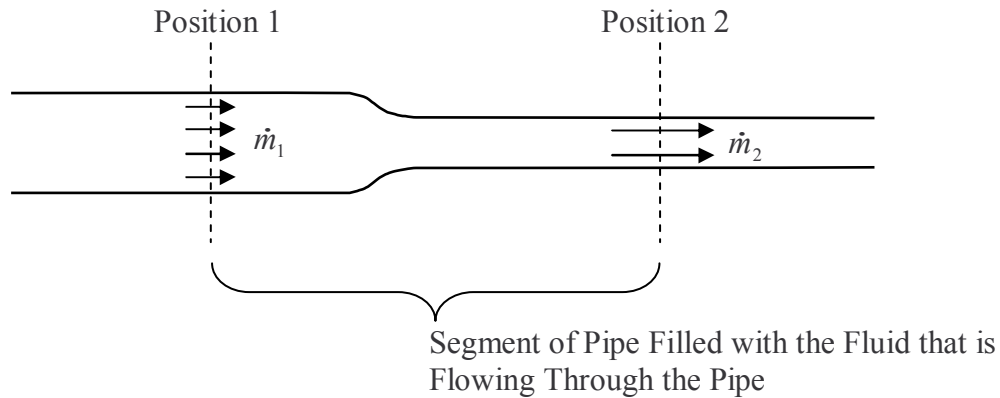

This can only be the case if the mass flow rate, the number of kilograms-per-second passing a given position in the pipe, is the same at both ends of the pipe segment.

$$\dot{m}_1 = \dot{m}_2 \quad (34-2)$$

An interesting consequence of the continuity principle is the fact that, in order for the mass flow rate (the number of kilograms per second passing a given position in the pipe) to be the same in a fat part of the pipe as it is in a skinny part of the pipe, the velocity of the fluid (i.e. the velocity of the molecules of the fluid) must be greater in the skinny part of the pipe. Let's see why this is the case.

Here, we again depict a pipe in which an incompressible fluid is flowing.

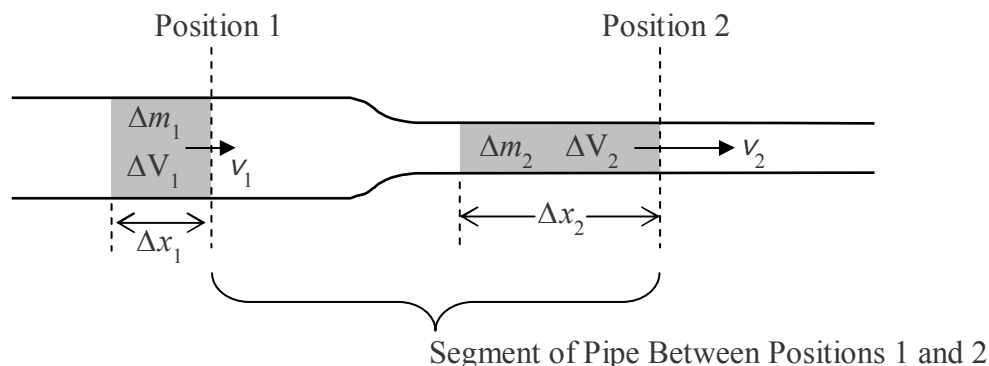

Keeping in mind that the entire pipe is filled with the fluid, the shaded region on the left represents the fluid that will flow past position 1 in time Δt and the shaded region on the right represents the fluid that will flow past position 2 in the same time Δt . In both cases, in order for the entire slug of fluid to cross the relevant position line, the slug must travel a distance equal to its length. Now the slug labeled Δm_2 has to be longer than the slug labeled Δm_1 since the pipe is skinnier at position 2 and by the continuity equation $\Delta m_1 = \Delta m_2$ (the amount of fluid that flows into the segment of the pipe between position 1 and position 2 is equal to the amount of fluid that flows out of it). So, if the slug at position 2 is longer and it has to travel past the position line in the same amount of time as it takes for the slug at position 1 to travel past its position line, the fluid velocity at position 2 must be greater. The fluid velocity is greater at a skinnier position in the pipe.

Let's get a quantitative relation between the velocity at position 1 and the velocity at position 2. Starting with

$$\Delta m_1 = \Delta m_2$$

we use the definition of density to replace each mass with the density of the fluid times the relevant volume:

$$\rho \Delta V_1 = \rho \Delta V_2$$

Dividing both sides by the density tells us something you already know:

$$\Delta V_1 = \Delta V_2$$

As an aside, we note that if you divide both sides by Δt and take the limit as Δt goes to zero, we have $\dot{V}_1 = \dot{V}_2$ which is an expression of the continuity principle in terms of volume flow rate. The volume flow rate is typically referred to simply as the *flow rate*.

While we use the SI units $\frac{\text{m}^3}{\text{s}}$ for flow rate, the reader may be more familiar with flow rate expressed in units of gallons per minute.

Now back to our goal of finding a mathematical relation between the velocities of the fluid at the two positions in the pipe. Here we copy the diagram of the pipe and add, to the copy, a depiction of the face of slug 1 of area A_1 and the face of slug 2 of area A_2 .

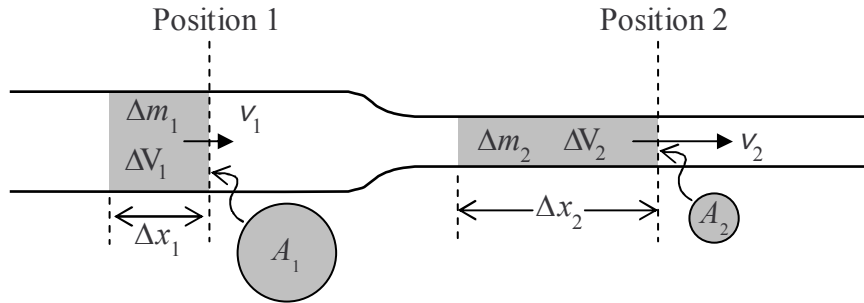

We left off with the fact that $\Delta V_1 = \Delta V_2$. Each volume can be replaced with the area of the face of the corresponding slug times the length of that slug. So,

$$A_1 \Delta x_1 = A_2 \Delta x_2$$

Recall that Δx_1 is not only the length of slug 1, it is also how far slug 1 must travel in order for the entire slug of fluid to get past the position 1 line. The same is true for slug 2 and position 2. Dividing both sides by the one time interval Δt yields:

$$A_1 \frac{\Delta x_1}{\Delta t} = A_2 \frac{\Delta x_2}{\Delta t}$$

Taking the limit as Δt goes to zero results in:

$$A_1 v_1 = A_2 v_2 \quad (34-3)$$

This is the relation, between the velocities, that we have been looking for. It applies to any pair of positions in a pipe completely filled with an incompressible fluid. It can be written as

$$Av = \text{constant} \quad (34-4)$$

which means that the product of the cross-sectional area of the pipe and the velocity of the fluid at that cross section is the same for every position along the fluid-filled pipe. To take advantage of this fact, one typically writes, in equation form, that the product Av at one location is equal to the same product at another location. In other words, one writes equation 34-3.

Note that the expression Av , the product of the cross-sectional area of the pipe, at a particular position, and the velocity of the fluid at that same position, having been derived by dividing an expression for the volume of fluid ΔV that would flow past a given position of the pipe in time Δt , by Δt , and taking the limit as Δt goes to zero, is none other than the *flow rate* (the volume flow rate) discussed in the aside above.

$$\text{Flow Rate} = Av$$

Further note that if we multiply the flow rate by the density of the fluid, we get the mass flow rate.

$$\dot{m} = \rho Av \quad (34-5)$$

Fluid in Motion—Bernoulli's Principle

The derivation of Bernoulli's Equation represents an elegant application of the Work-Energy Theorem. Here we discuss the conditions under which Bernoulli's Equation applies and then simply state and discuss the result.

Bernoulli's Equation applies to a fluid flowing through a full pipe. The degree to which Bernoulli's Equation is accurate depends on the degree to which the following conditions are met:

- 1) The fluid must be experiencing steady state flow. This means that the flow rate at all positions in the pipe is not changing with time.
- 2) The fluid must be experiencing streamline flow. Pick any point in the fluid. The infinitesimal fluid element at that point, at an instant in time, traveled along a certain path to arrive at that point in the fluid. In the case of streamline flow, every infinitesimal element of fluid that ever finds itself at that same point traveled the same path. (Streamline flow is the opposite of turbulent flow.)
- 3) The fluid must be non-viscous. This means that the fluid has no tendency to "stick to" either the sides of the pipe or to itself. (Molasses has high viscosity. Alcohol has low viscosity.)

Consider a pipe full of a fluid that is flowing through the pipe. In the most general case, the cross-sectional area of the pipe is not the same at all positions along the pipe and different parts of the pipe are at different elevations relative to an arbitrary, but fixed, reference level.

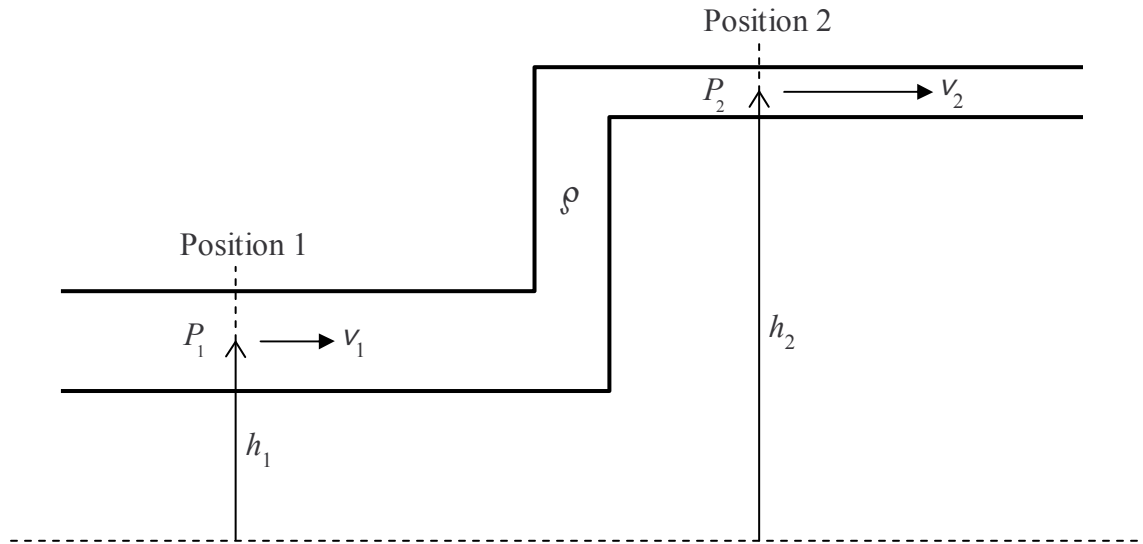

Pick any two positions along the pipe, e.g. positions 1 and 2 in the diagram above. (You already know that, in accord with the continuity principle, $A_1v_1 = A_2v_2$.) Consider the following unnamed sum of terms:

$$P + \frac{1}{2}\rho v^2 + \rho gh$$

where, at the position under consideration:

P is the pressure of the fluid,

ρ (the Greek letter rho) is the density of the fluid,

v is the magnitude of the velocity of the fluid,

$g = 9.80 \frac{\text{N}}{\text{kg}}$ is the near-surface magnitude of the earth's gravitational field, and

h is the elevation, relative to a fixed reference level, of the position in the pipe.

The Bernoulli Principle states that this unnamed sum of terms has the same value at each and every position along the pipe. Bernoulli's equation is typically written:

$$P + \frac{1}{2}\rho v^2 + \rho gh = \text{constant} \quad (34-6)$$

but to use it, you have to pick two positions along the pipe and write an equation stating that the

value of the unnamed sum of terms is the same at one of the positions as it is at the other.

$$P_1 + \frac{1}{2}\rho v_1^2 + \rho g h_1 = P_2 + \frac{1}{2}\rho v_2^2 + \rho g h_2 \quad (34-7)$$

A particularly interesting characteristic of fluids is incorporated in this equation. Suppose positions 1 and 2 are at one and the same elevation as depicted in the following diagram:

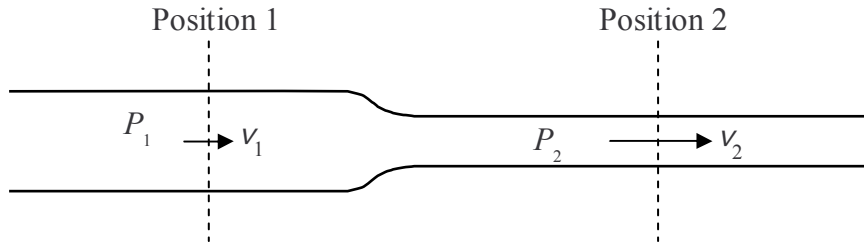

Then $h_1 = h_2$ in equation 34-7 and equation 34-7 becomes:

$$P_1 + \frac{1}{2}\rho v_1^2 = P_2 + \frac{1}{2}\rho v_2^2$$

Check it out. If $v_2 > v_1$ then P_2 must be less than P_1 in order for the equality to hold. This equation is saying that, where the velocity of the fluid is high, the pressure is low.

35 Temperature, Internal Energy, Heat, and Specific Heat Capacity

As you know, temperature is a measure of how hot something is. Rub two sticks together and you will notice that the temperature of each increases. You did work on the sticks and their temperature increased. Doing work is transferring energy. So you transferred energy to the sticks and their temperature increased. This means that an increase in the temperature of a system is an indication of an increase in the internal energy (a.k.a. thermal energy) of the system. (In this context the word system is thermodynamics jargon for the generalization of the word object. Indeed an object, say an iron ball, could be a system. A system is just the subject of our investigations or considerations. A system can be as simple as a sample of one kind of gas or a chunk of one kind of metal, or it can be more complicated as in the case of a can plus some water in the can plus a thermometer in the water plus a lid on the can. For the case at hand, the system is the two sticks.) The internal energy of a system is energy associated with the motion of molecules, atoms, and the particles making up atoms relative to the center of mass of the system, and the potential energy corresponding to the positions and velocities of the aforementioned submicroscopic constituents of the system relative to each other. As usual with energy accounting, the absolute zero of energy in the case of internal energy doesn't matter—only changes in internal energy have any relevance. As such, you or the publisher of a table of internal energy values (for a given substance, publishers actually list the internal energy per mass or the internal energy per mole of the substance under specified conditions rather than the internal energy of a sample of such a substance), are free to choose the zero of internal energy for a given system. In making any predictions regarding a physical process involving that system, as long as you stick with the same zero of internal energy throughout your analysis, the measurable results of your prediction or explanation will not depend on your choice of the zero of internal energy.

Another way of increasing the temperature of a pair of sticks is to bring them into contact with something hotter than the sticks are. When you do that, the temperature of the sticks automatically increases—you don't have to do any work on them. Again, the increase in the temperature of either stick indicates an increase in the internal energy of that stick. Where did that energy come from? It must have come from the hotter object. You may also notice that the hotter object's temperature decreased when you brought it into contact with the sticks. The decrease in temperature of the hotter object is an indication that the amount of internal energy in the hotter object decreased. You brought the hotter object in contact with the sticks and energy was automatically transferred from the hotter object to the sticks. The energy transfer in this case is referred to as the flow of heat. Heat is energy that is automatically transferred from a hotter object to a cooler object when you bring the two objects in contact with each other. Heat is not something that a system has but rather energy that is transferred or is being transferred. Once it gets to the system to which it is transferred we call it internal energy. The idea is to distinguish between what is being done to a system, "Work is done on the system and/or heat is caused to flow into it", with how the system changes as a result of what was done to it, "The internal energy of the system increases."

The fact that an increase in the temperature of an object is an indication of energy transferred to that object might suggest that anytime you transfer energy to an object its temperature increases. But this is not the case. Try putting a hot spoon in a glass of ice water. (Here we consider a case

for which there is enough ice so that not all of the ice melts.) The spoon gets as cold as the ice water and some of the ice melts, but the temperature of the ice water remains the same ($0\text{ }^{\circ}\text{C}$). The cooling of the spoon indicates that energy was transferred from it, and since the spoon was in contact with the ice water the energy must have been transferred to the ice water. Indeed the ice does undergo an observable change; some of it melts. The presence of more liquid water and less ice is an indication that there is more energy in the ice water. Again there has been a transfer of energy from the spoon to the ice water. This transfer is an automatic flow of heat that takes place when the two systems are brought into contact with one another. Evidently, heat flow does not always result in a temperature increase.

Experiment shows that when a higher temperature object is in contact with a lower temperature object, heat is flowing from the higher temperature object to the lower temperature object. The flow of heat persists until the two objects are at one and the same temperature. We define the average translational kinetic energy of a molecule of a system as the sum of the translational kinetic energies of all the molecules making up the system divided by the total number of molecules. When two simple ideal gas systems, each involving a multitude of single atom molecules interacting via elastic collisions, are brought together, we find that heat flows from the system in which the average translational kinetic energy per molecule is greater to the system in which the average translational kinetic energy per molecule is lesser. This means the former system is at a higher temperature. That is to say that the higher the translational kinetic energy, on the average, of the particles making up the system, the higher the temperature. This is true for many systems.

Solids consist of atoms that are bound to neighboring atoms such that molecules tend to be held in their position, relative to the bulk of the solid, by electrostatic forces. A pair of molecules that are bound to each other has a lower amount of internal potential energy relative to the same pair of molecules when they are not bound together because we have to add energy to the bound pair at rest to yield the free pair at rest. In the case of ice water, the transfer of energy into the ice water results in the breaking of bonds between water molecules, which we see as the melting of the ice. As such, the transfer of energy into the ice water results in an increase in the internal potential energy of the system.

The two different kinds of internal energy that we have discussed are internal potential energy and internal kinetic energy. When there is a net transfer of energy into a system, and the macroscopic mechanical energy of the system doesn't change (e.g. for the case of an object near the surface of the earth, the speed of object as a whole does not increase, and the elevation of the object does not increase), the internal energy (the internal kinetic energy, the internal potential energy, or both) of the system increases. In some, but not all, cases, the increase in the internal energy is accompanied by an increase in the temperature of the system. If the temperature doesn't increase, then we are probably dealing with a case in which it is the internal *potential* energy of the system that increases.

Heat Capacity and Specific Heat Capacity

Let's focus our attention on cases in which heat flow into a sample of matter is accompanied by an increase in the temperature of the sample. For many substances, over certain temperature ranges, the temperature change is (at least approximately) proportional to the amount of heat that flows into the substance.

$$\Delta T \propto Q$$

Traditionally, the constant of proportionality is written as $\frac{1}{C}$ so that

$$\Delta T = \frac{1}{C} Q$$

where the upper case C is the heat capacity. This equation is more commonly written as

$$Q = C \Delta T \quad (35-1)$$

which states that the amount of heat that must flow into a system to change the temperature of that system by ΔT is the heat capacity C times the desired temperature change ΔT . Thus the heat capacity C is the "heat-per-temperature-change." Its reciprocal is a measure of a system's temperature sensitivity to heat flow.

Let's focus our attention on the simplest kind of system, a sample of one kind of matter, such as a certain amount of water. The amount of heat that is required to change the temperature of the sample by a certain amount is directly proportional to the mass of the single substance; e.g., if you double the mass of the sample it will take twice as much heat to raise its temperature by, for instance, 1 $^{\circ}\text{C}$. Mathematically, we can write this fact as

$$C \propto m$$

It is traditional to use a lower case c for the constant of proportionality. Then

$$C = cm$$

where the constant of proportionality c is the heat-capacity-per-mass of the substance in question. The heat-capacity-per-mass c is referred to as the mass specific heat capacity or simply the *specific heat capacity* of the substance in question. (In this context, the adjective specific means "per amount." Because the amount can be specified in more than one way we have the expression "mass specific" meaning "per amount of mass" and the expression "molar specific" meaning "per number of moles." Here, since we are only dealing with mass specific heat, we can omit the word "mass" without generating confusion.) The specific heat capacity c has a different value for each different kind of substance in the universe. (Okay, there might be some coincidental duplication but you get the idea.) In terms of the mass specific heat capacity,

equation 35-1 ($Q = C \Delta T$), for the case of a system consisting only of a sample of a single substance, can be written as

$$Q = mc\Delta T \quad (35-2)$$

The specific heat capacity c is a property of the kind of matter of which a substance consists. As such, the values of specific heat for various substances can be tabulated.

Substance	Specific Heat Capacity*
	$\left[\frac{\text{J}}{\text{kg} \cdot \text{C}^\circ} \right]$
Ice (solid water)	2090
Liquid Water	4186
Water Vapor (gas)	2000
Solid Copper	387
Solid Aluminum	902
Solid Iron	448

*The specific heat capacity of a substance varies with temperature and pressure. The values given correspond to atmospheric pressure. Use of these representative constant values for cases involving atmospheric pressure and temperature ranges between -100°C and $+600^\circ\text{C}$, as applicable for the phase of the material, can be expected to yield reasonable results but if precision is required, or information on how reasonable your results are is needed, you should consult a thermodynamics textbook and thermodynamics tables and carry out a more sophisticated analysis.

Note how many more Joules of energy are needed to raise the temperature of 1 kg of liquid water 1°C than are required to raise the temperature of 1 kg of a metal 1°C .

Temperature

Despite the fact that you are quite familiar with it, some more discussion of temperature is in order. Whenever you measure something, you are really just comparing that something with an arbitrarily-established standard. For instance, when you measure the length of a table with a meter stick, you are comparing the length of the table with the modern day equivalent of what was historically established as one ten-thousandth of the distance from the earth's north pole to the equator. In the case of temperature, a standard, now called the "degree Celsius" was established as follows: At 1 atmosphere of pressure, the temperature at which water freezes was defined to be 0°C and the temperature at which water boils was defined to be 100°C . Then a substance with a temperature-dependent measurable characteristic, such as the length of a column of liquid mercury, was used to interpolate and extrapolate the temperature range. (Mark the position of the end of the column of mercury on the tube containing that mercury when it is at the temperature of freezing water and again when it is at the temperature of boiling water. Divide the interval between the two marks into a hundred parts. Use the same length of each of those parts to extend the scale in both directions and call it a temperature scale.)

Note the arbitrary manner in which the zero of the Celsius scale has been established. The choice of zero is irrelevant for our purposes since equations 35-1 ($Q = C \Delta T$) and 35-2

($Q = mc\Delta T$) relate temperature *change*, rather than temperature itself, to the amount of heat flow. An absolute temperature scale has been established for the SI system of units. The zero of temperature on this scale is set at the greatest possible temperature such that it is theoretically impossible for the temperature of any system in equilibrium to be as low as the zero of the Kelvin scale. The unit of temperature on the Kelvin scale is the kelvin, abbreviated K. Note the absence of the degree symbol in the unit. The Kelvin scale is similar to the Celsius scale in that a change in temperature of, say, 1 K, is equivalent to a change in temperature of 1 C°. (Note regarding units notation: The units °C are used for a *temperature* on the Celsius scale, but the units C° are used for a *temperature change* on the Celsius scale.)

On the Kelvin scale, at a pressure of one atmosphere, water freezes at 273.15 K. So, a temperature in kelvin is related to a temperature in °C by

$$\text{Temperature in K} = (\text{Temperature in } ^\circ\text{C}) \cdot \left(\frac{1\text{K}}{^\circ\text{C}}\right) + 273.15 \text{ K}$$

36 Heat: Phase Changes

There is a tendency to believe that any time heat is flowing into ice, the ice is melting. NOT SO. When heat is flowing into ice, the ice will be melting only if the ice is already at the melting temperature. When heat is flowing into the ice that is below the melting temperature, the temperature of the ice is increasing.

As mentioned in the preceding chapter, there are times when you bring a hot object into contact with a cooler sample, that heat flows from the hot object to the cooler sample, but the temperature of the cooler sample does *not* increase, even though no heat flows out of the cooler sample (e.g. into an even colder object). This occurs when the cooler sample undergoes a phase change. For instance, if the cooler sample happens to be H₂O ice or H₂O ice plus liquid water, at 0°C and atmospheric pressure, when heat is flowing into the sample, the ice is melting with no increase in temperature. This will continue until all the ice is melted (assuming enough heat flows into the sample to melt all the ice). Then, after the last bit of ice melts at 0°C, if heat continues to flow into the sample, the temperature of the sample will be increasing¹.

Lets review the question about how it can be that heat flows into the cooler sample without causing the cooler sample to warm up. Energy flows from the hotter object to the cooler sample, but the internal kinetic energy of the cooler sample does not increase. Again, how can that be? What happens is that the energy flow into the cooler sample is accompanied by an increase in the internal *potential* energy of the sample. It is associated with the breaking of electrostatic bonds between molecules where the negative part of one molecule is bonded to the positive part of another. The separating of the molecules corresponds to an increase in the potential energy of the system. This is similar to a book resting on a table. It is gravitationally bound to the earth. If you lift the book and put it on a shelf that is higher than the tabletop, you have added some energy to the earth/book system, but you have increased the potential energy with *no* net increase in the kinetic energy. In the case of melting ice, heat flow into the sample manifests itself as an increase in the potential energy of the molecules without an increase in the *kinetic* energy of the molecules (which would be accompanied by a temperature increase).

The amount of heat that must flow into a single-substance solid sample that is already at its melting temperature in order to melt the whole sample depends on a property of the substance of which the sample consists, and on the mass of the substance. The relevant substance property is called the latent heat of melting. The latent heat of melting is the heat-per-mass needed to melt the substance at the melting temperature. Note that, despite the name, the latent heat is not an amount of heat but rather a ratio of heat to mass. The symbol used to represent latent heat in general is L , and we use the subscript m for melting. In terms of the latent heat of melting, the amount of heat, Q , that must flow into a sample of a single-substance solid that is at the melting temperature, in order to melt the entire sample is given by:

¹ In this discussion, we are treating the sample as if it had one well-defined temperature. This is an approximation. When the sample is in contact with a hotter object so that heat is flowing from the hotter object to the sample, the part of the sample in direct contact with and in the near vicinity of the hotter object will be at a higher temperature than other parts of the sample. The hotter the object, the greater the variation in the temperature of the local bit of the sample with distance from the object. We neglect this temperature variation so our discussion is only appropriate when the temperature variation is small.

$$Q = mL_m$$

Note the absence of a ΔT in the expression $Q = mL_m$. There is no ΔT in the expression because there is no temperature change in the process. The whole phase change takes place at one temperature.

So far, we have talked about the case of a solid sample, at the melting temperature, which is in contact with a hotter object. Heat flows into the sample, melting it. Now consider a sample of the same substance in *liquid* form at the *same* temperature but in contact with a *colder* object. In this case, heat will flow *from* the sample to the colder object. This heat loss from the sample does not result in a decrease in the temperature. Rather, it results in a phase change of the substance of which the sample consists, from liquid to solid. This phase change is called freezing. It also goes by the name of solidification. The temperature at which freezing takes place is called the freezing temperature, but it is important to remember that the freezing temperature has the same value as the melting temperature. The heat-per-mass that must flow out of the substance to freeze it (assuming the substance to be at the freezing temperature already) is called the latent heat of fusion, or L_f . The latent heat of fusion for a given substance has the same value as the latent heat of melting for that substance:

$$L_f = L_m$$

The amount of heat that must flow out of a sample of mass m in order to convert the entire sample from liquid to solid is given by:

$$Q = mL_f$$

Again, there is no temperature change.

The other two phase changes we need to consider are vaporization and condensation. Vaporization is also known as boiling. It is the phase change in which liquid turns into gas. It too (as in the case of freezing and melting), occurs at a single temperature, but for a given substance, the boiling temperature is higher than the freezing temperature. The heat-per-mass that must flow into a liquid to convert it to gas is called the latent heat of vaporization L_v . The heat that must flow *into* mass m of a liquid that is already at its boiling temperature (a.k.a. its vaporization temperature) to convert it entirely into gas is given by:

$$Q = mL_v$$

Condensation is the phase change in which gas turns into liquid. In order for condensation to occur, the gas must be at the condensation temperature, the same temperature as the boiling temperature (a.k.a. the vaporization temperature). Furthermore, heat must flow *out* of the gas, as it does when the gas is in contact with a *colder* object. Condensation takes place at a fixed temperature known as the condensation temperature. (The melting temperature, the freezing temperature, the boiling temperature, and the condensation temperature are also referred to as the melting point, the freezing point, the boiling point, and the condensation point, respectively.) The heat-per-mass that must be extracted from a particular kind of gas that is already at the

condensation temperature, to convert that gas to liquid at the same temperature, is called the latent heat of condensation L_c . For a given substance, the latent heat of condensation has the same value as the latent heat of vaporization. For a sample of mass m of a gas at its condensation temperature, the amount of heat that must flow *out* of the sample to convert the entire sample to liquid is given by:

$$Q = mL_c$$

It is important to note that the actual values of the freezing temperature, the boiling temperature, the latent heat of melting, and the latent heat of vaporization are different for different substances. For *water* we have:

Phase Change	Temperature	Latent Heat
Melting Freezing	0°C	0.334 $\frac{\text{MJ}}{\text{kg}}$
Boiling or Vaporization Condensation	100°C	2.26 $\frac{\text{MJ}}{\text{kg}}$

Example 36-1

How much heat does it take to convert 444 grams of H_2O ice at -9.0°C to steam (H_2O gas) at 128.0°C ?

Discussion of Solution

Rather than solve this one for you, we simply explain how to solve it.

To convert the ice at -9.0°C to steam at 128.0°C , we first have to cause enough heat to flow into the ice to warm it up to the melting temperature, 0°C . This step is a specific heat capacity problem. We use

$$Q_1 = mc_{\text{ice}} \Delta T$$

where ΔT is $[0^\circ\text{C} - (-9.0^\circ\text{C})] = 9.0^\circ\text{C}$.

Now that we have the ice at the melting temperature, we have to add enough heat to melt it. This step is a latent heat problem.

$$Q_2 = mL_m$$

After $Q_1 + Q_2$ flows into the H_2O , we have liquid water at 0°C . Next, we have to find

how much heat must flow into the liquid water to warm it up to the boiling point, 100°C .

$$Q_3 = mc_{\text{liquid water}} \Delta T'$$

where $\Delta T' = (100^{\circ}\text{C} - 0^{\circ}\text{C}) = 100^{\circ}\text{C}$.

After $Q_1 + Q_2 + Q_3$ flows into the H_2O , we have liquid water at 100°C . Next, we have to find how much heat must flow into the liquid water at 100°C to convert it to steam at 100°C .

$$Q_4 = mL_v$$

After $Q_1 + Q_2 + Q_3 + Q_4$ flows into the H_2O , we have water vapor (gas) at 100°C . Now, all we need to do is to find out how much heat must flow into the water gas at 100°C to warm it up to 128°C .

$$Q_5 = mc_{\text{steam}} \Delta T''$$

where $\Delta T'' = 128^{\circ}\text{C} - 100^{\circ}\text{C} = 28^{\circ}\text{C}$.

So the amount of heat that must flow into the sample of solid ice at -9.0°C in order for sample to become steam at 128°C (the answer to the question) is:

$$Q_{\text{total}} = Q_1 + Q_2 + Q_3 + Q_4 + Q_5$$

37 The First Law of Thermodynamics

We use the symbol U to represent internal energy. That is the same symbol that we used to represent the mechanical potential energy of an object. Do not confuse the two different quantities with each other. In problems, questions, and discussion, the context will tell you whether the U represents internal energy or it represents mechanical potential energy.

We end this physics textbook as we began the *physics* part of it (Chapter 1 was a *mathematics* review), with a discussion of conservation of energy. Back in Chapter 2, the focus was on the conservation of mechanical energy; here we focus our attention on thermal energy.

In the case of a deformable system, it is possible to do some net work on the system without causing its mechanical kinetic energy $\frac{1}{2}mv^2 + \frac{1}{2}I\omega^2$ to change (where m is the mass of the system, v is the speed of the center of mass of the system, I is the moment of inertia of the system, and ω is the magnitude of the angular velocity of the system). Examples of such work would be: the bending of a coat hanger, the stretching of a rubber band, the squeezing of a lump of clay, the compression of a gas, and the stirring of a fluid.

When you do work on something, you transfer energy to that something. For instance, consider a case in which you push on a cart that is initially at rest. Within your body, you convert chemical potential energy into mechanical energy, which, by pushing the cart, you give to the cart. After you have been pushing on it for a while, the cart is moving, meaning that it has some kinetic energy. So, in the end, the cart has some kinetic energy that was originally chemical potential energy stored in you. Energy has been transferred from you to the cart.

In the case of the cart, what happens to the energy that you transfer to the cart is clear. But how about the case of a deformable system whose center of mass stays put? When you do work on such a system, you transfer energy to that system. So what happens to the energy? Experimentally, we find that the energy becomes part of the internal energy of the system. The internal energy of the system increases by an amount that is equal to the work done on the system.

This increase in the internal energy can be an increase in the internal potential energy, an increase in the internal kinetic energy, or both. An increase in the internal kinetic energy would manifest itself as an increase in temperature.

Doing work on a system represents the second way, which we have considered, of causing an increase in the internal energy of the system. The other way was for heat to flow into the system. The fact that doing work on a system and/or having heat flow into that system will increase the internal energy of that system, is represented, in equation form, by:

$$\Delta U = Q + W_{\text{IN}}$$

which we copy here for your convenience:

$$\Delta U = Q + W_{\text{IN}} \quad (37-1)$$

In this equation, ΔU is the change in the internal energy of the system, Q is the amount of heat that flows into the system, and W_{IN} is the amount of work that is done on the system. This equation is referred to as the *First Law of Thermodynamics*. Chemists typically write it without the subscript IN on the symbol W representing the work done on the system. (The subscript IN is there to remind us that the W_{IN} represents a transfer of energy *into* the system. In the chemistry convention, it is understood that W represents the work done on the system—no subscript is necessary.)

Historically, physicists and engineers have studied and developed thermodynamics with the goal of building a better heat engine, a device, such as a steam engine, designed to produce work from heat. That is, a device for which heat goes in and work comes out. It is probably for this reason that physicists and engineers almost always write the first law as:

$$\Delta U = Q - W \quad (37-2)$$

where the symbol W represents the amount of work done *by* the system on the external world. (This is just the opposite of the chemistry convention.) Because this is a physics course, this ($\Delta U = Q - W$) is the form in which the first law appears on your formula sheet. I suggest making the first law as explicit as possible by writing it as $\Delta U = Q_{\text{IN}} - W_{\text{OUT}}$ or, better yet:

$$\Delta U = Q_{\text{IN}} + W_{\text{IN}} \quad (37-3)$$

In this form, the equation is saying that you can increase the internal energy of a system by causing heat to flow into that system and/or by doing work on that system. Note that any one of the quantities in the equation can be negative. A negative value of Q_{IN} means that heat actually flows out of the system. A negative value of W_{IN} means that work is actually done by the system on the surroundings. Finally, a negative value of ΔU means that the internal energy of the system decreases.

Again, the real tip here is to use subscripts and common sense. Write the First Law of Thermodynamics in a manner consistent with the facts that heat or work *into* a system will *increase* the internal energy of the system, and heat or work *out of* the system will *decrease* the internal energy of the system.